

PŘÍČINKOVÉ ČARY

PŘÍČINKOVÉ ČÁRY

- PŘÍDAVEK (PŘÍČINEK)
OD JEDNOTKOVÉ SÍLY

PŘÍČINKOVÉ ČÁRY

- PŘÍDAVEK (PŘÍČINEK)
OD JEDNOTKOVÉ SÍLY

1) REAKCE

PŘÍČINKOVÉ ČÁRY

- PŘÍDAVEK (PŘÍČINEK)
OD JEDNOTKOVÉ SÍLY

1) REAKCE

a) MOMENTOVÁ

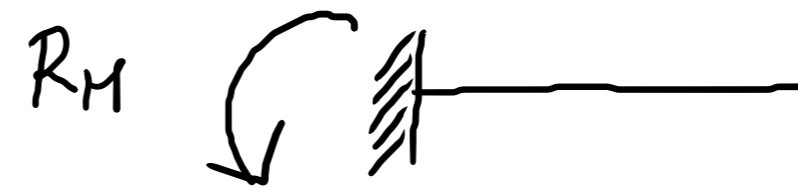

PŘÍČINKOVÉ ČÁRY

- PŘÍDAVEK (PŘÍČINEK)
OD JEDNOTKOVÉ SÍLY

1) REAKCE

a) MOMENTOVÁ

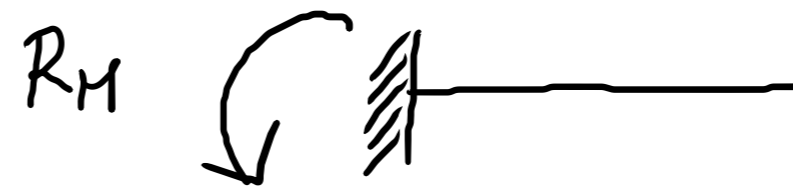

b) SÍLOVÁ

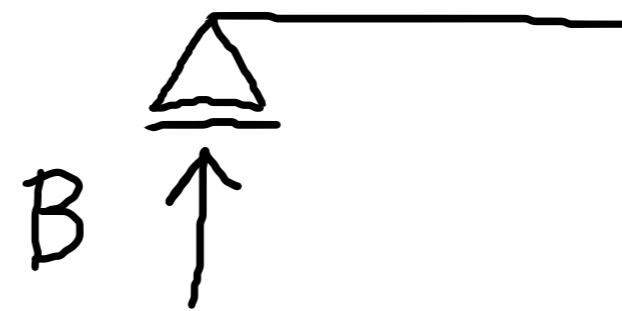

PŘÍČINKOVÉ ČÁRY

- PŘÍDAVEK (PŘÍČINEK)
OD JEDNOTKOVÉ SÍLY

1) REAKCE

a) MOMENTOVÁ

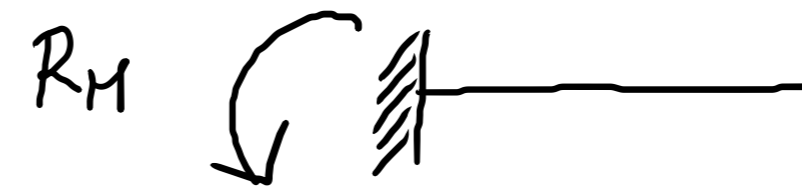

b) SÍLOVÁ

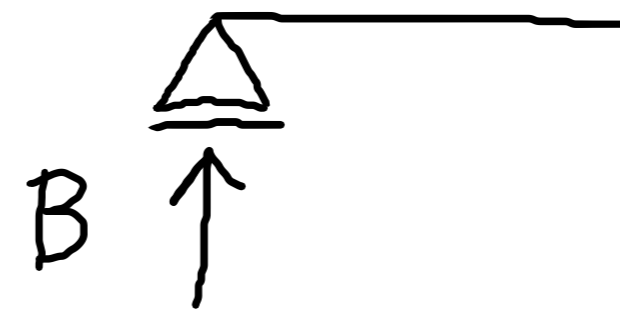

2) VNITŘNÍ SÍLY

PŘÍČINKOVÉ ČÁRY

- PŘÍDAVEK (PŘÍČINEK)
OD JEDNOTKOVÉ SÍLY

1) REAKCE

a) MOMENTOVÁ

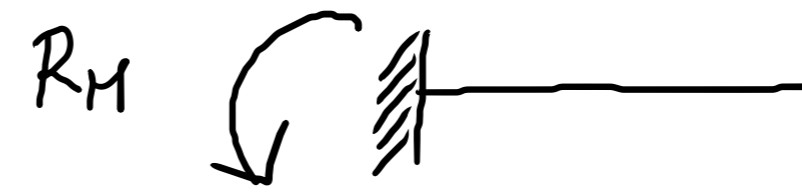

b) SÍLOVÁ

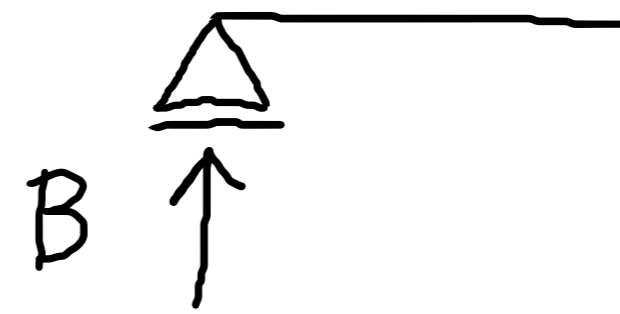

2) VNITŘNÍ SÍLY

a) V_x

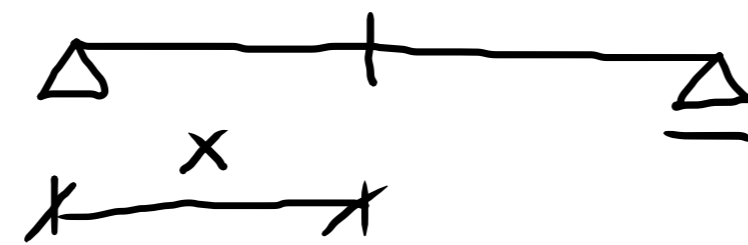

PŘÍČINKOVÉ ČÁRY

- PŘÍDAVEK (PŘÍČINEK)
OD JEDNOTKOVÉ SÍLY

1) REAKCE

a) MOMENTOVÁ

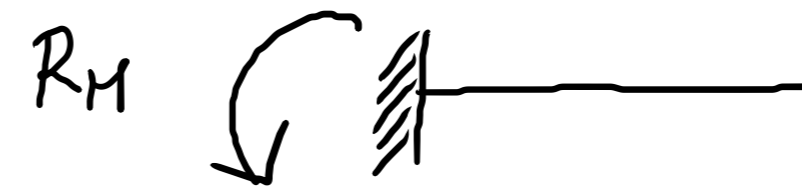

b) SÍLOVÁ

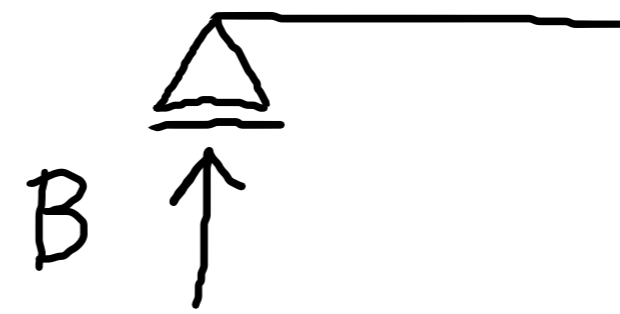

2) VNITŘNÍ SÍLY

a) V_x

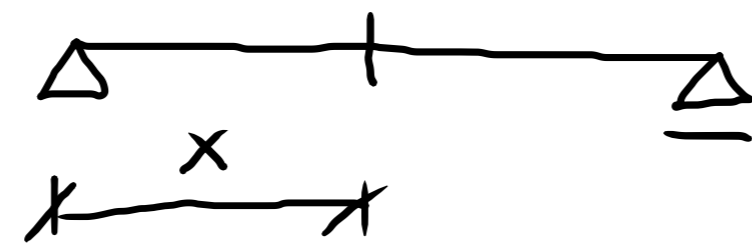

b) M_x

PŘÍČINKOVÉ ČÁRY

- PŘÍDAVEK (PŘÍČINEK)
OD JEDNOTKOVÉ SÍLY

1) REAKCE

a) MOMENTOVÁ

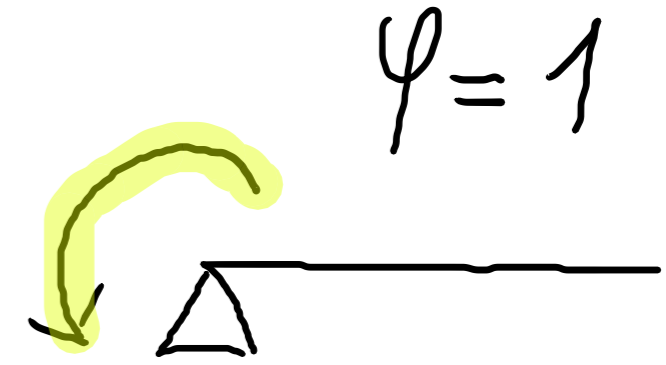

b) SÍLOVÁ

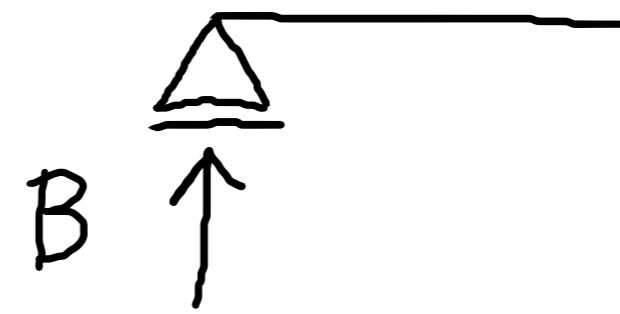

2) VNITŘNÍ SÍLY

a) V_x

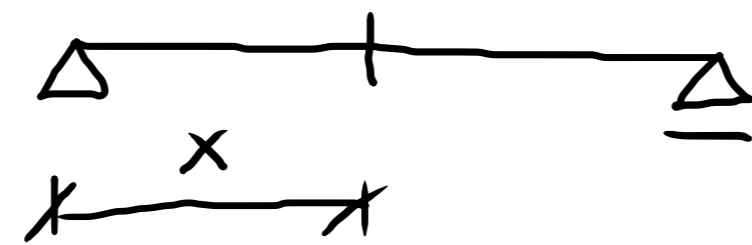

b) M_x

PŘÍČINKOVÉ ČÁRY

- PŘÍDAVEK (PŘÍČINEK)
OD JEDNOTKOVÉ SÍLY

1) REAKCE

a) MOMENTOVÁ

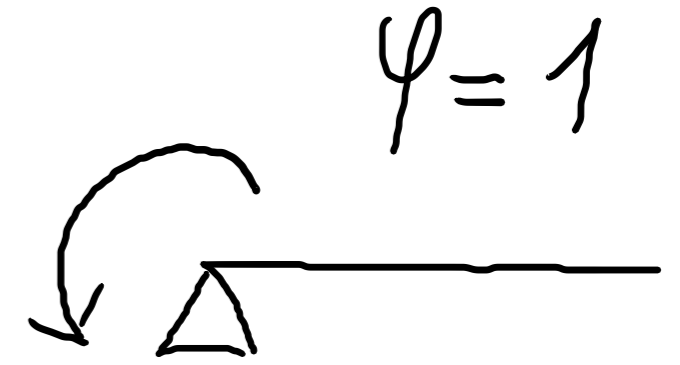
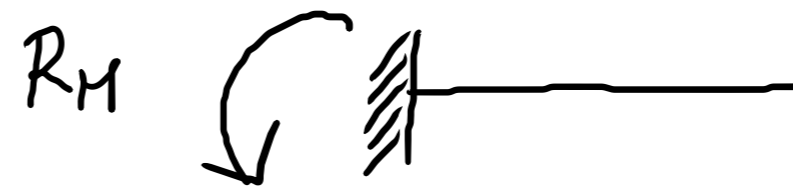

b) SÍLOVÁ

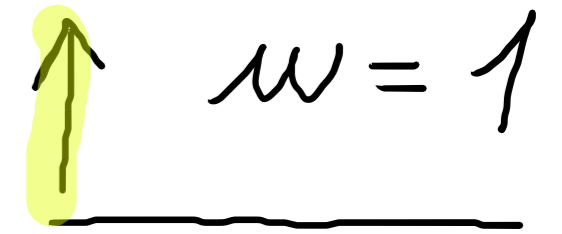
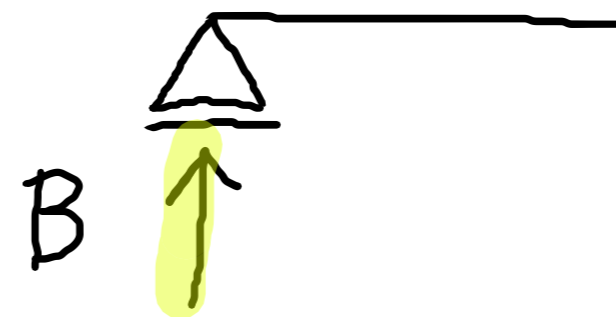

2) VNITŘNÍ SÍLY

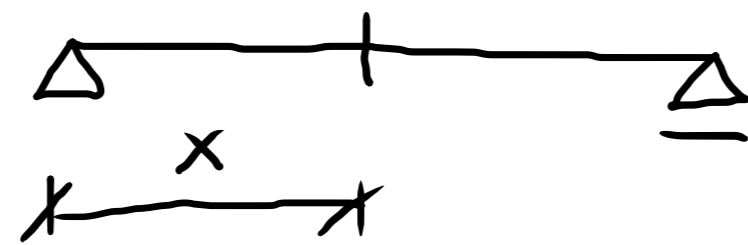

a) V_x

b) M_x

PŘÍČINKOVÉ ČÁRY

- PŘÍDAVEK (PŘÍČINEK)
OD JEDNOTKOVÉ SÍLY

1) REAKCE

a) MOMENTOVÁ

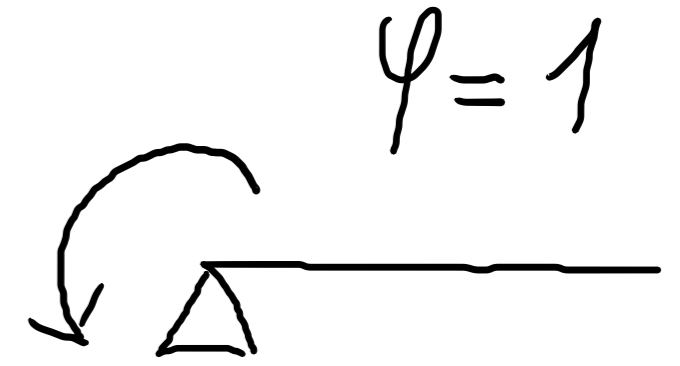

b) SÍLOVÁ

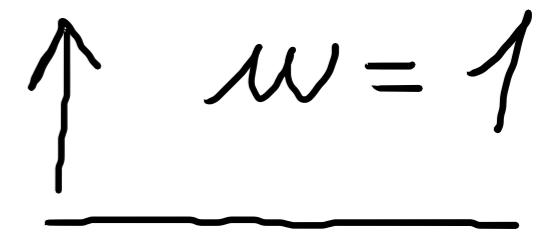
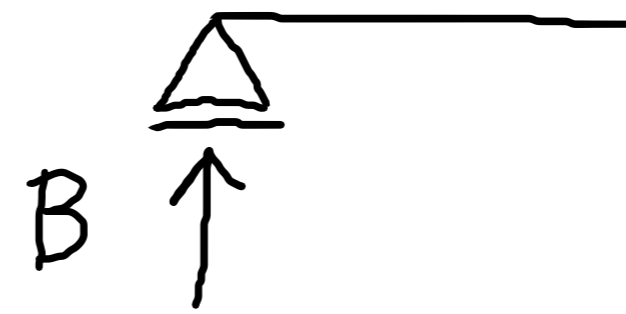

2) VNITŘNÍ SÍLY

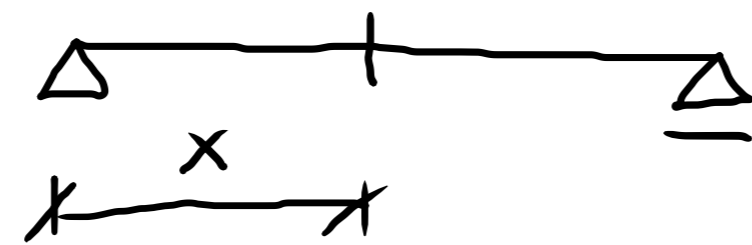

a) V_x

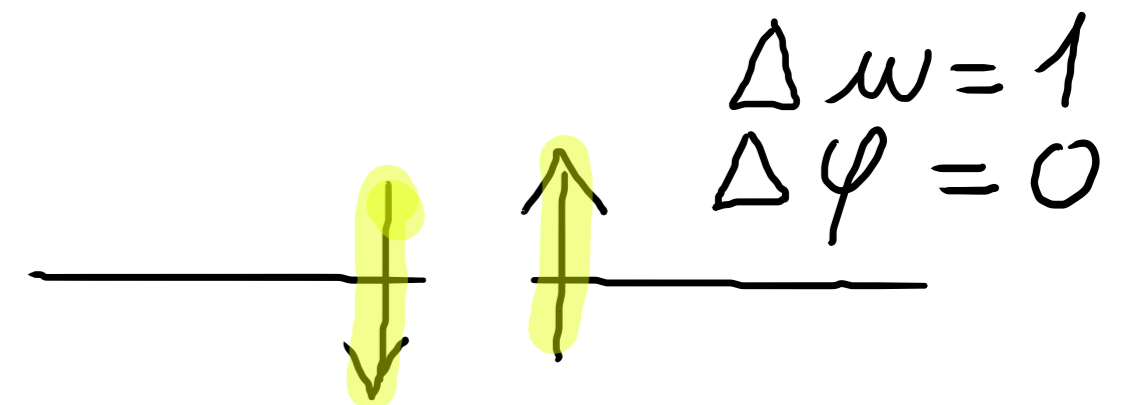

b) M_x

PŘÍČINKOVÉ ČÁRY

- PŘÍDAVEK (PŘÍČINEK)
OD JEDNOTKOVÉ SÍLY

1) REAKCE

a) MOMENTOVÁ

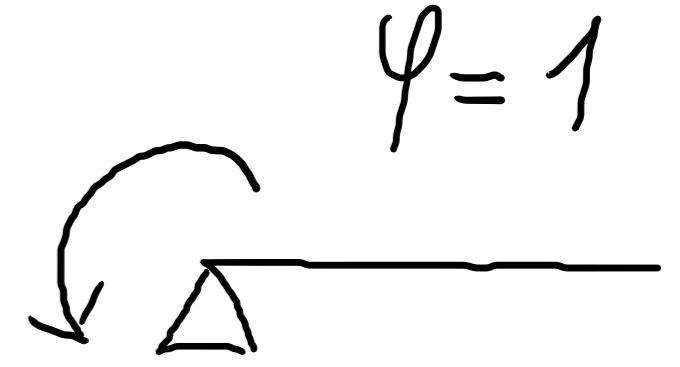

b) SÍLOVÁ

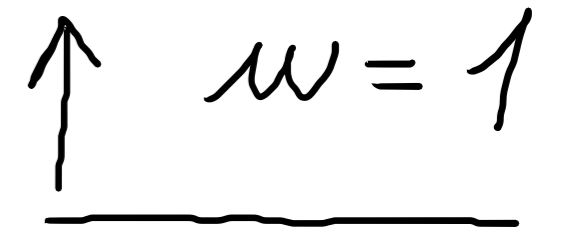
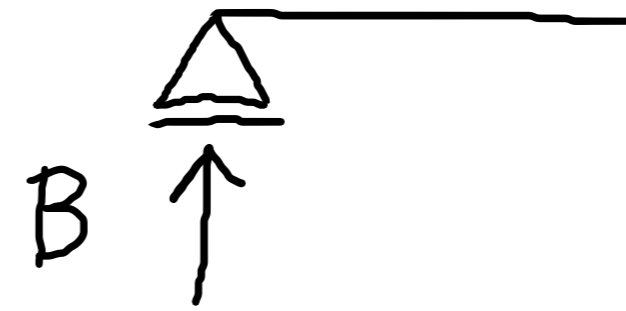

2) VNITŘNÍ SÍLY

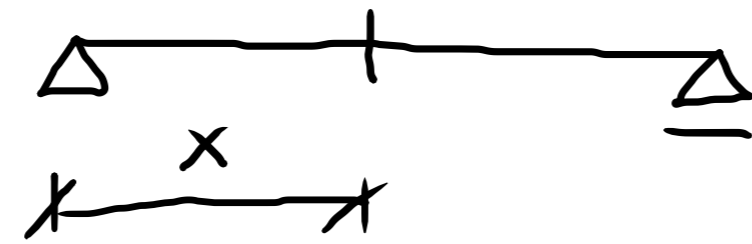

a) V_x

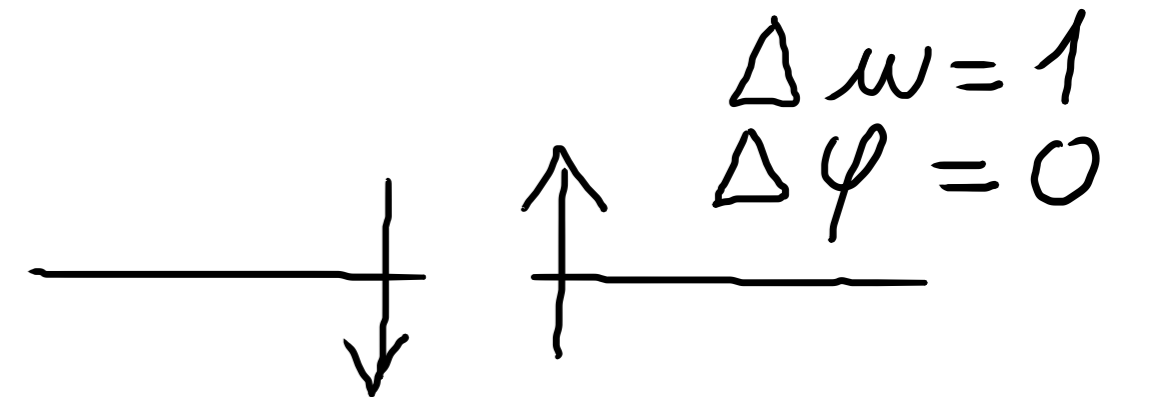

b) M_x

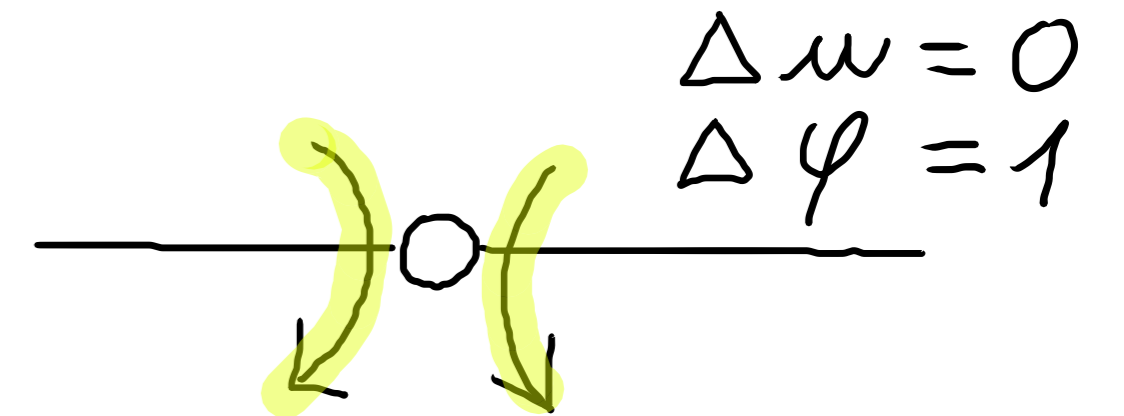

PŘÍČINKOVÉ ČÁRY

- PŘÍDAVEK (PŘÍČINEK)
OD JEDNOTKOVÉ SÍLY

1) REAKCE

a) MOMENTOVÁ

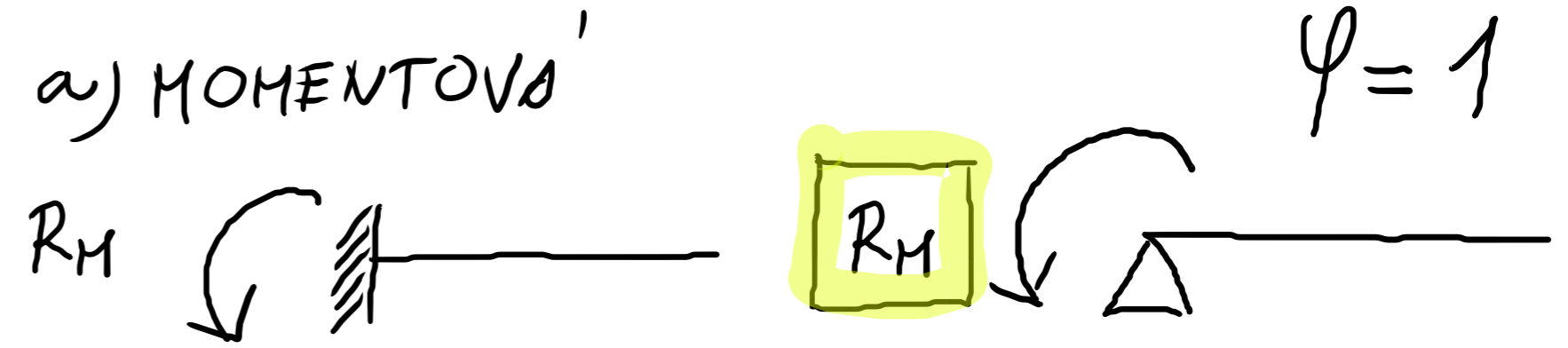

b) SÍLOVÁ

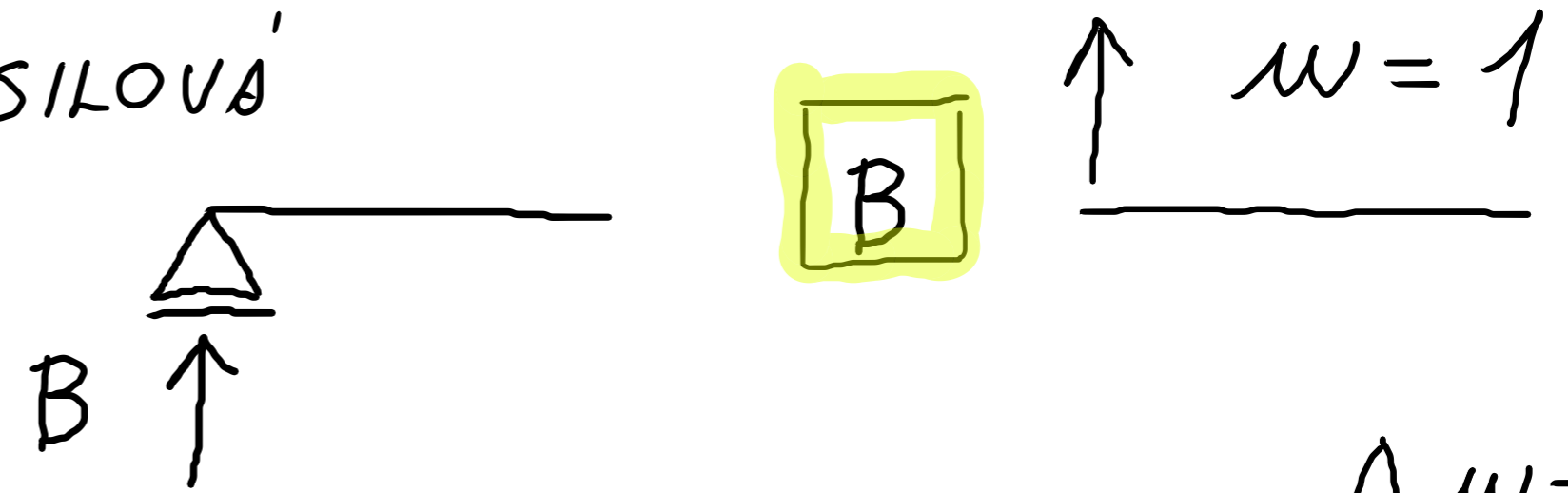

2) VNITŘNÍ SÍLY

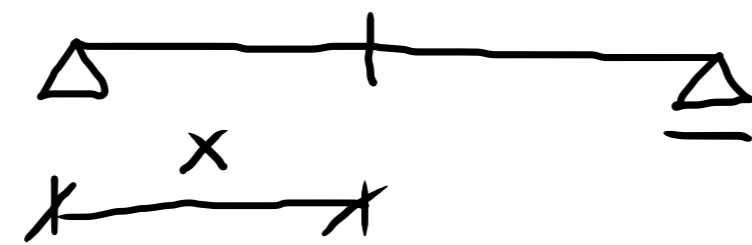

a) V_x

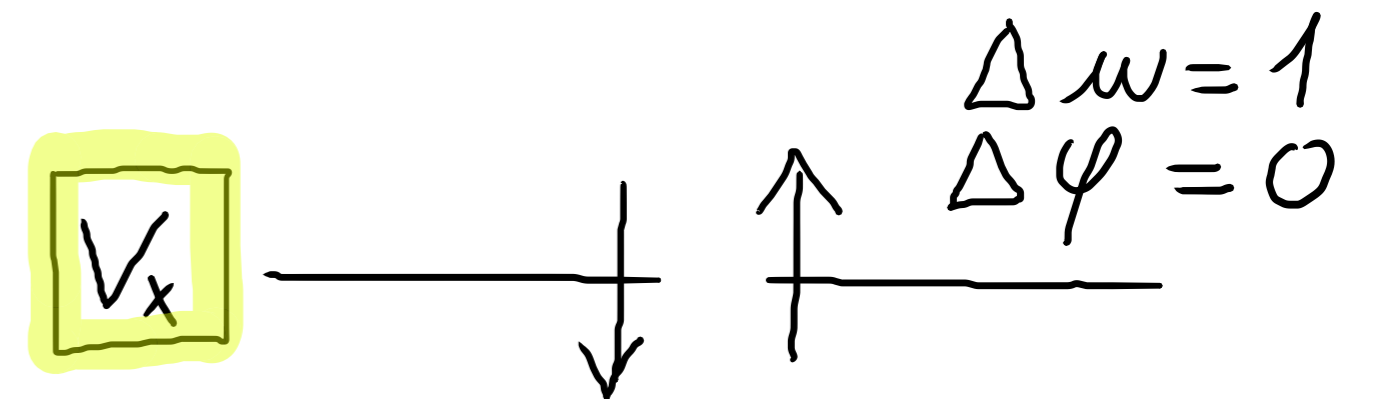

b) M_x

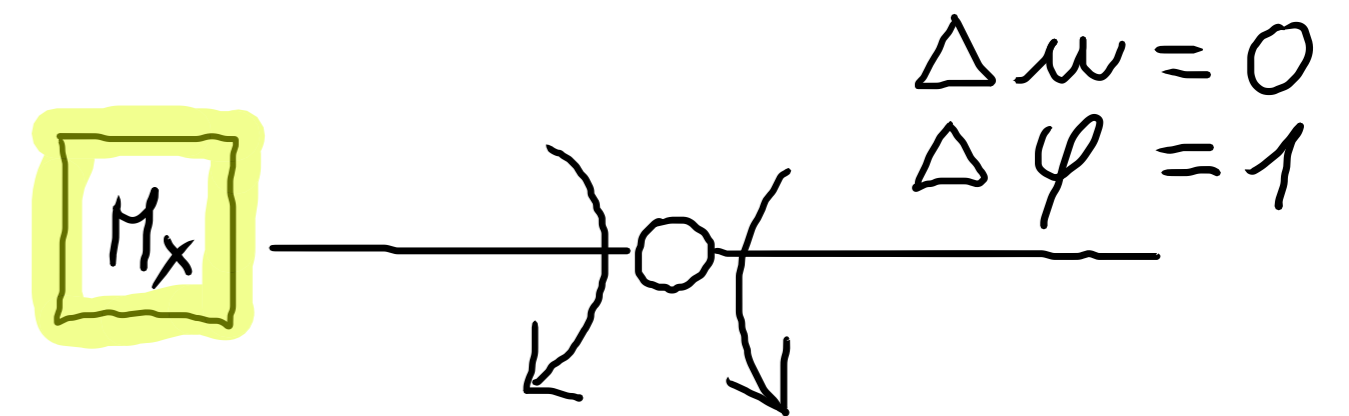

P.Č. - STATICKY URČITĚ KONSTRUKCE

P.Č. - STATICKY URČITĚ KONSTRUKCE

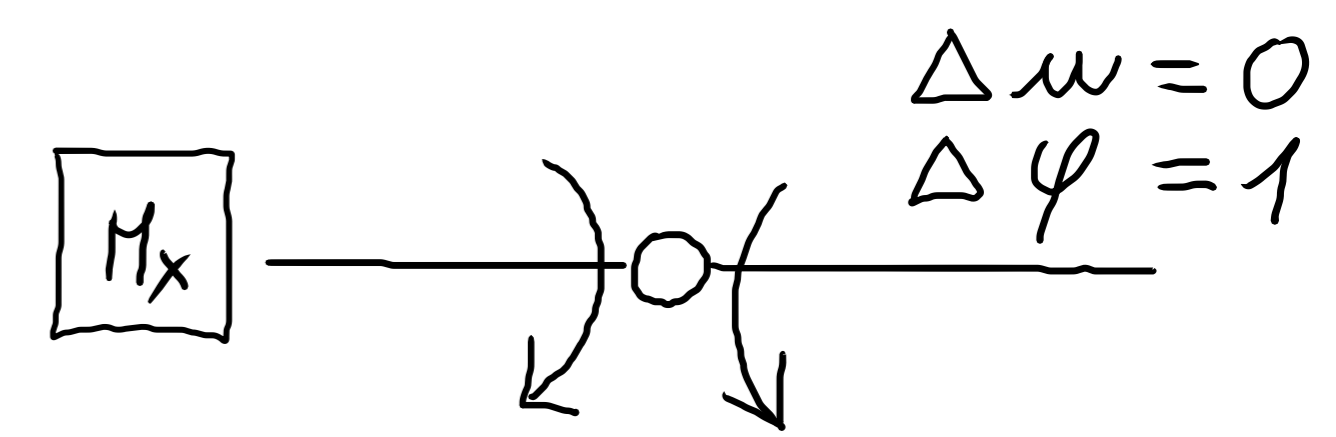
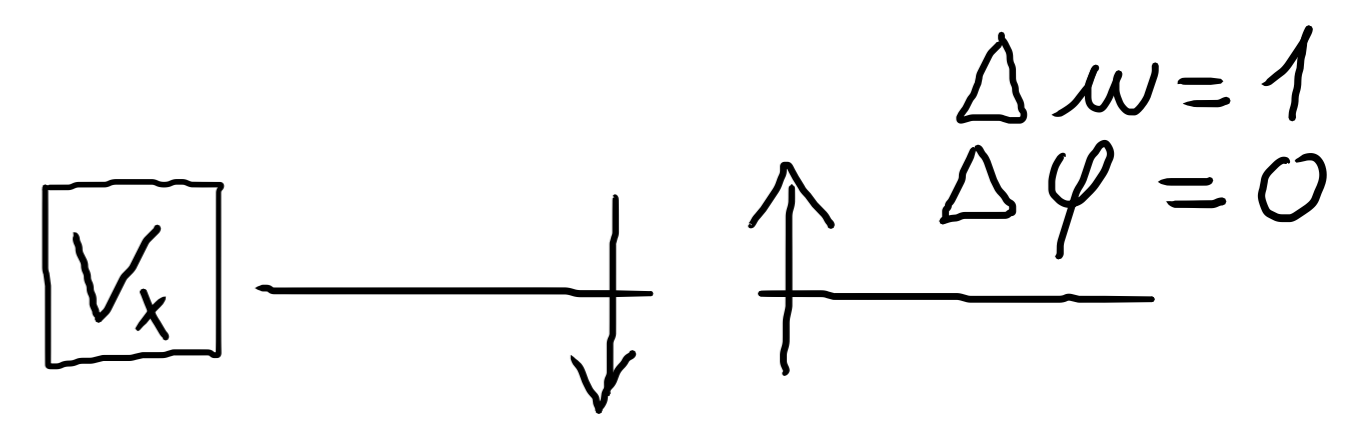
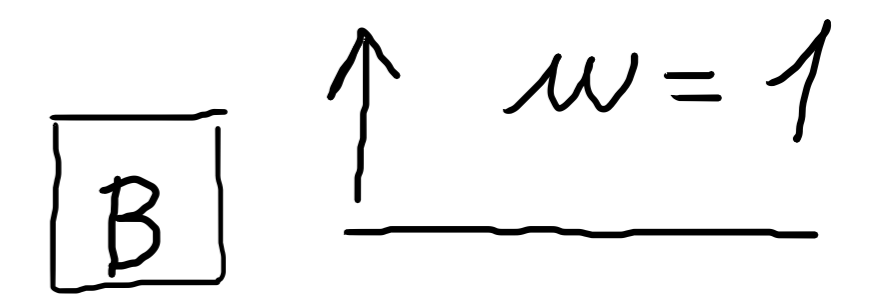
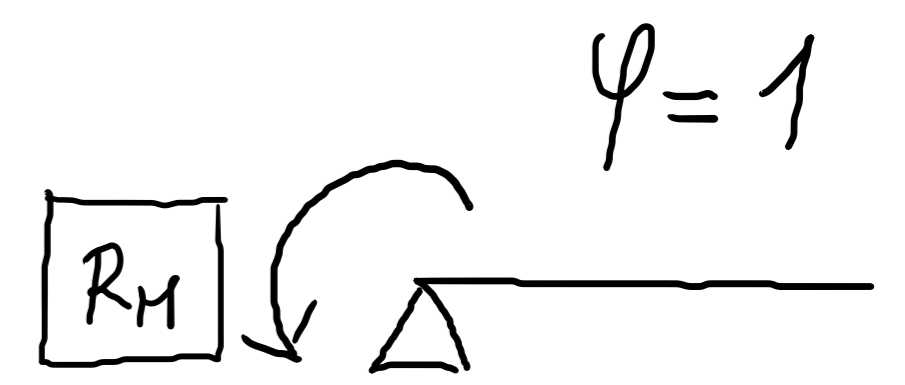

P.Č. - STATICKY URČITĚ KONSTRUKCE

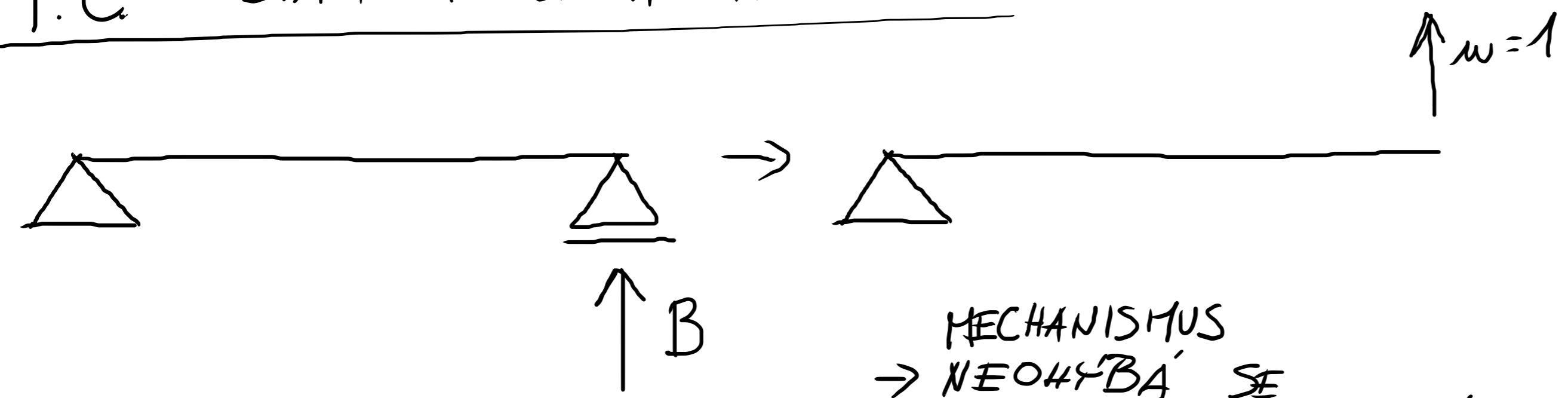

MECHANISMUS
 → NEOHYBÁ SE
 → MAX 1° (POUZE PŘÍMKY)
 (0, KONST., lin.)

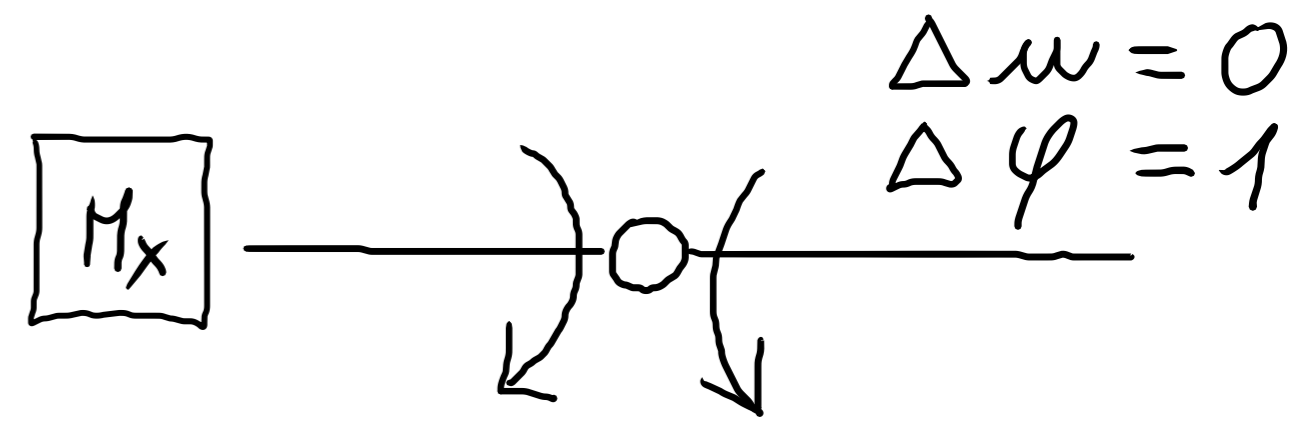
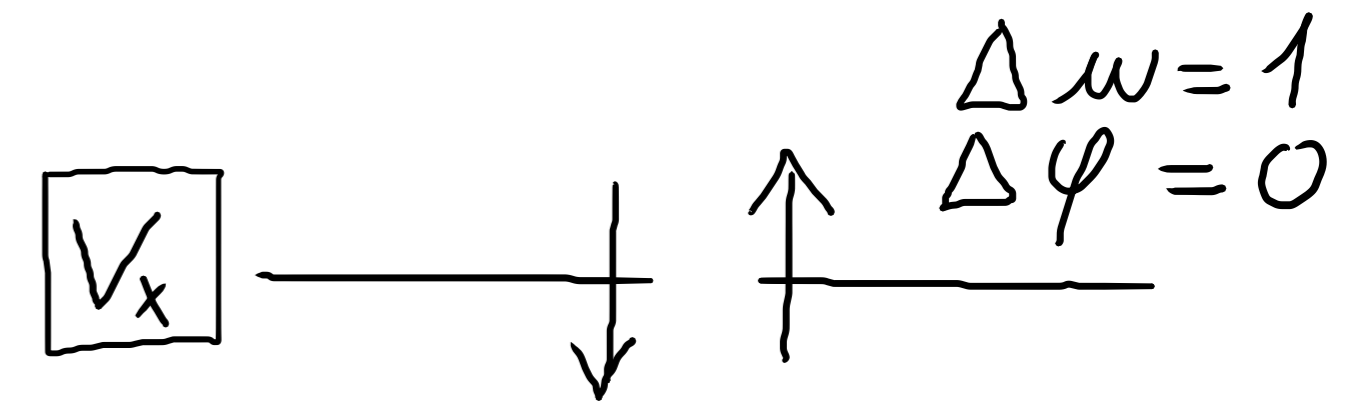
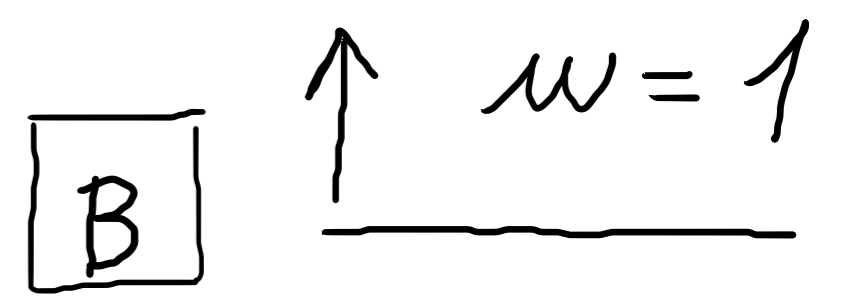
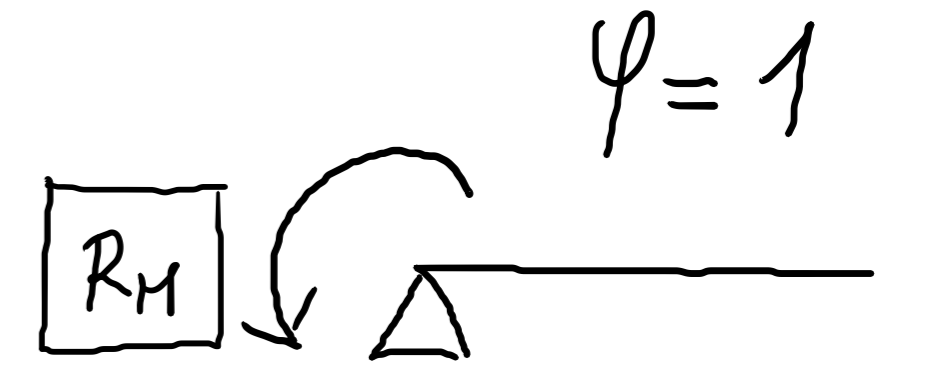

P.Č. - STATICKY URČITĚ KONSTRUKCE

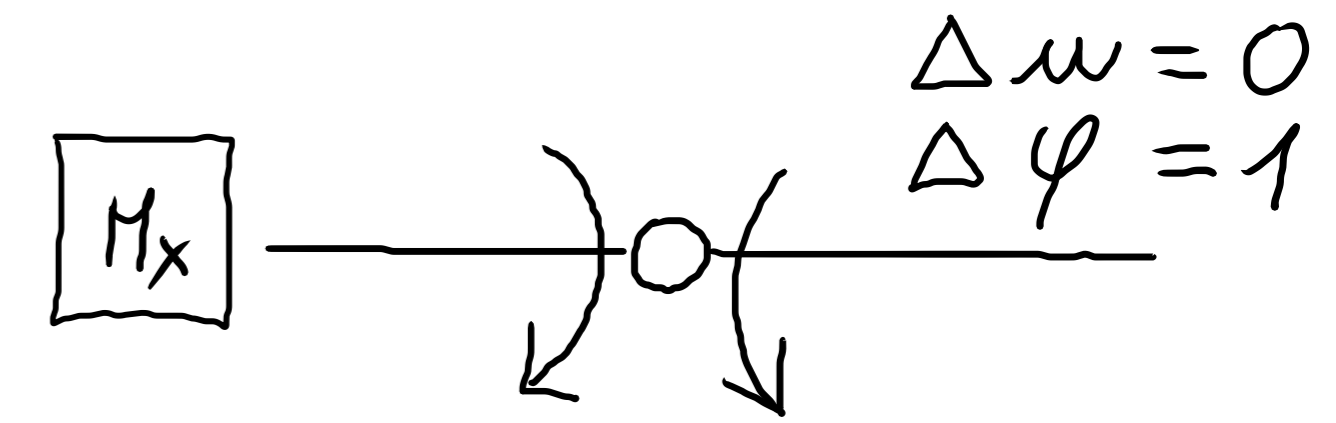
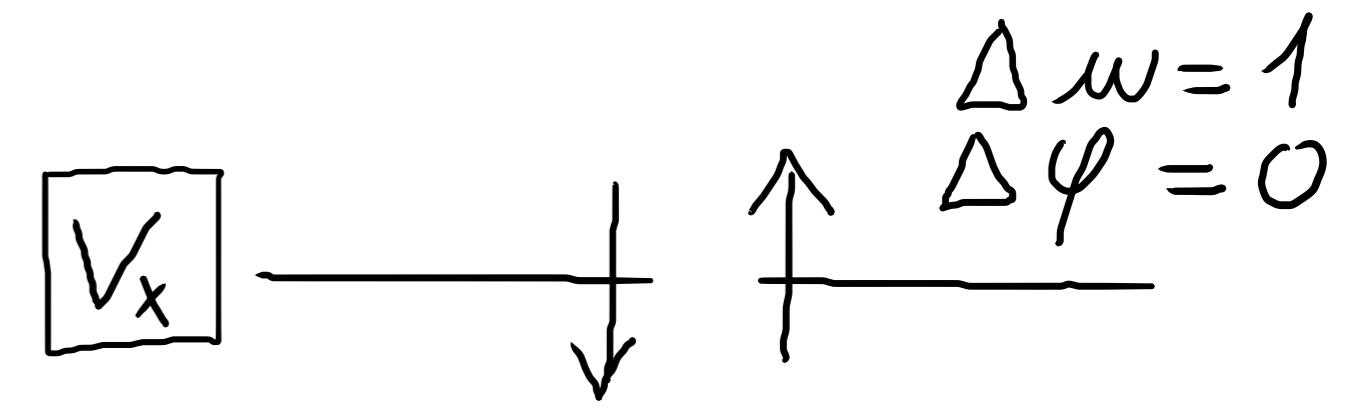
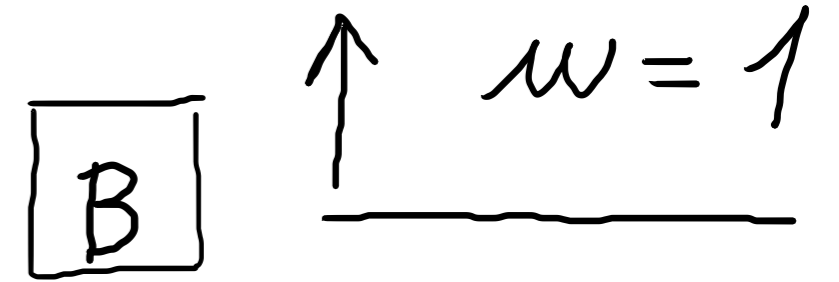
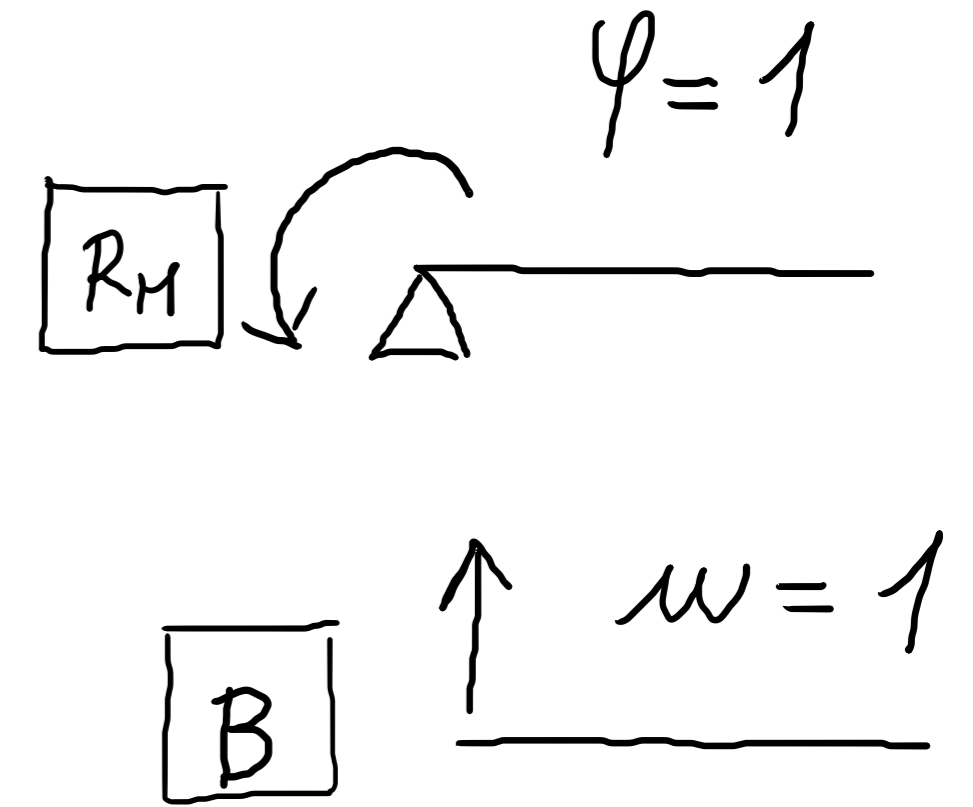
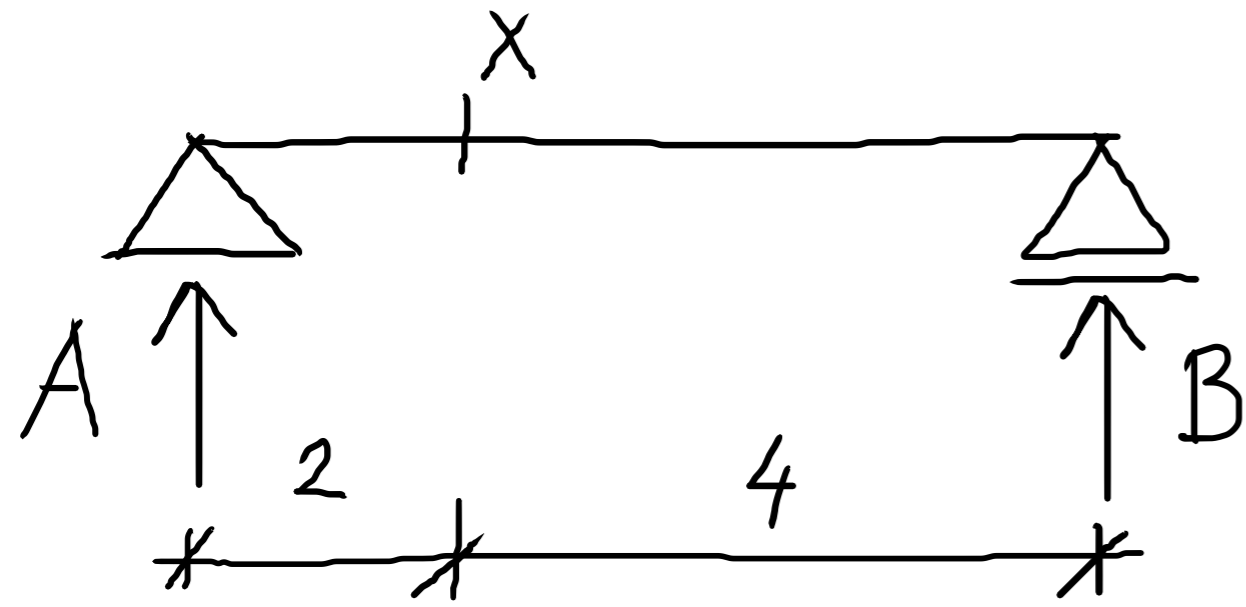

P.Č. - STATICKY URČITĚ KONSTRUKCE

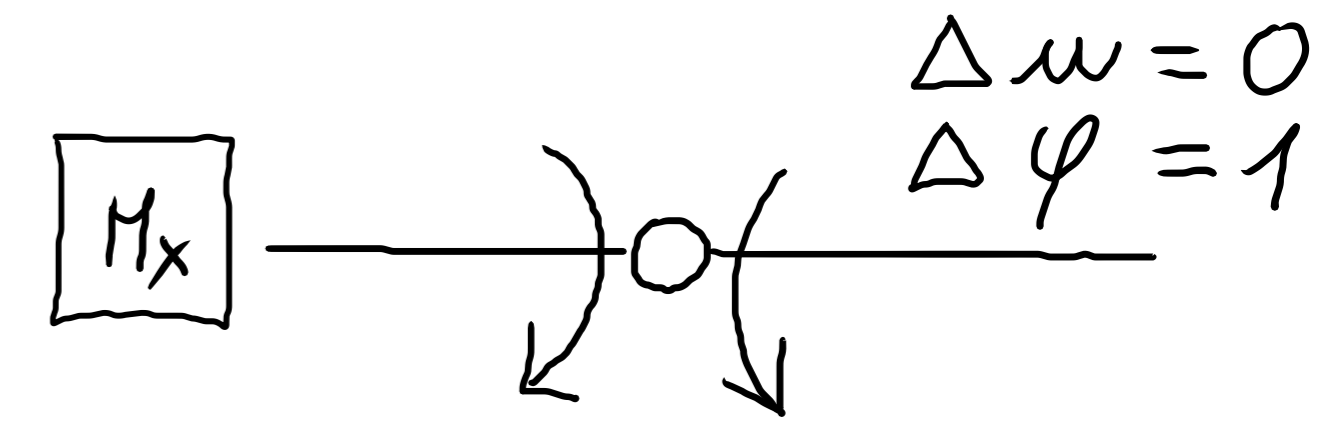
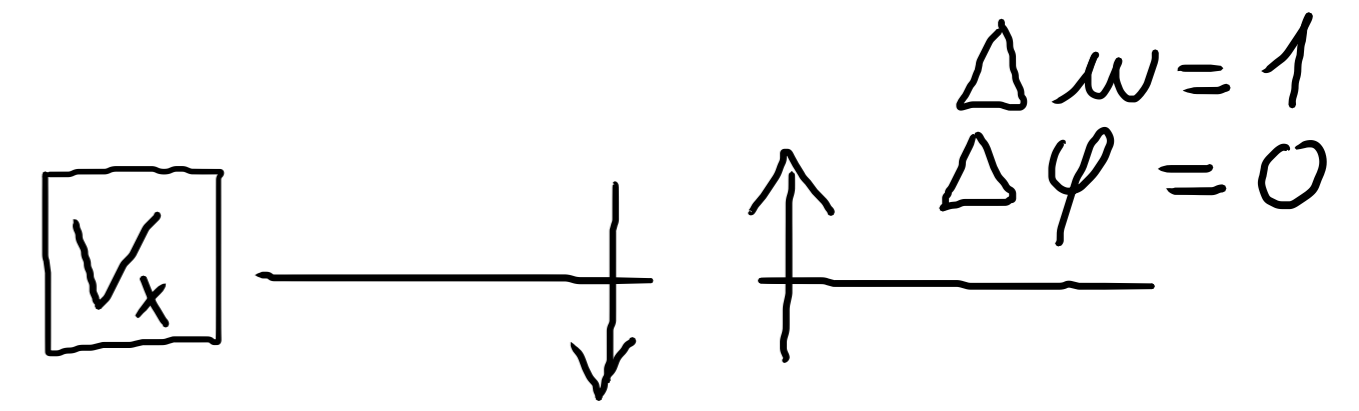
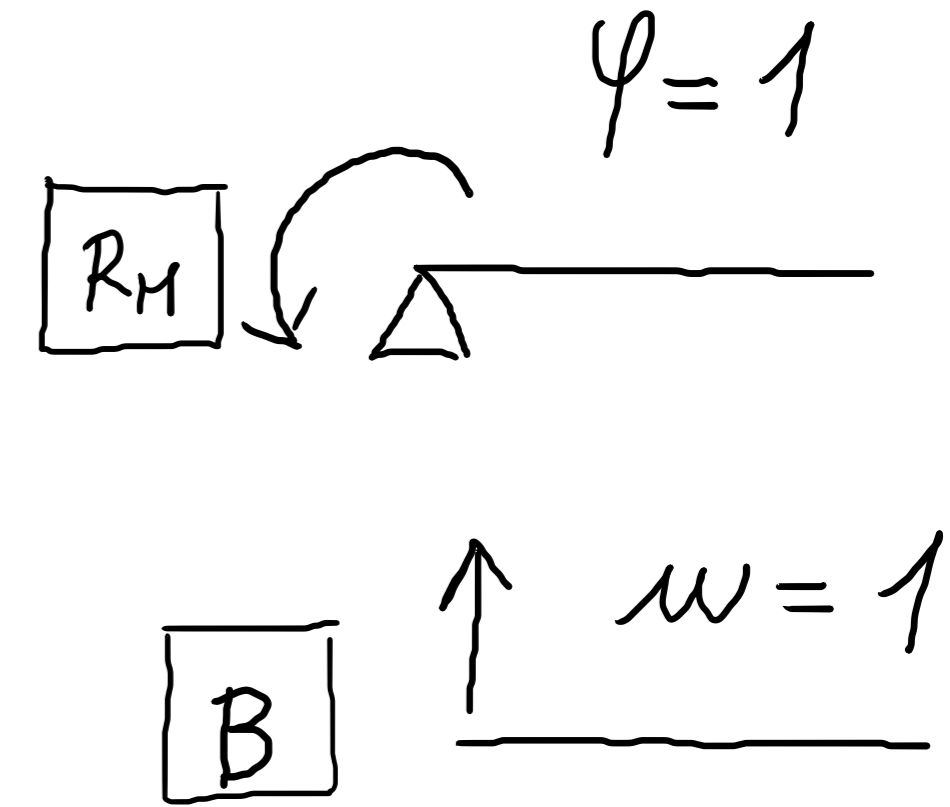
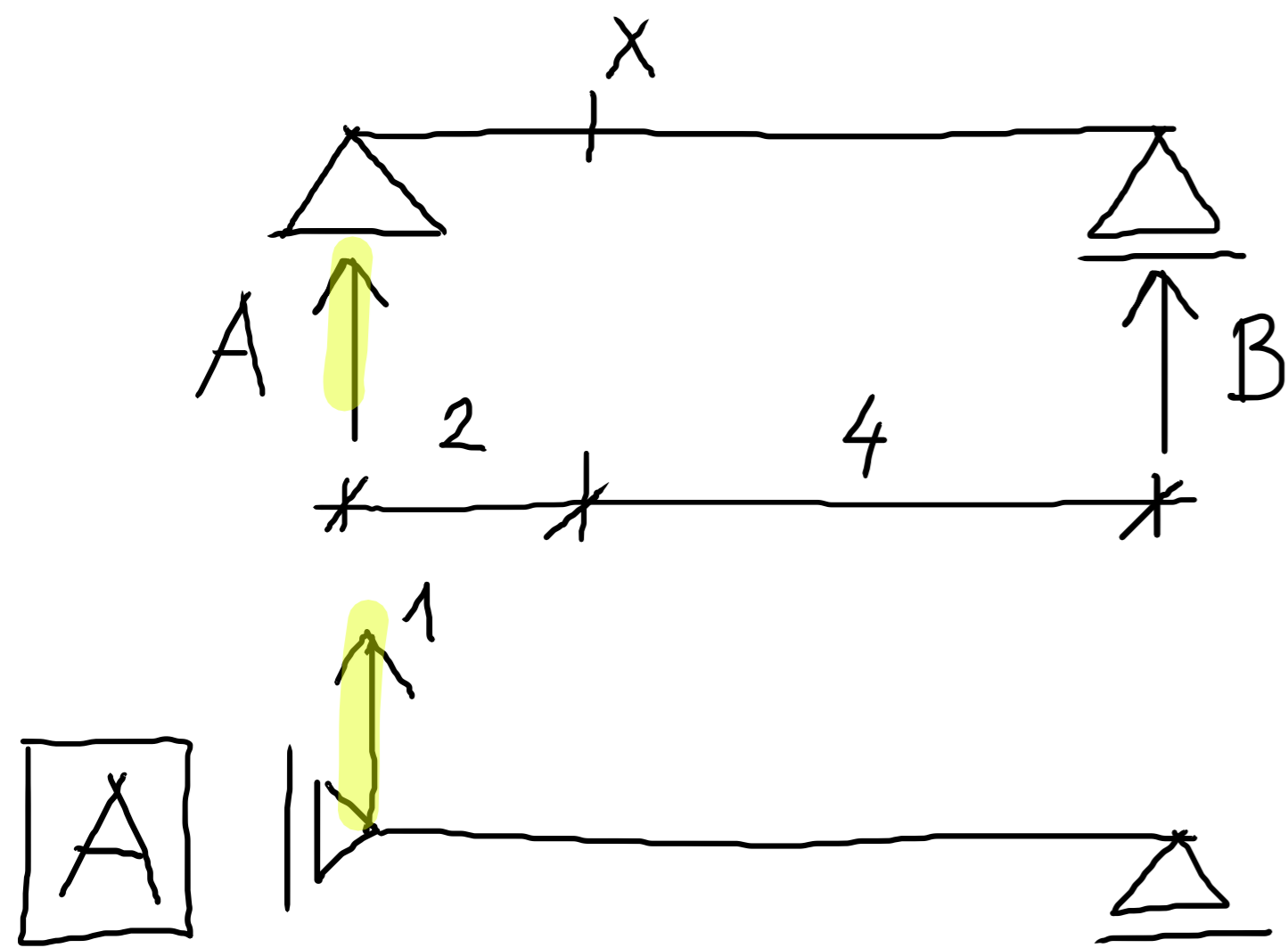

P.Č. - STATICKY URČITĚ KONSTRUKCE

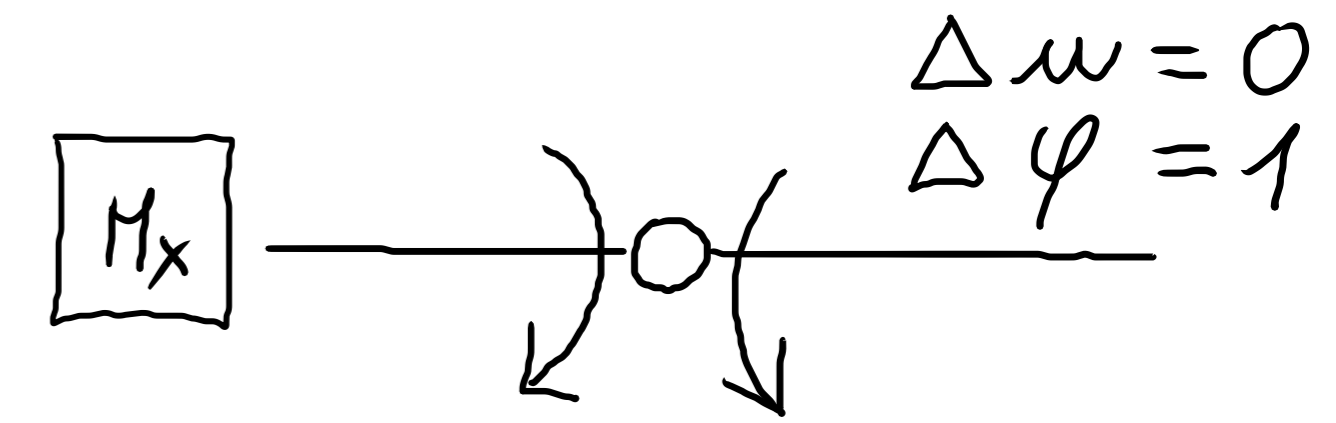
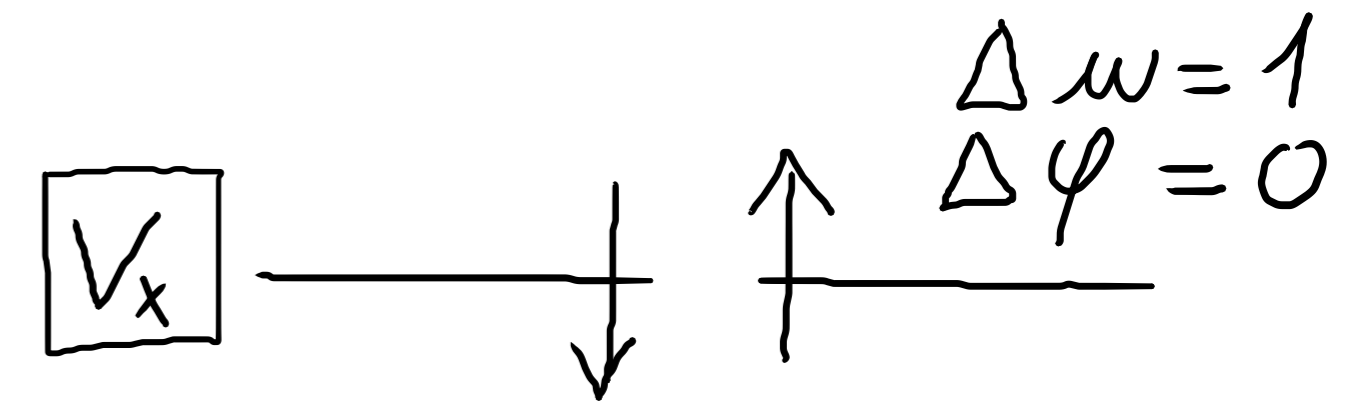
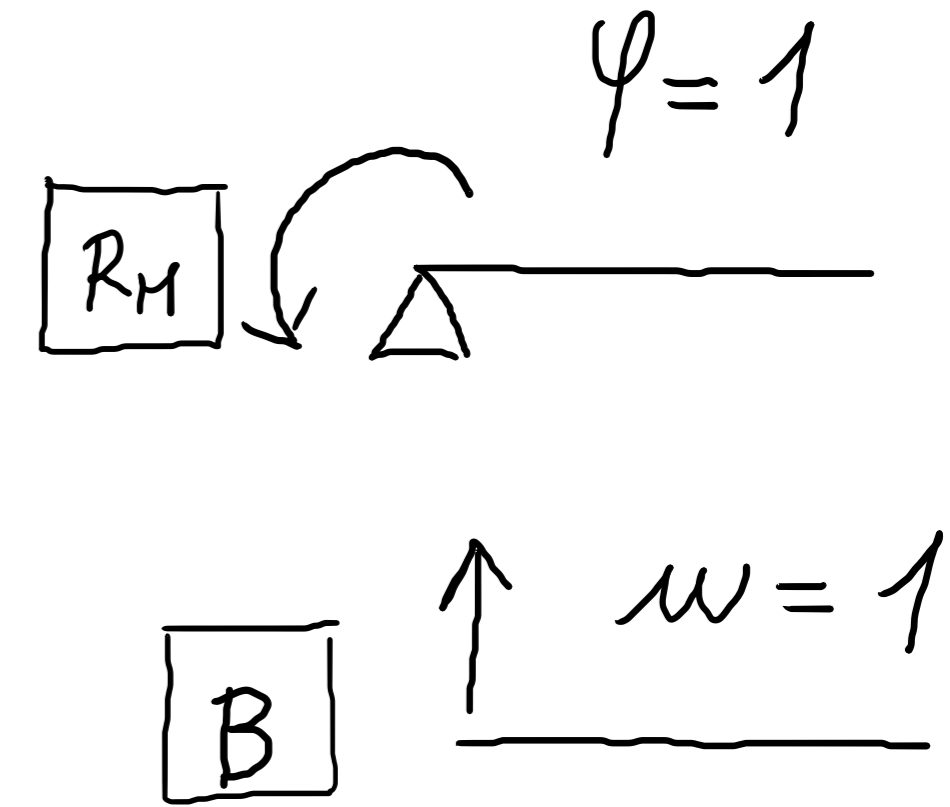
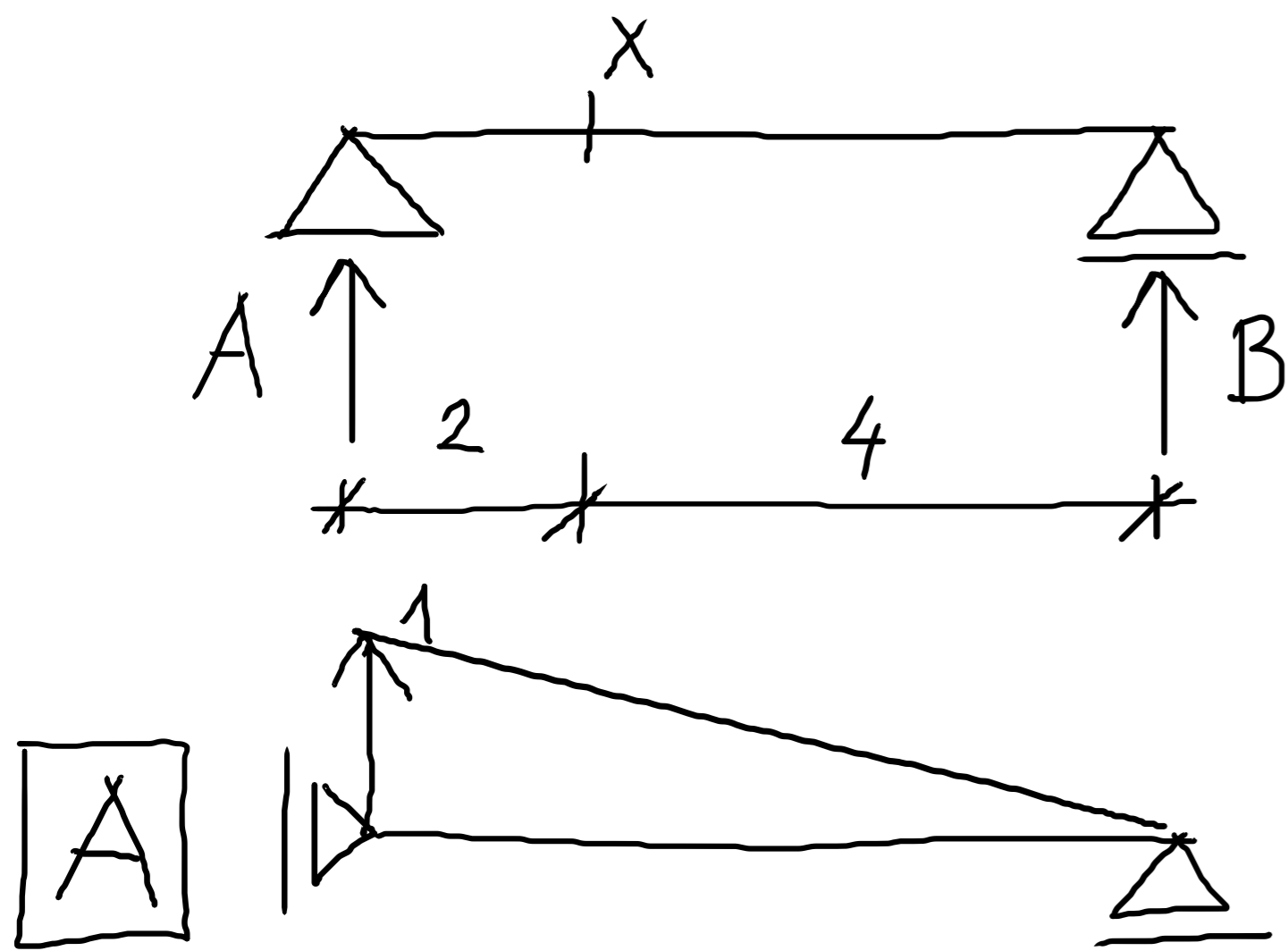

P.Č. - STATICKY URČITĚ KONSTRUKCE

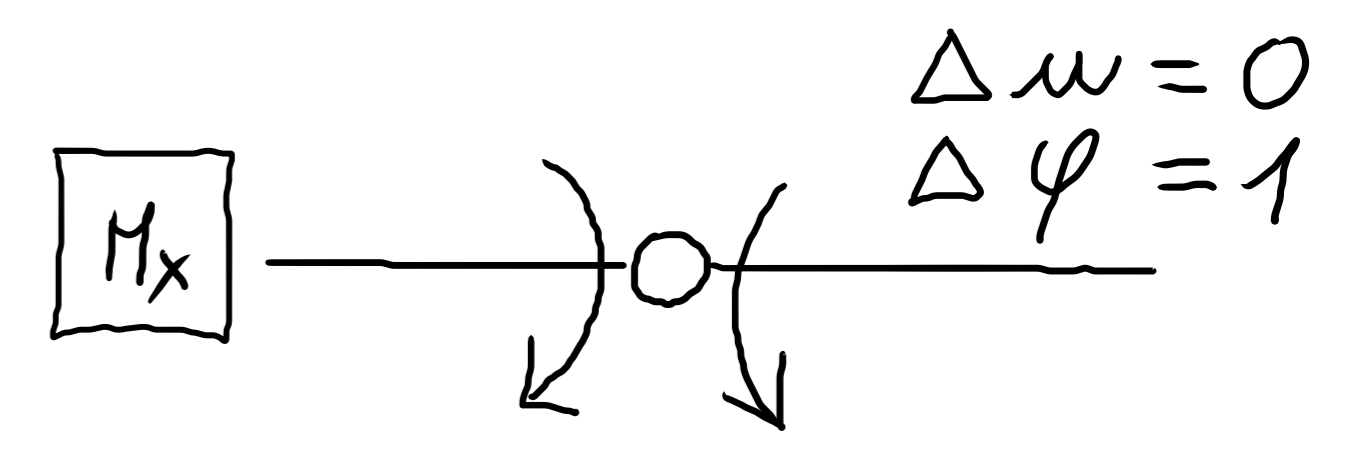
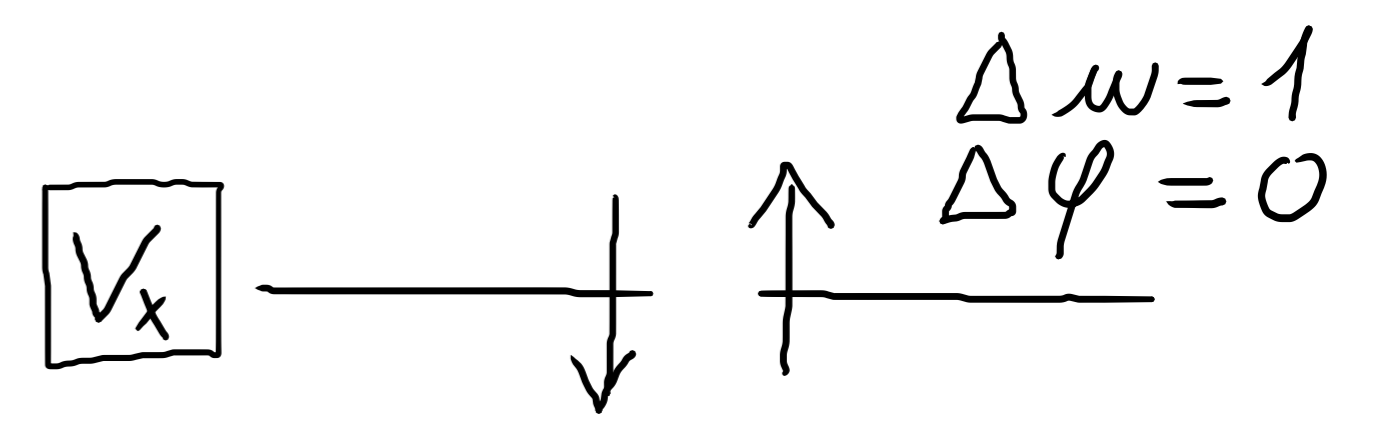
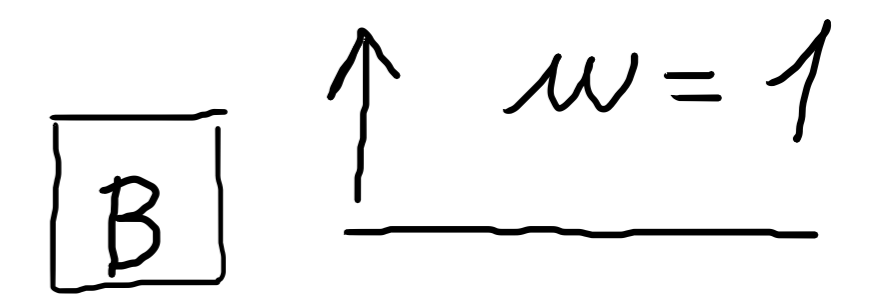
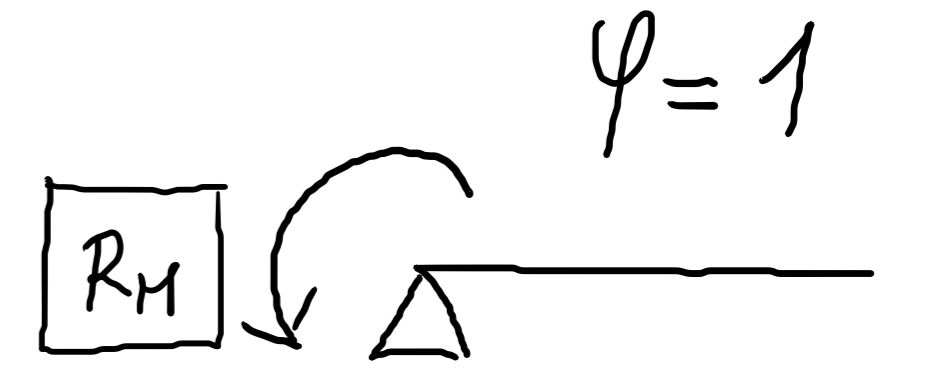
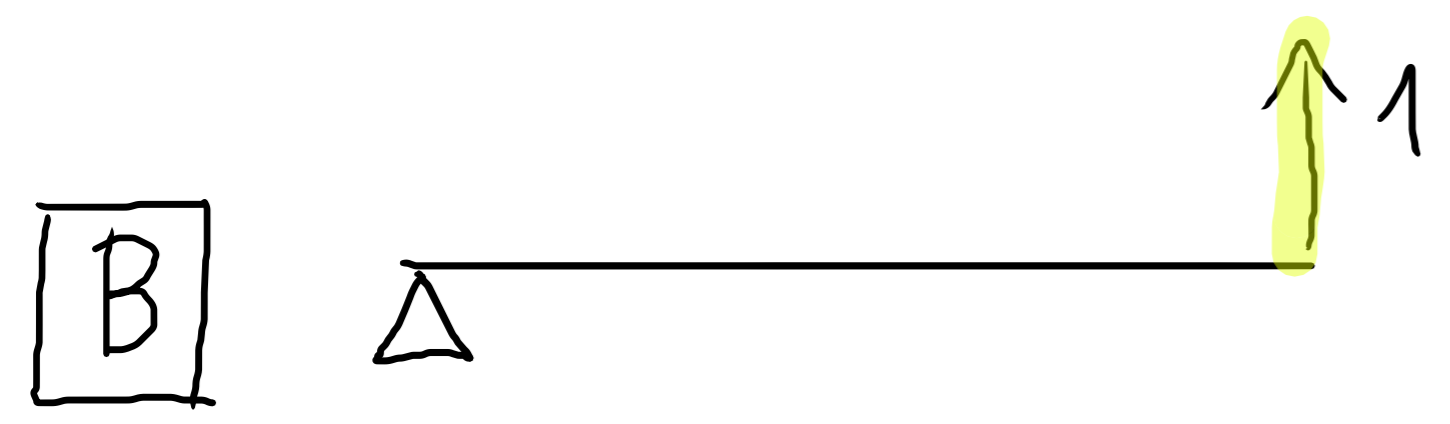
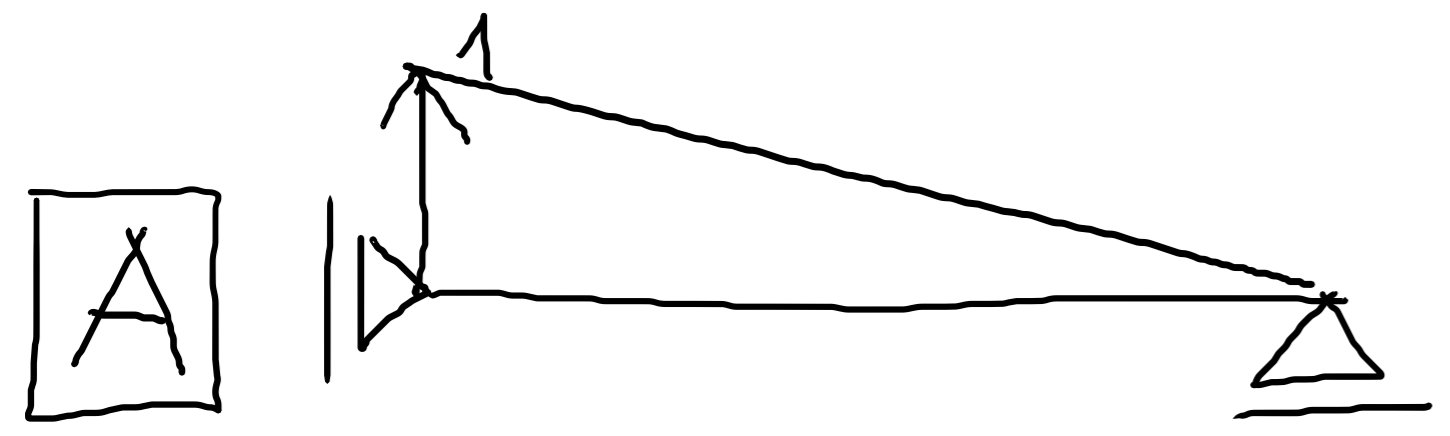
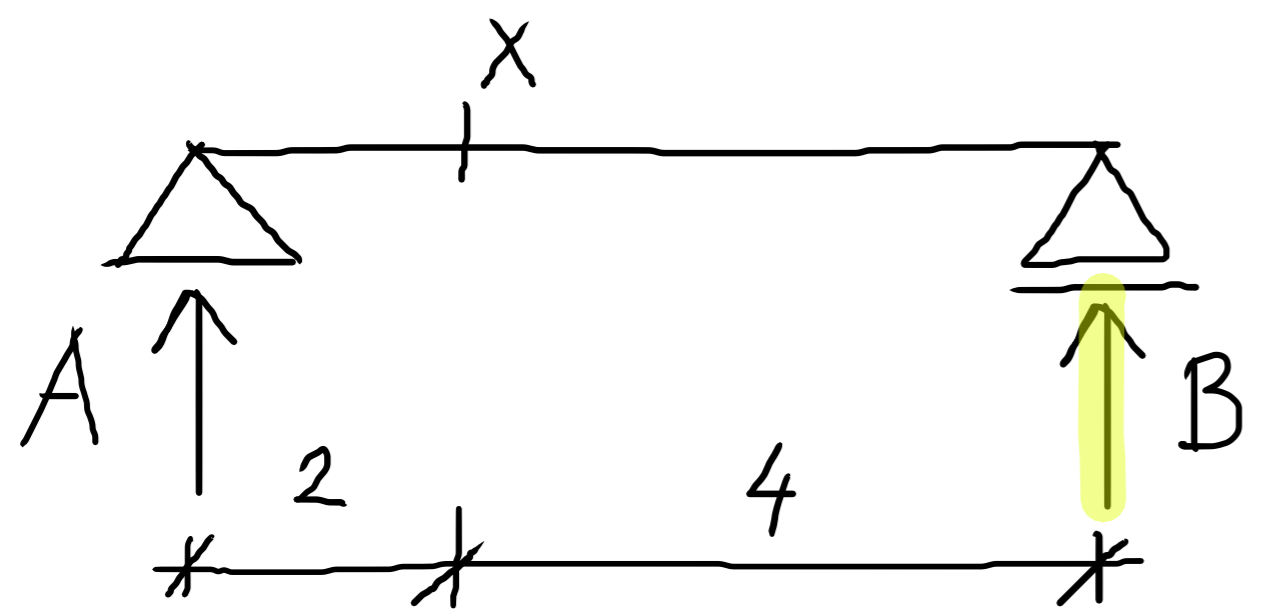

P.Č. - STATICKY URČITĚ KONSTRUKCE

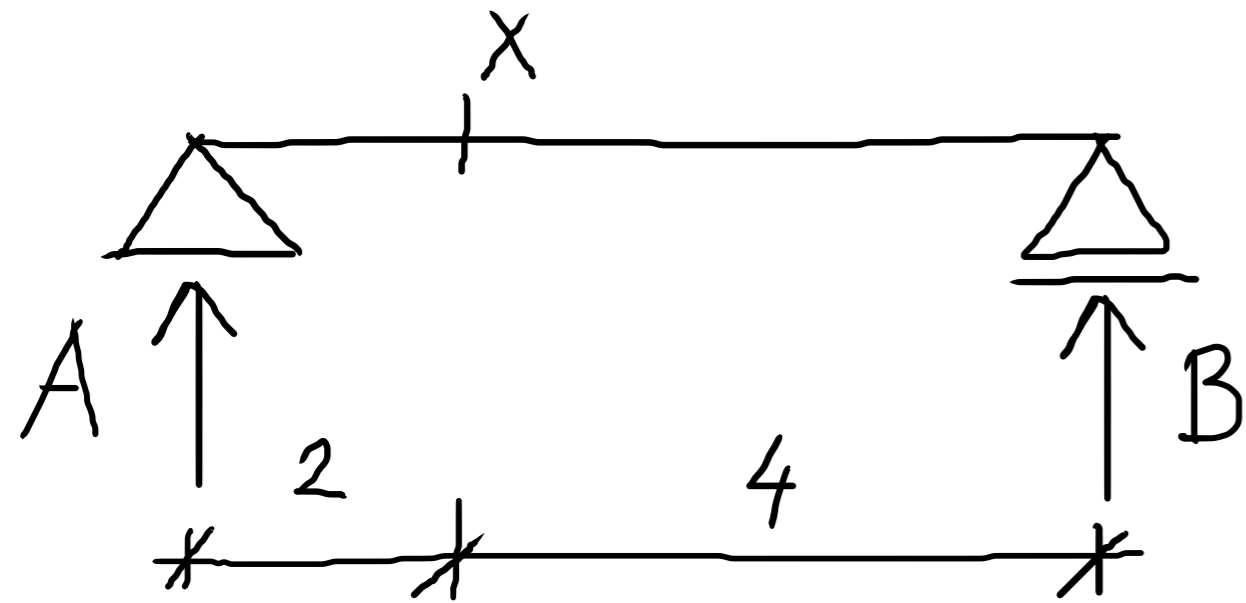

A

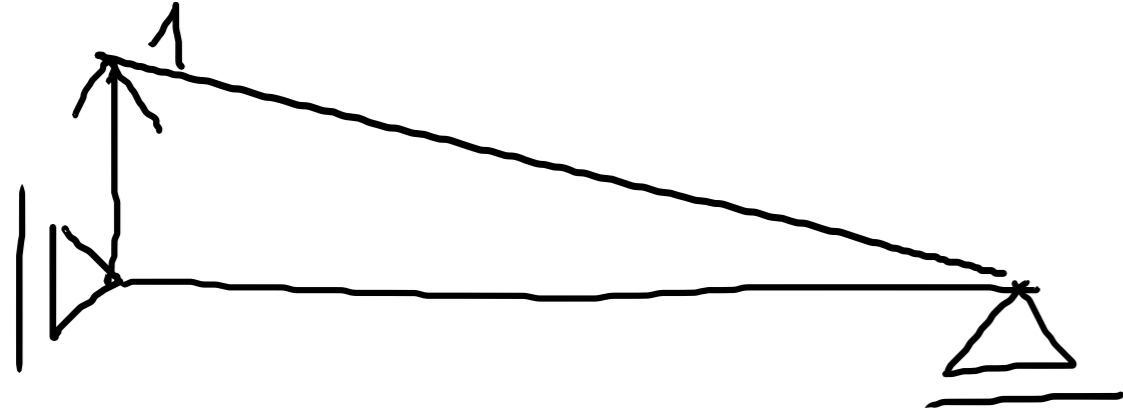

B

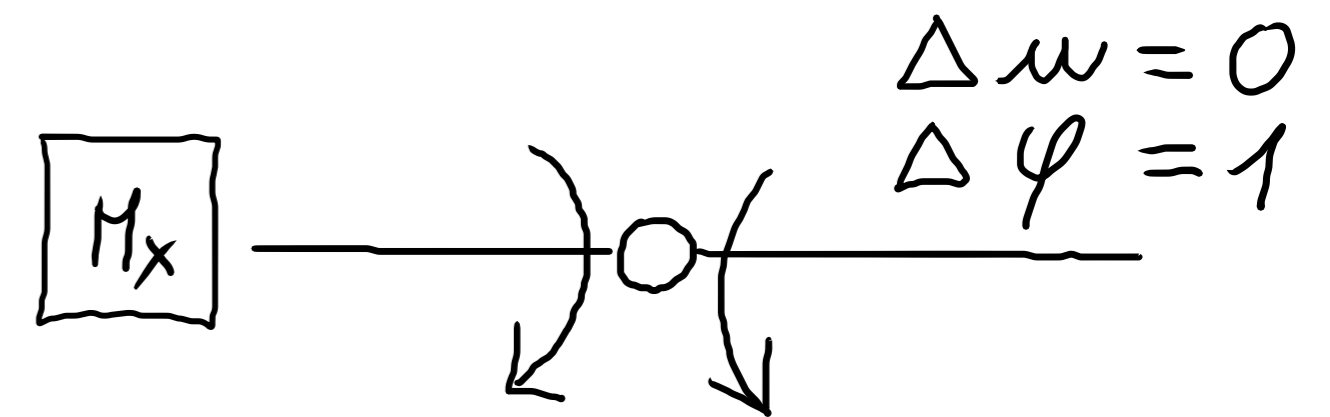
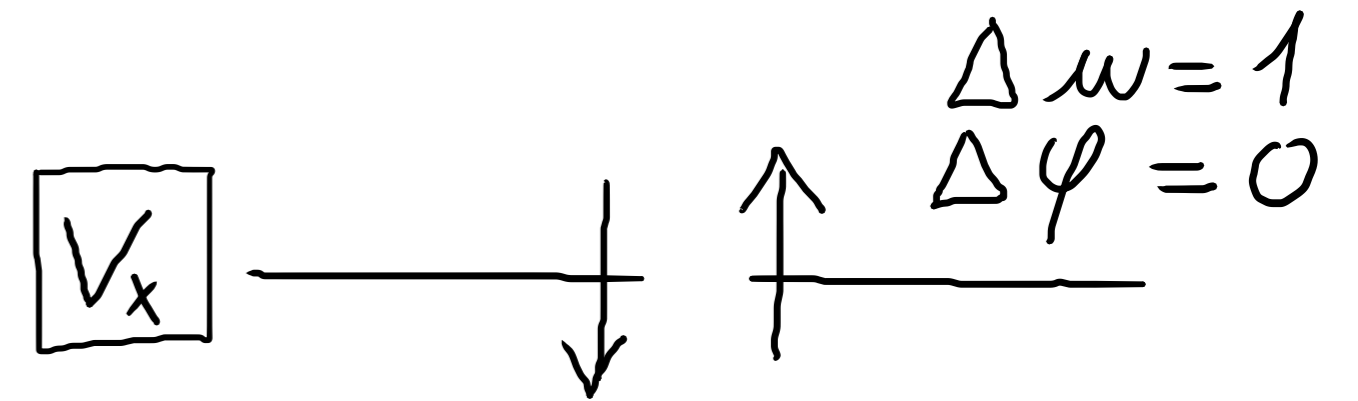

P.Č. - STATICKY URČITĚ KONSTRUKCE

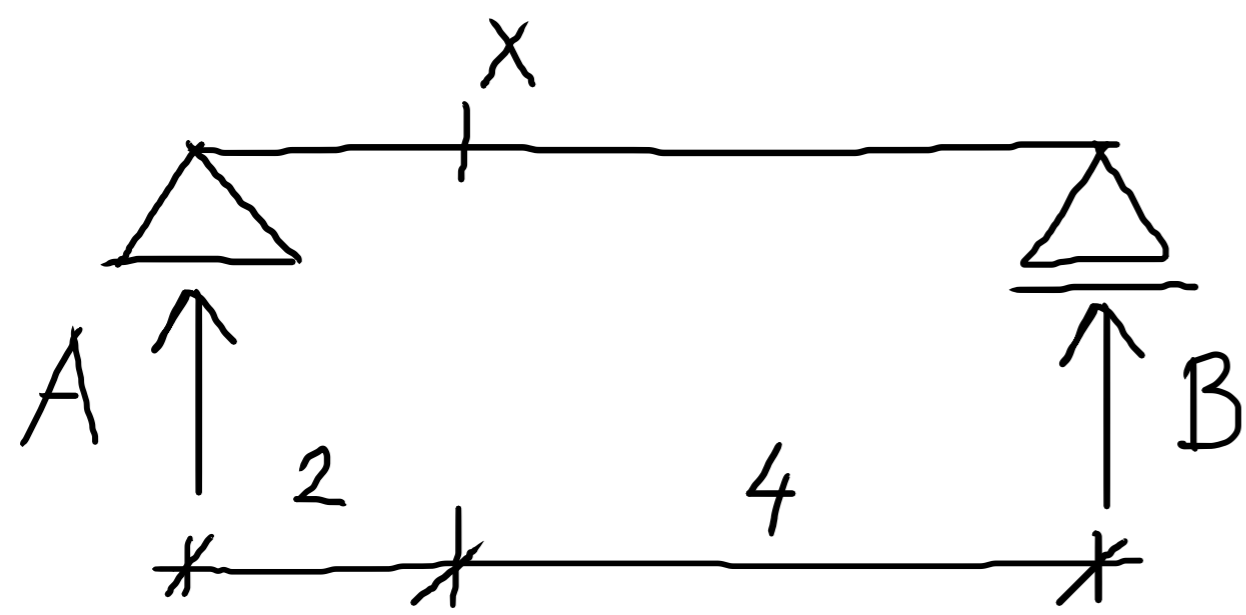

A

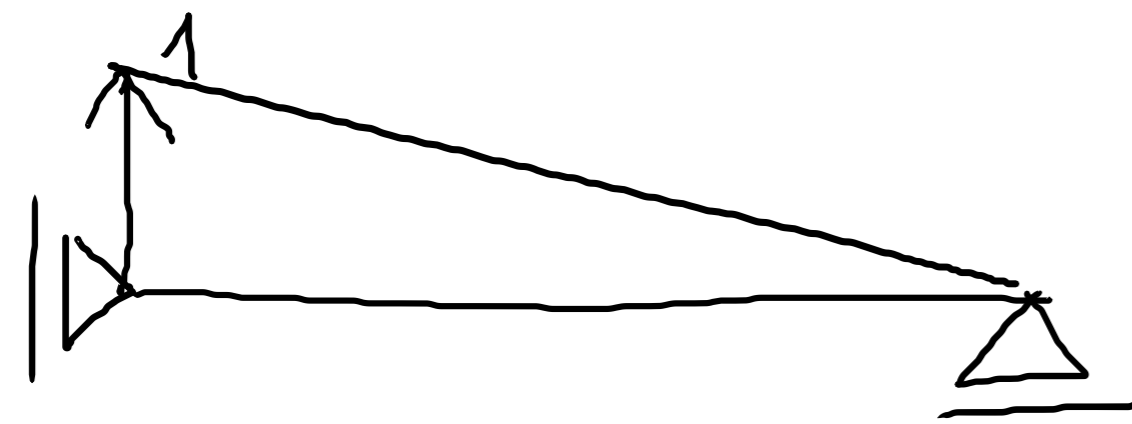

B



V_x

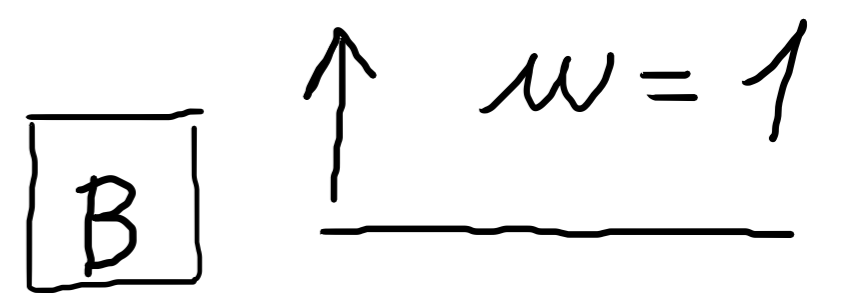
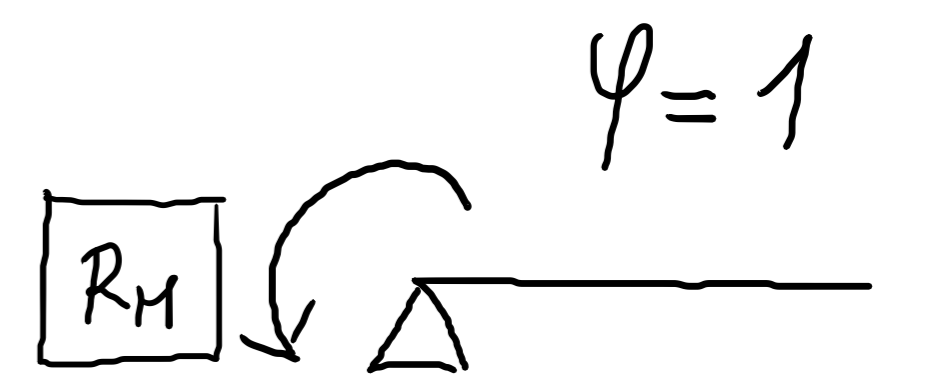
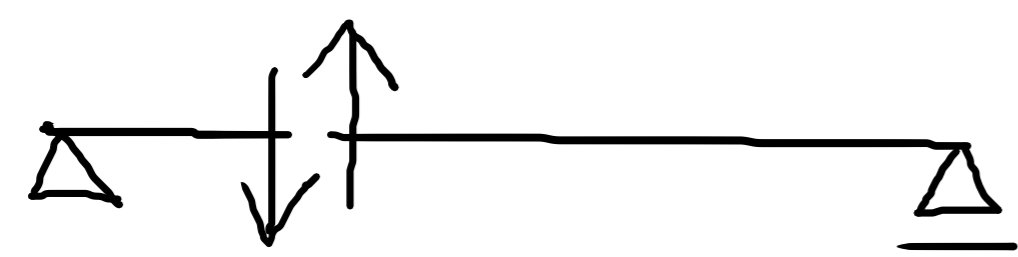

V_x

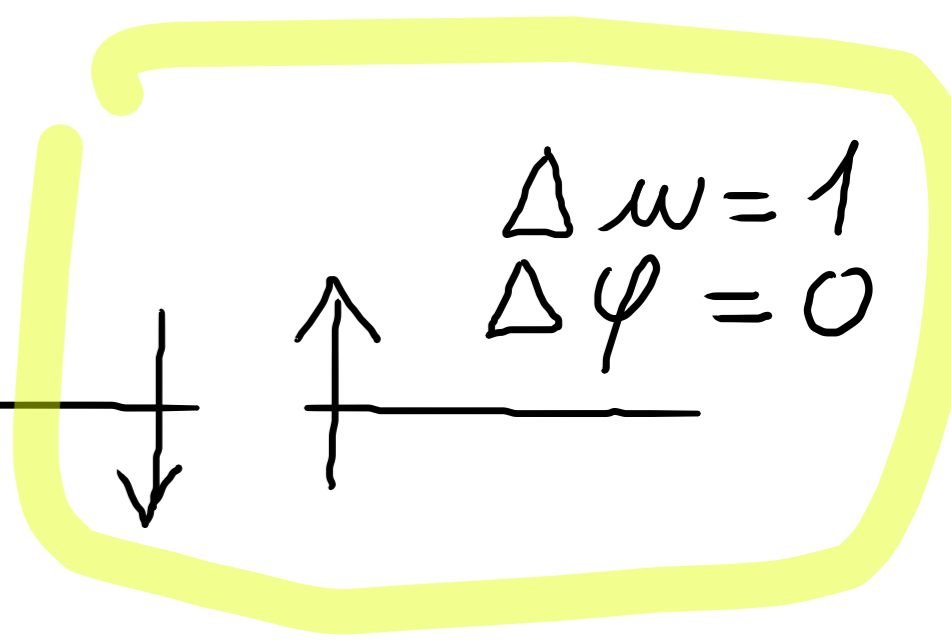

M_x

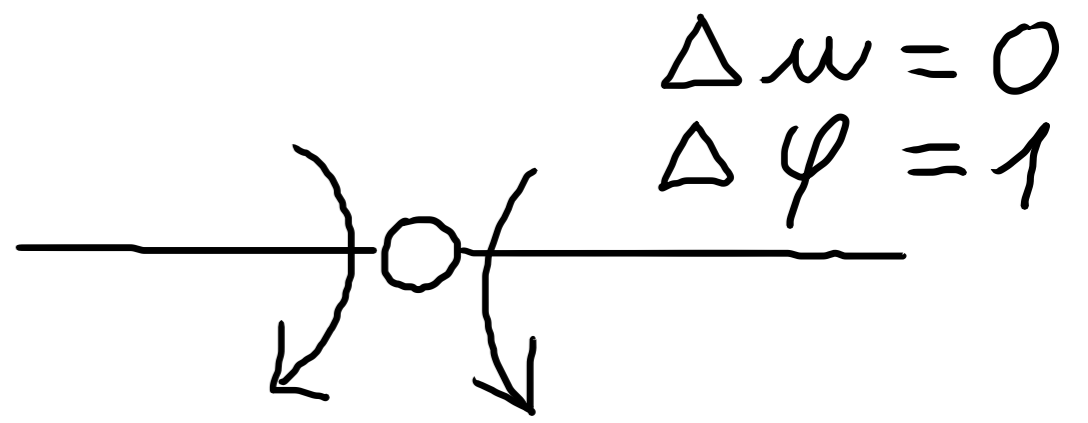

P.Č. - STATICKY URČITĚ KONSTRUKCE

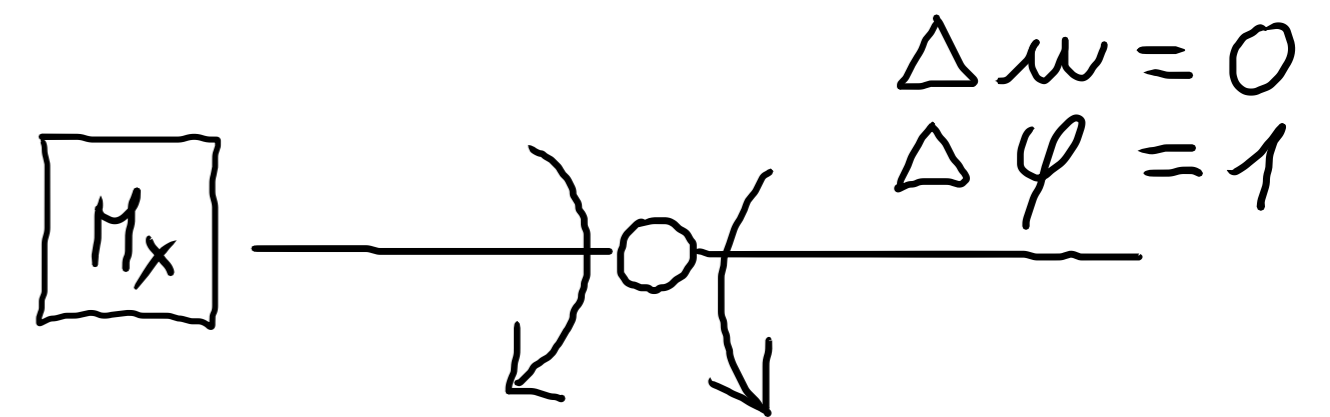
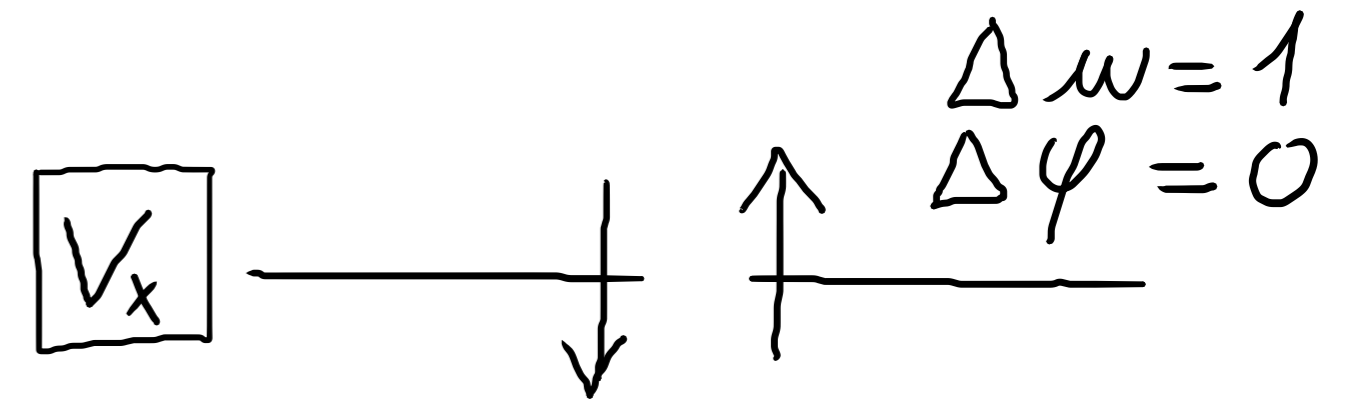
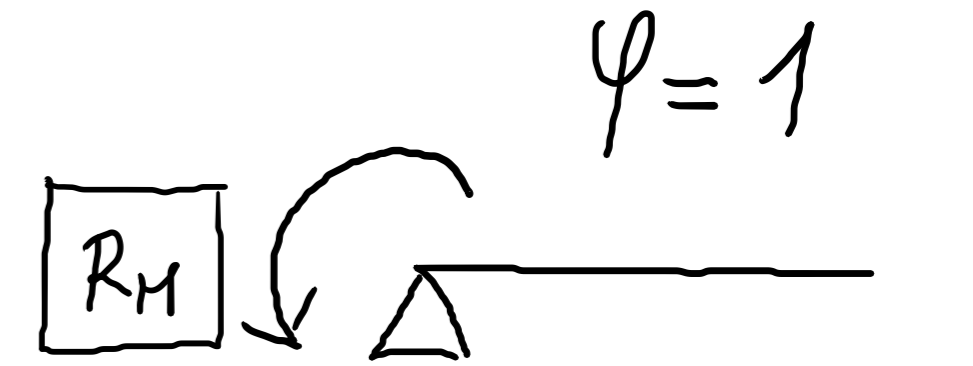
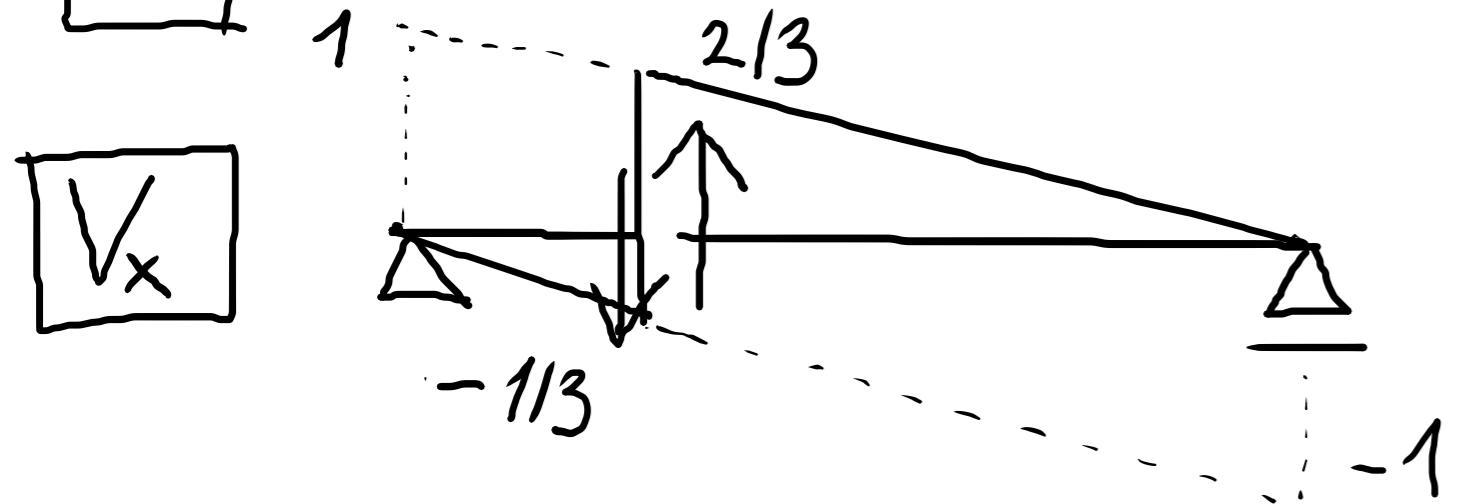
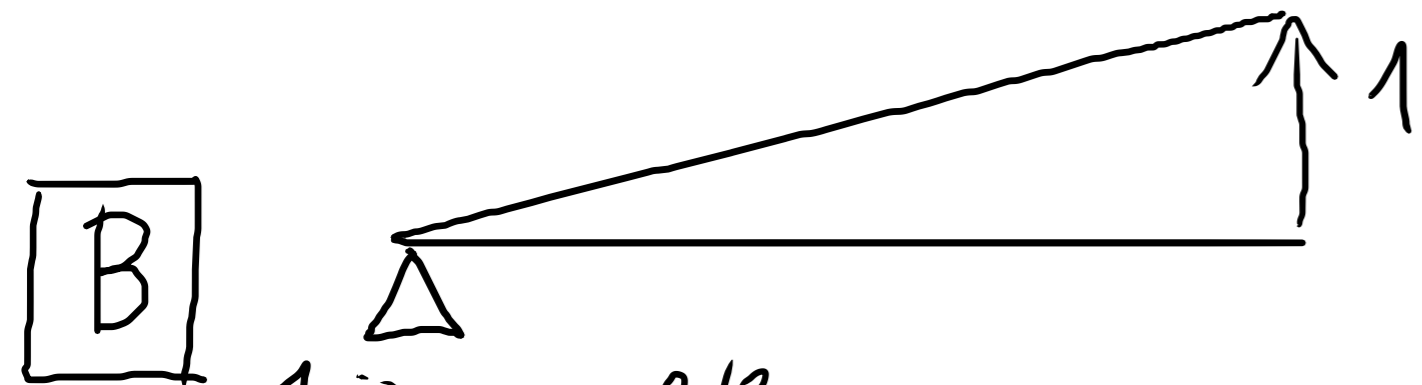
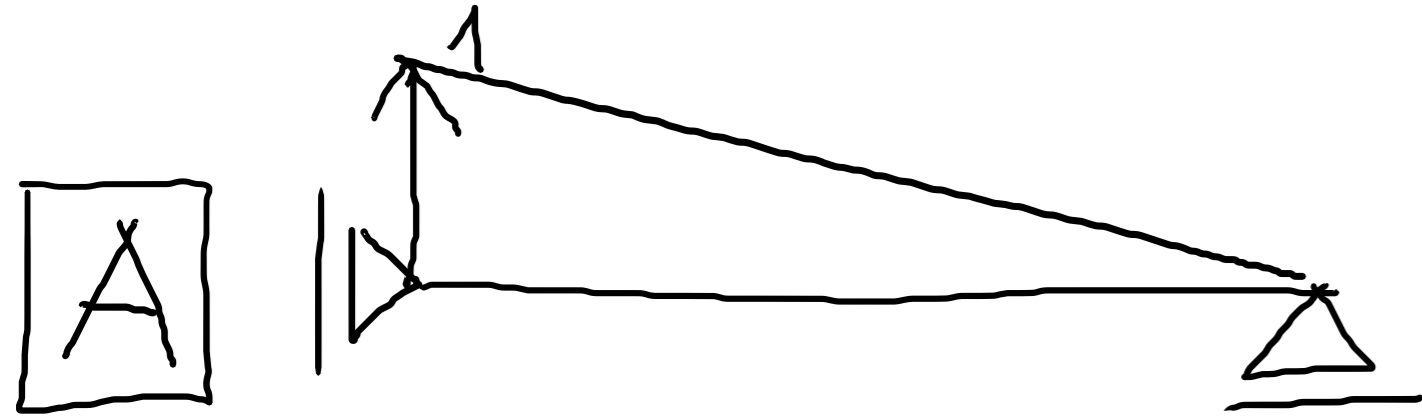
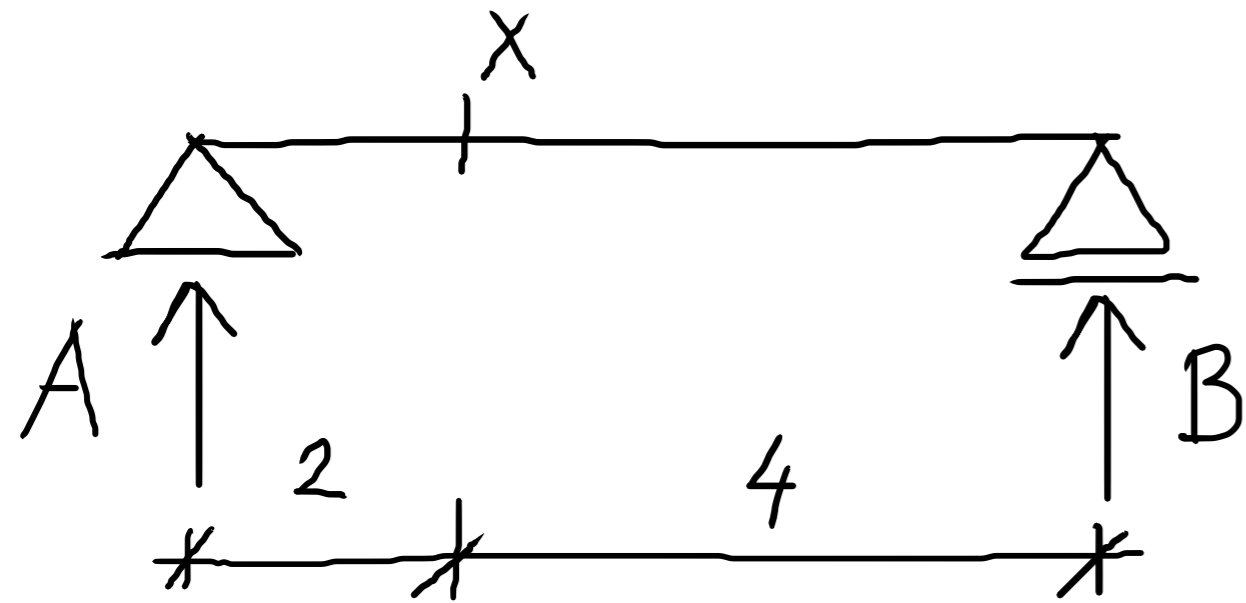

P.Č. - STATICKY URČITĚ KONSTRUKCE

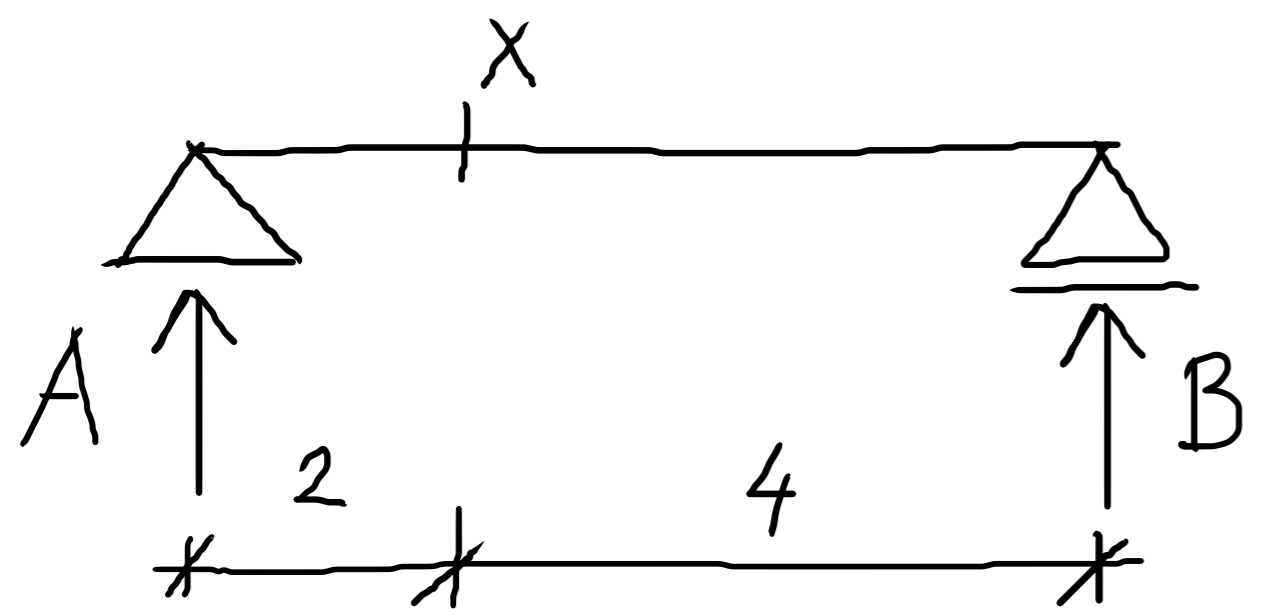

A

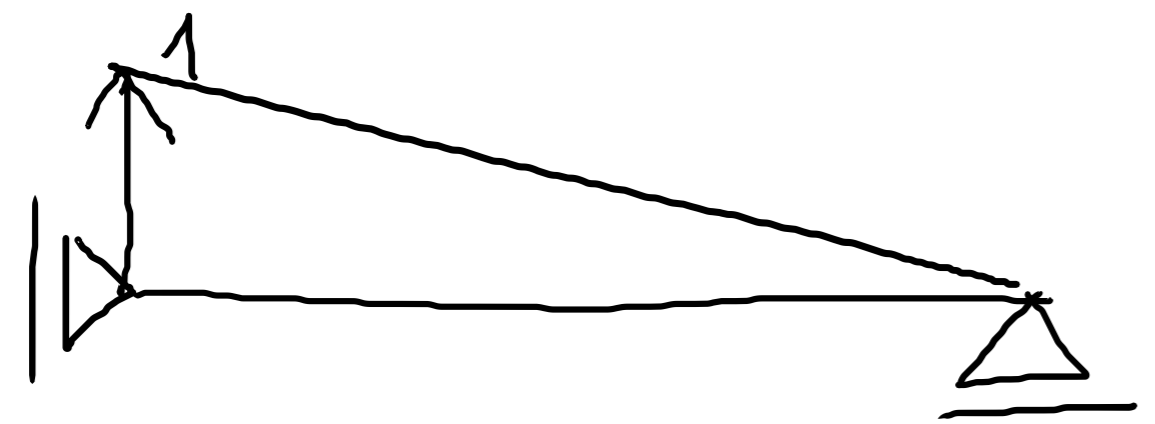

B



V_x

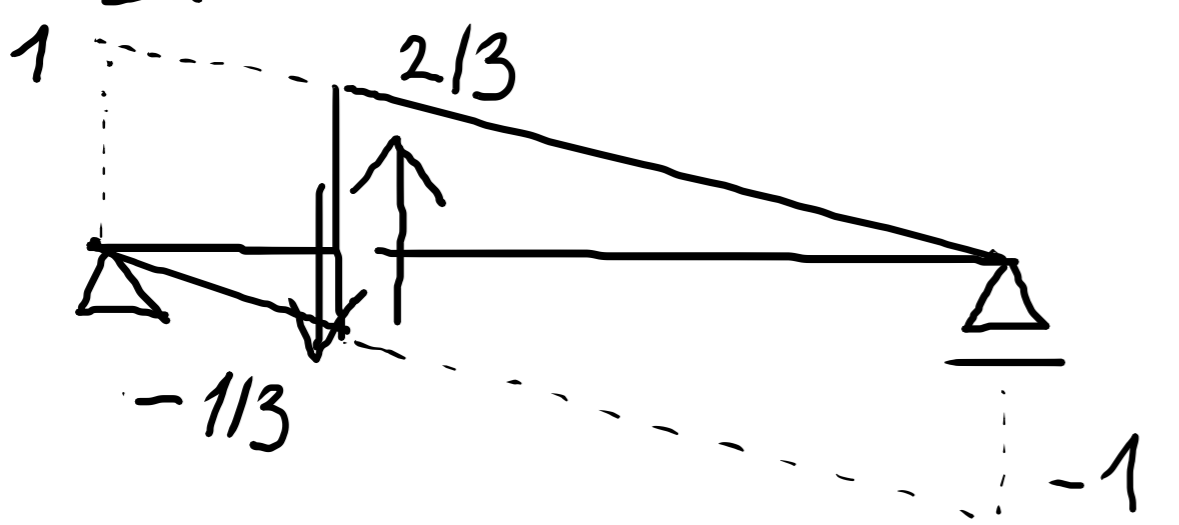

M_x

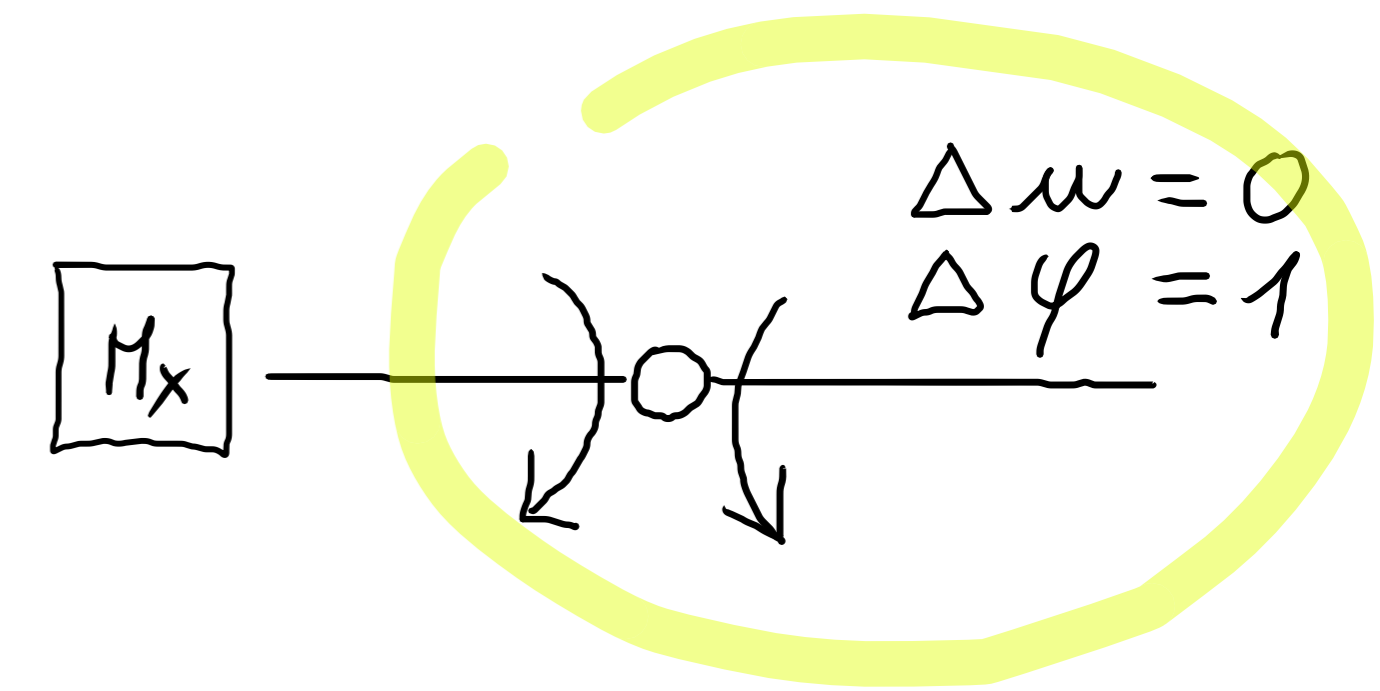
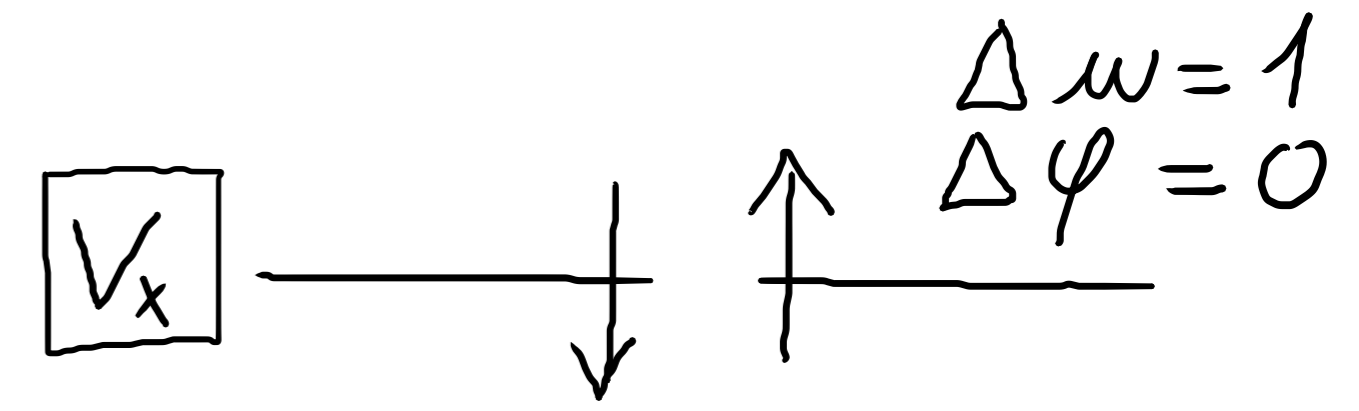
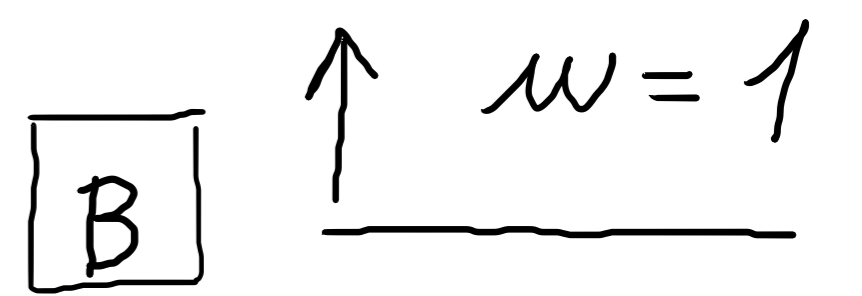
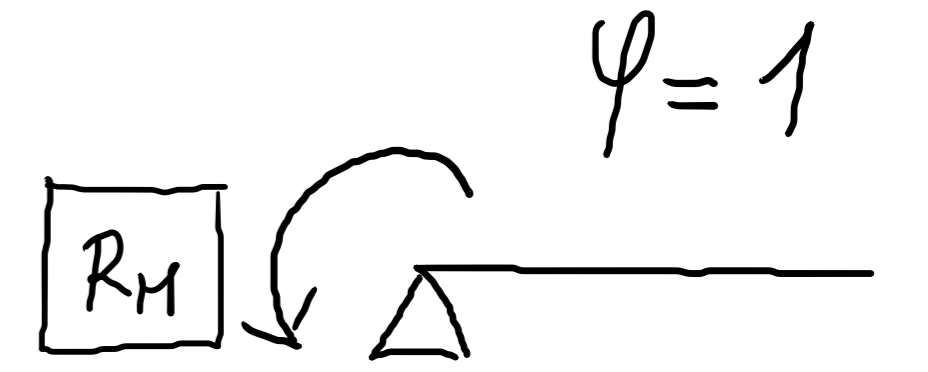
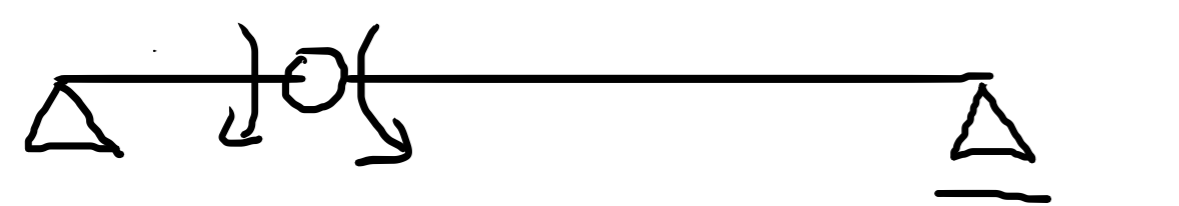

P.Č. - STATICKY URČITĚ KONSTRUKCE

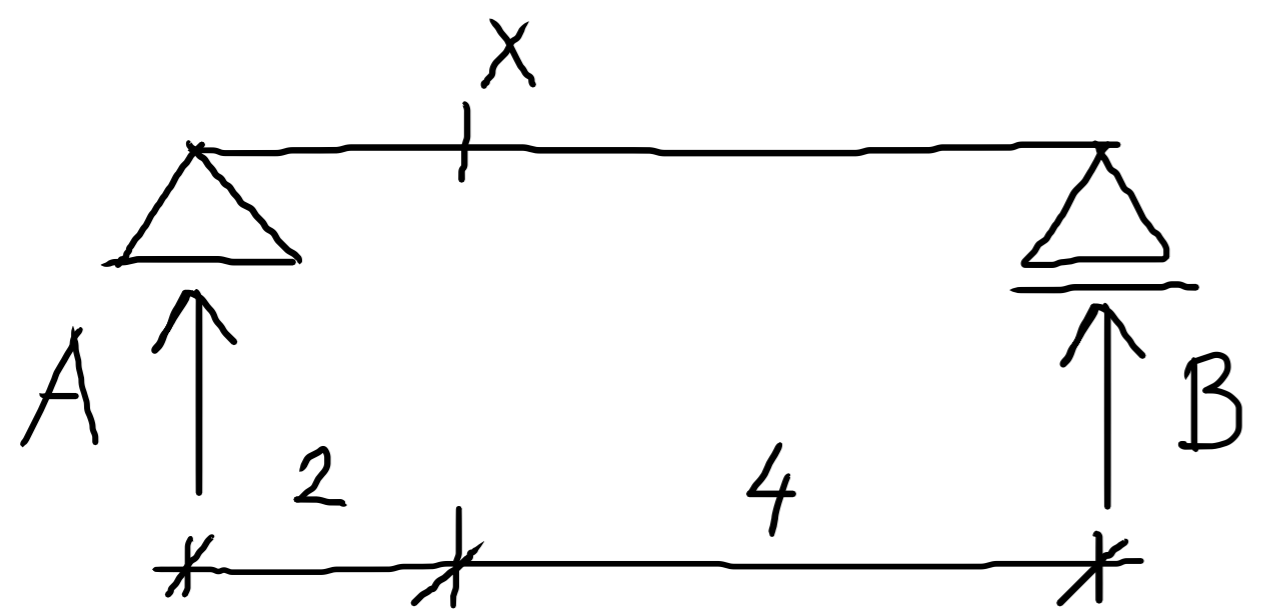

A

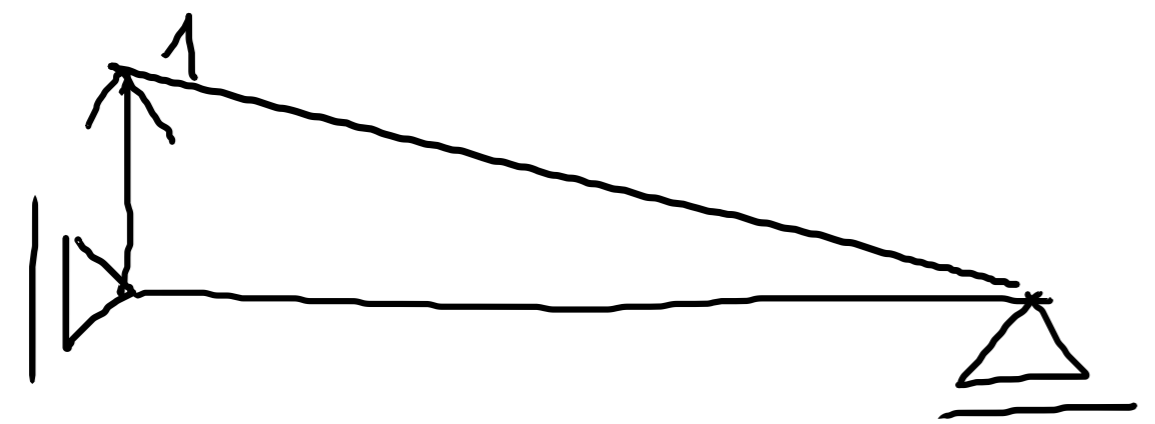

B



V_x

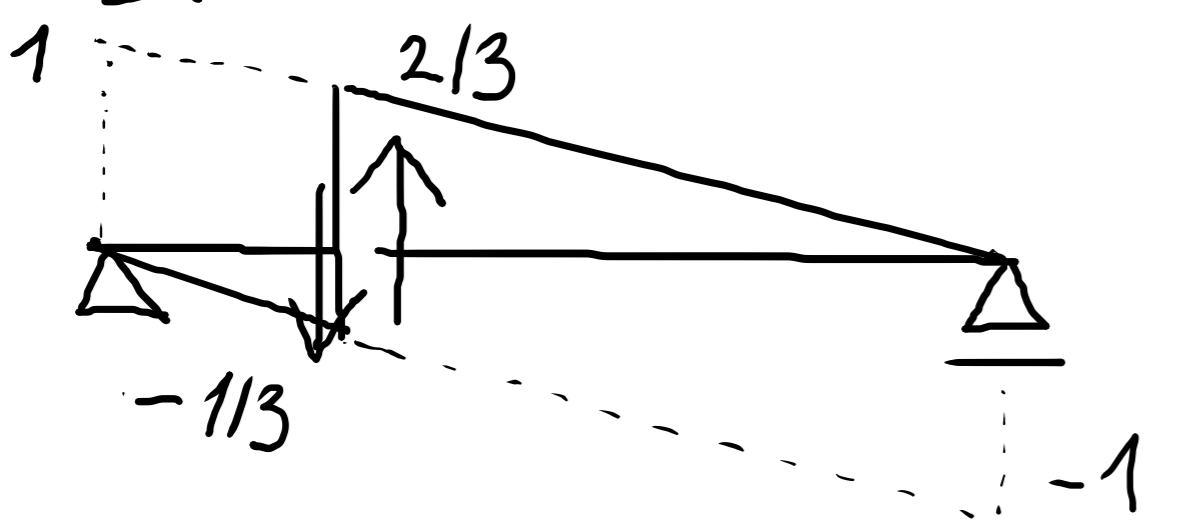

M_x

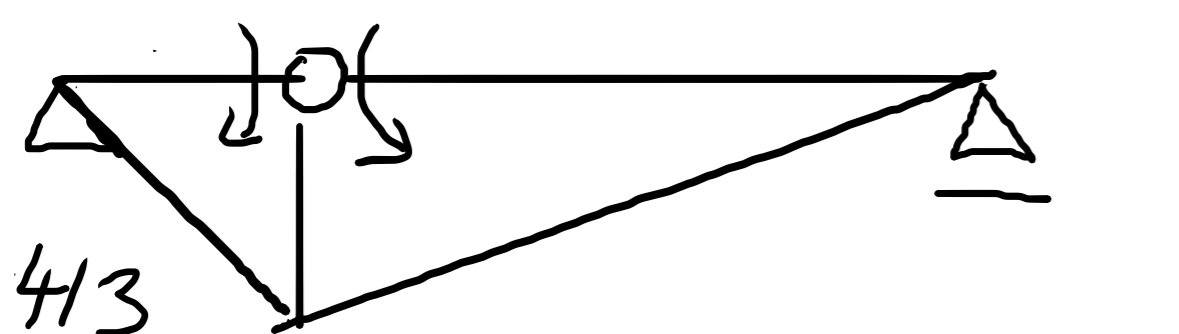

$$\frac{2 \cdot 4}{6} = \frac{8}{6} = \frac{4}{3}$$

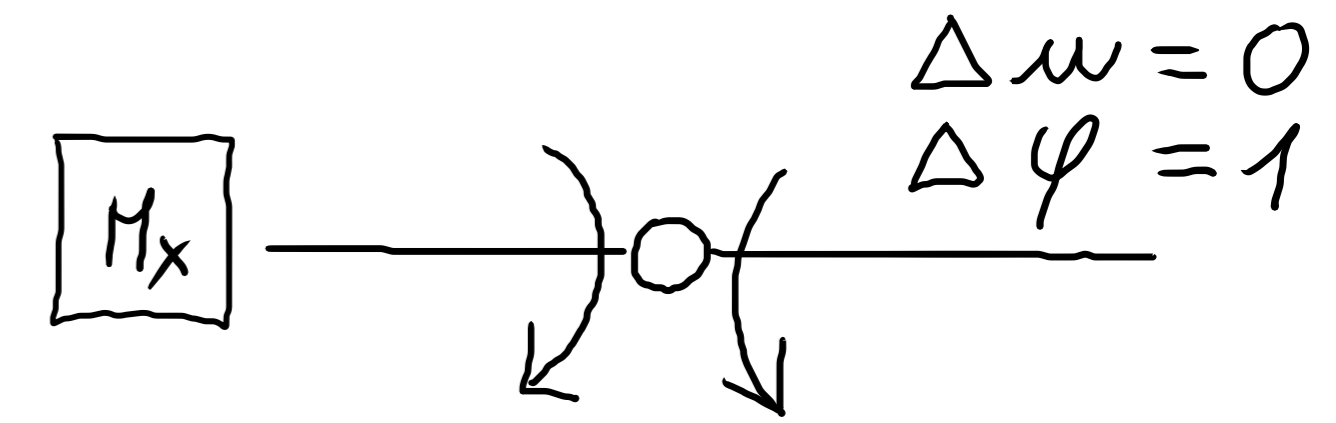
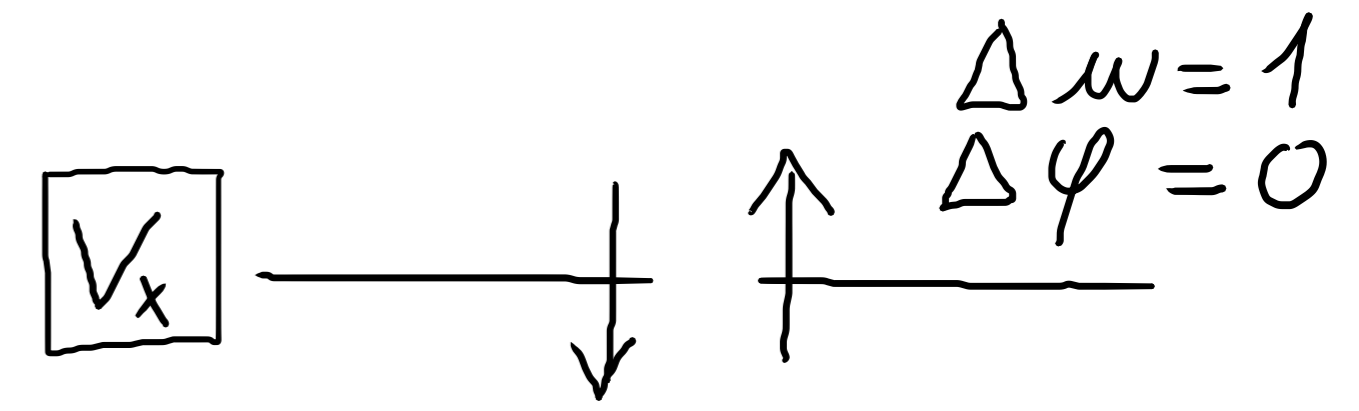
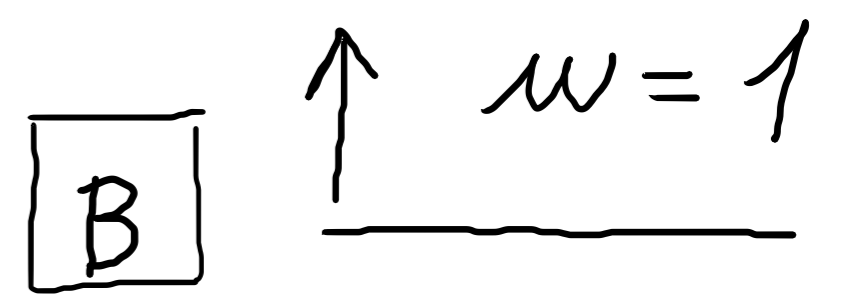
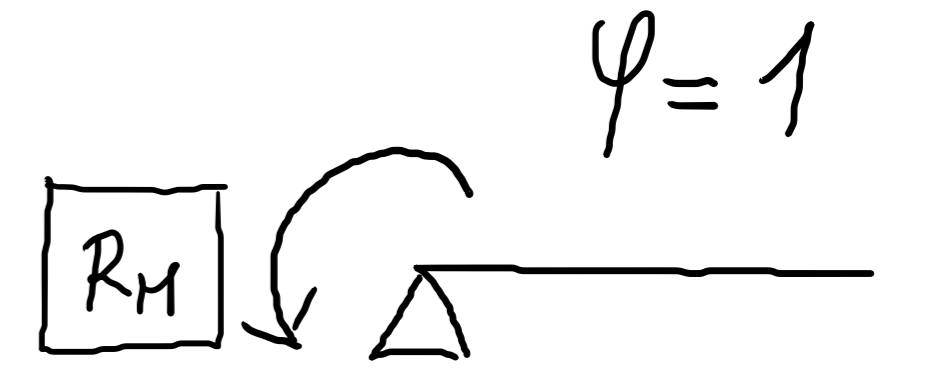

P.Č. - STATICKY URČITĚ KONSTRUKCE

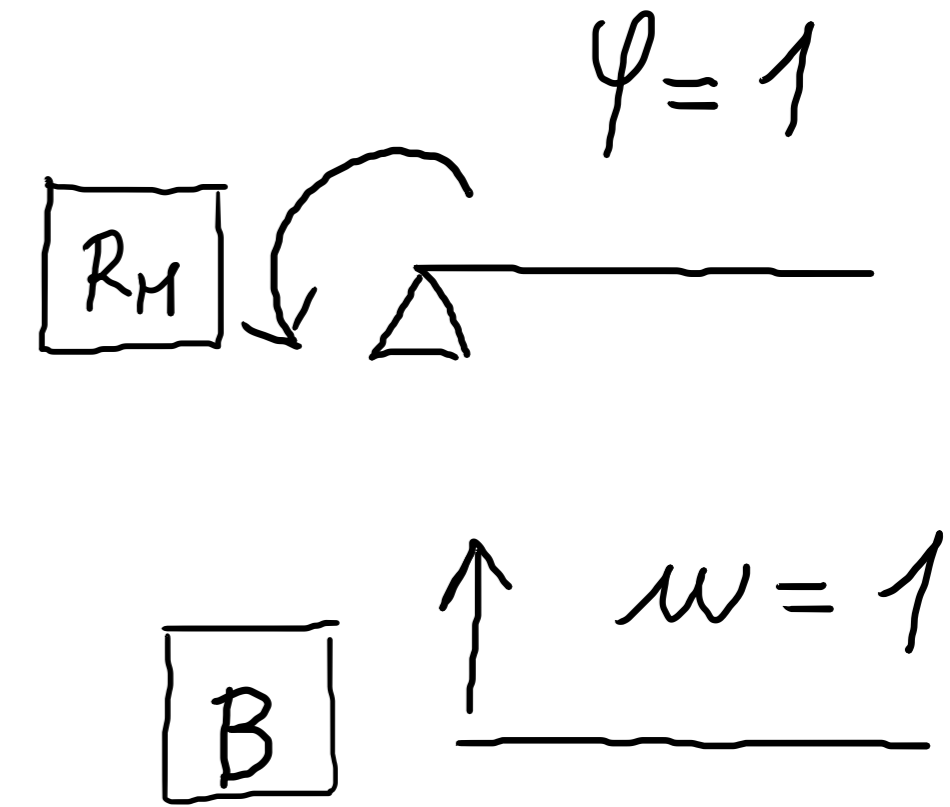
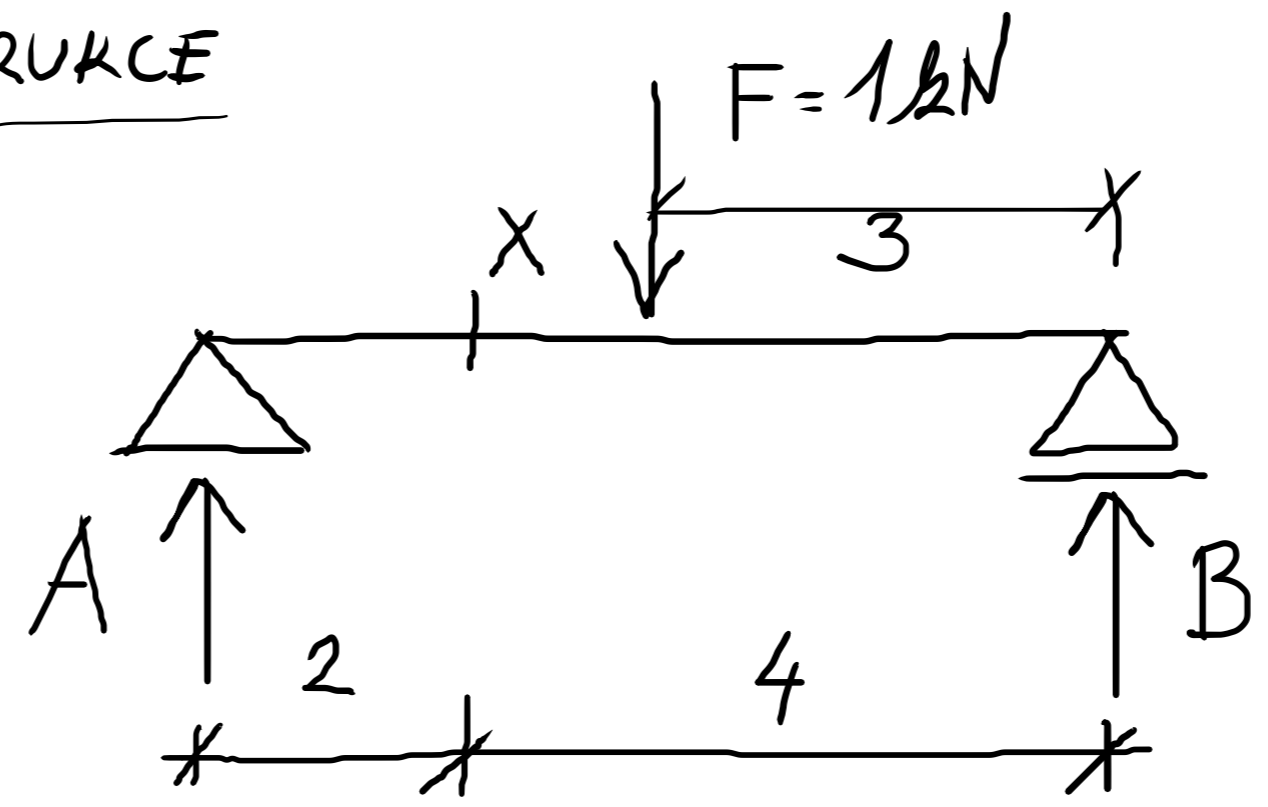
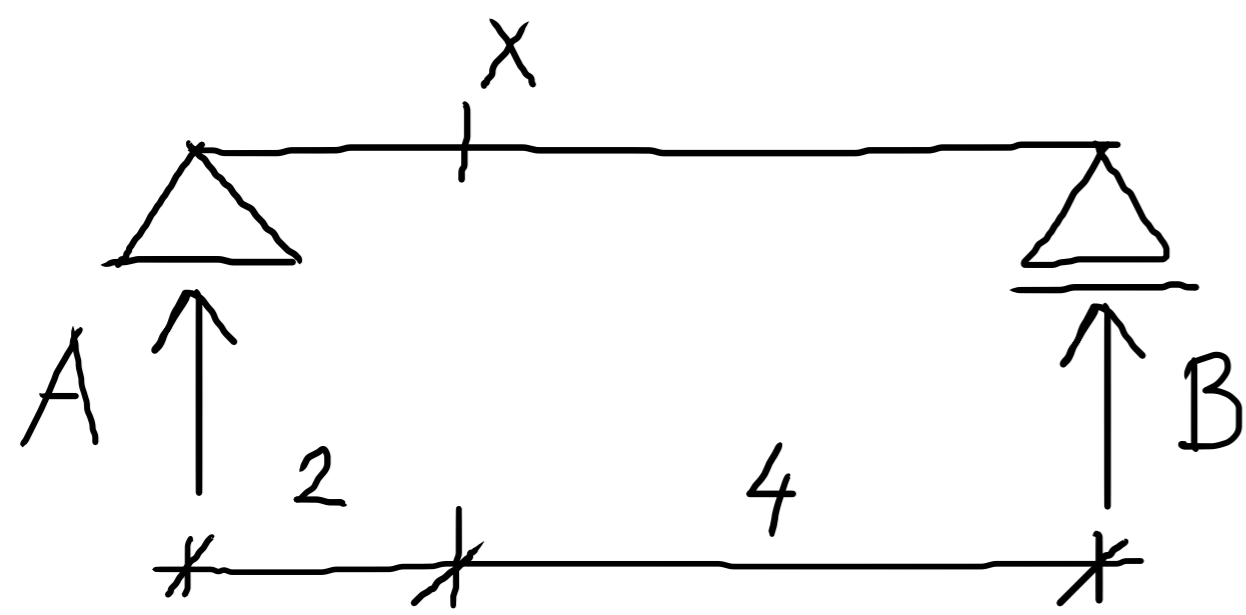

A

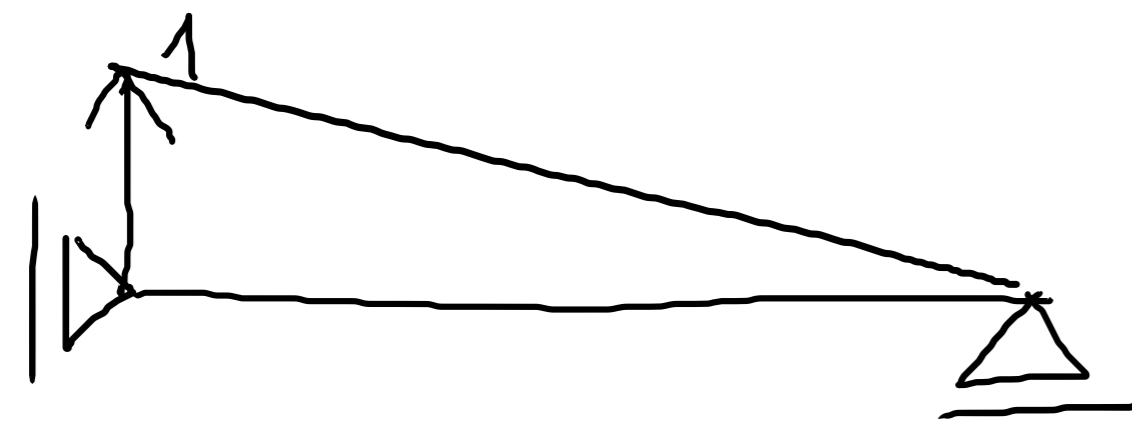

B



V_x

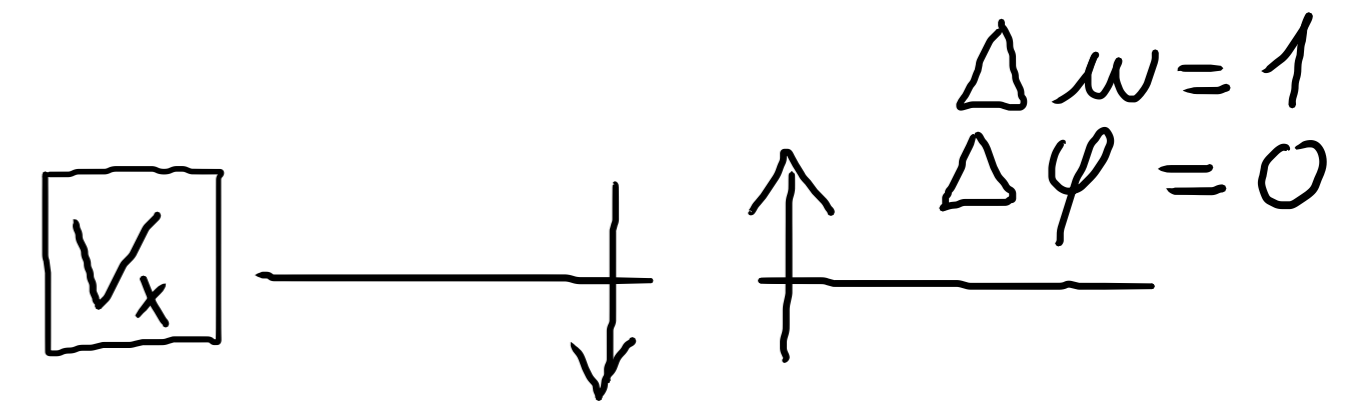
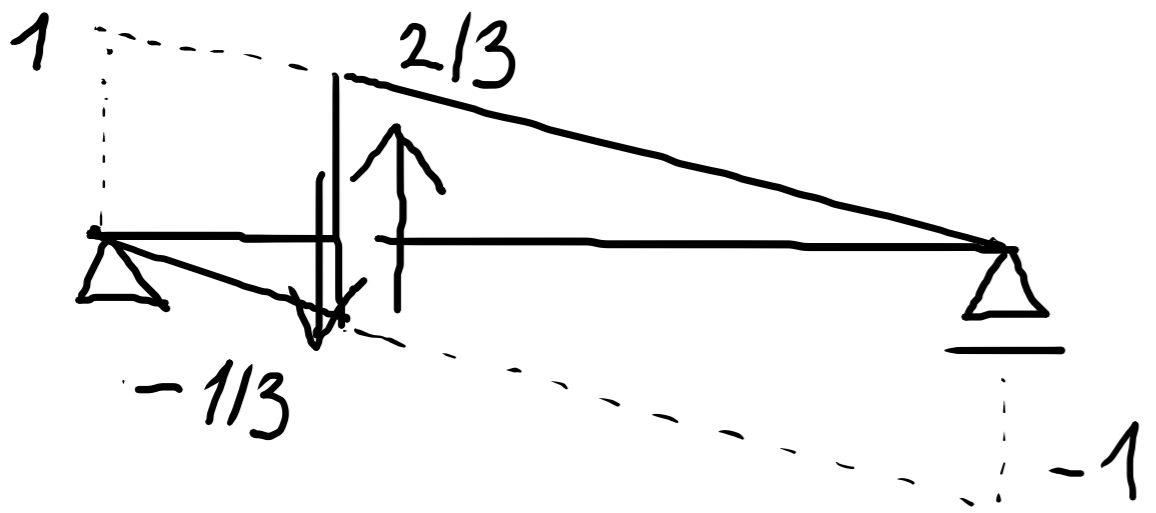

M_x

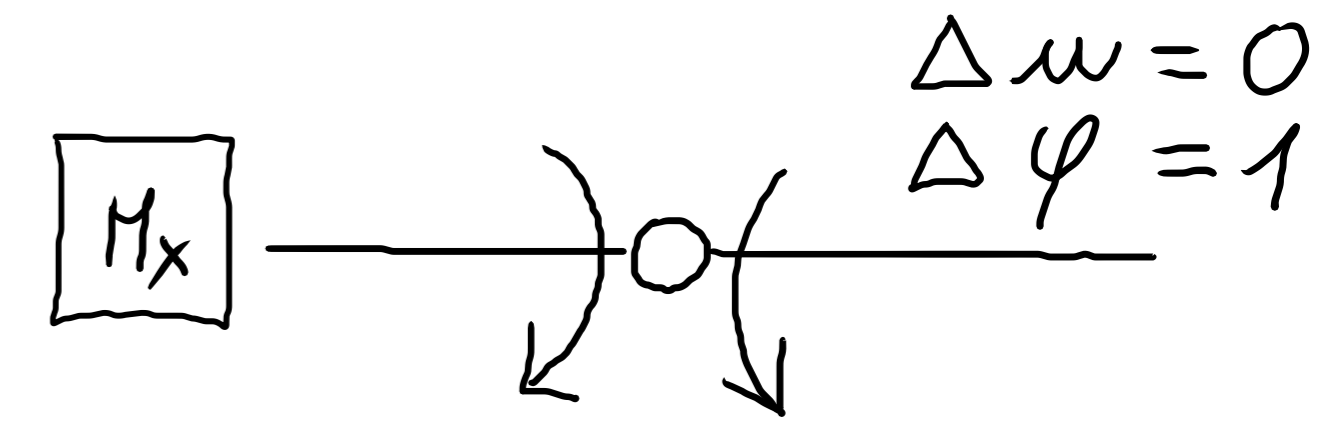
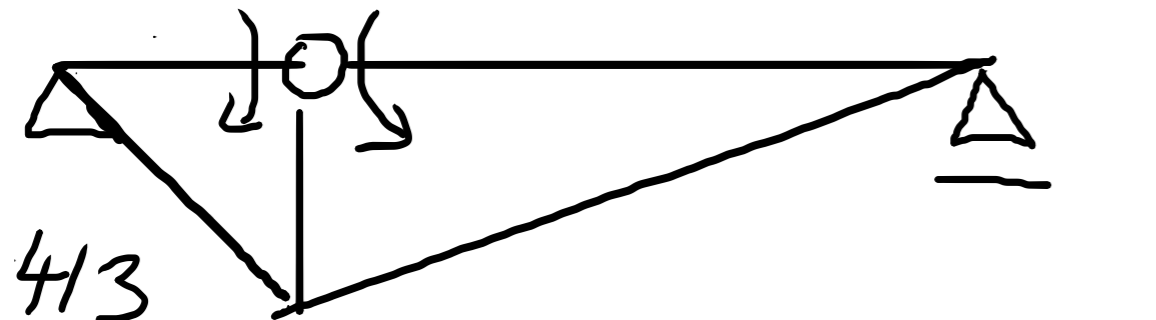

$$\frac{2 \cdot 4}{6} = \frac{8}{6} = \frac{4}{3}$$

P.Č. - STATICKY URČITĚ KONSTRUKCE

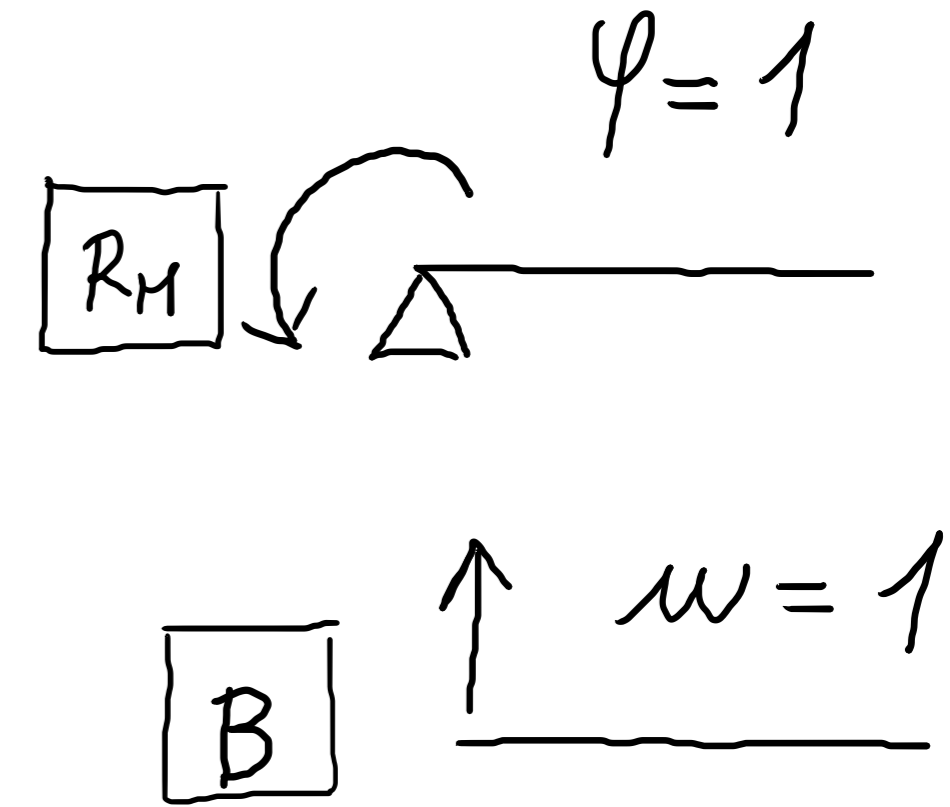
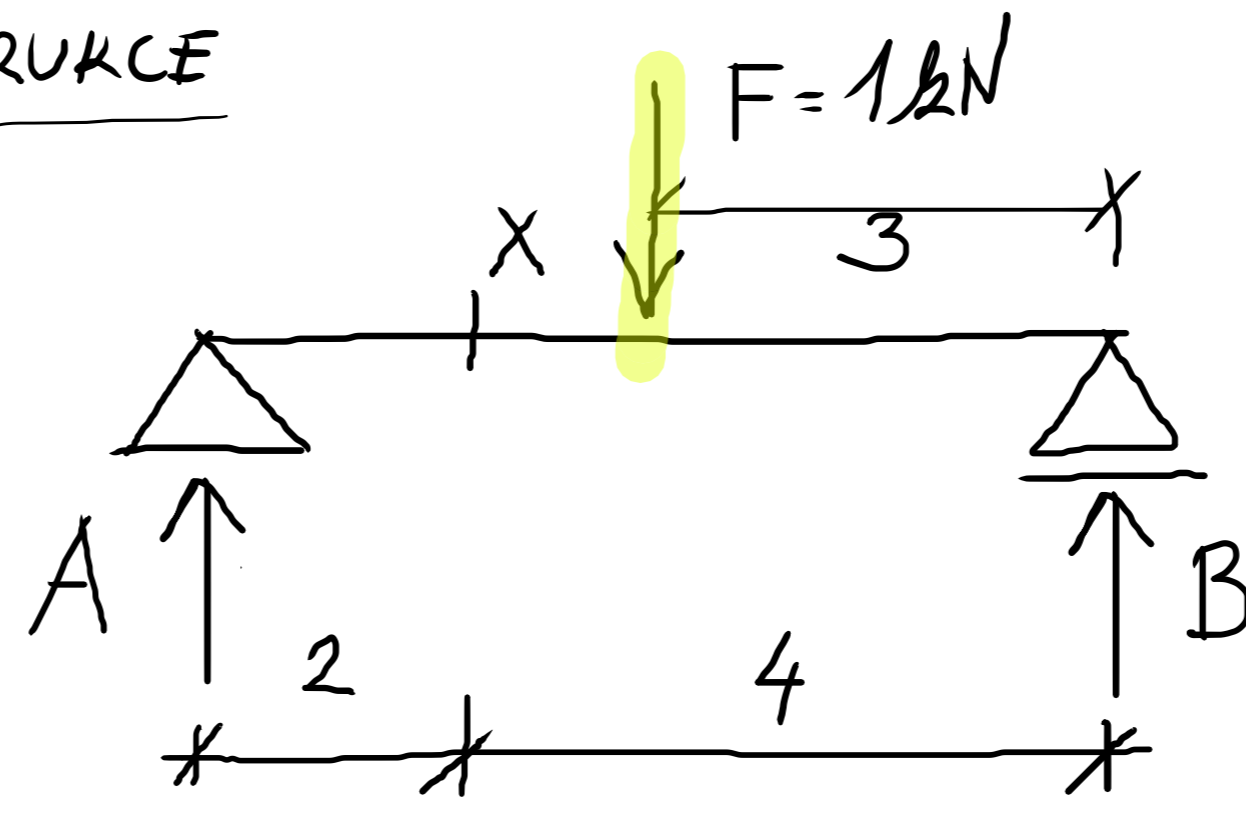
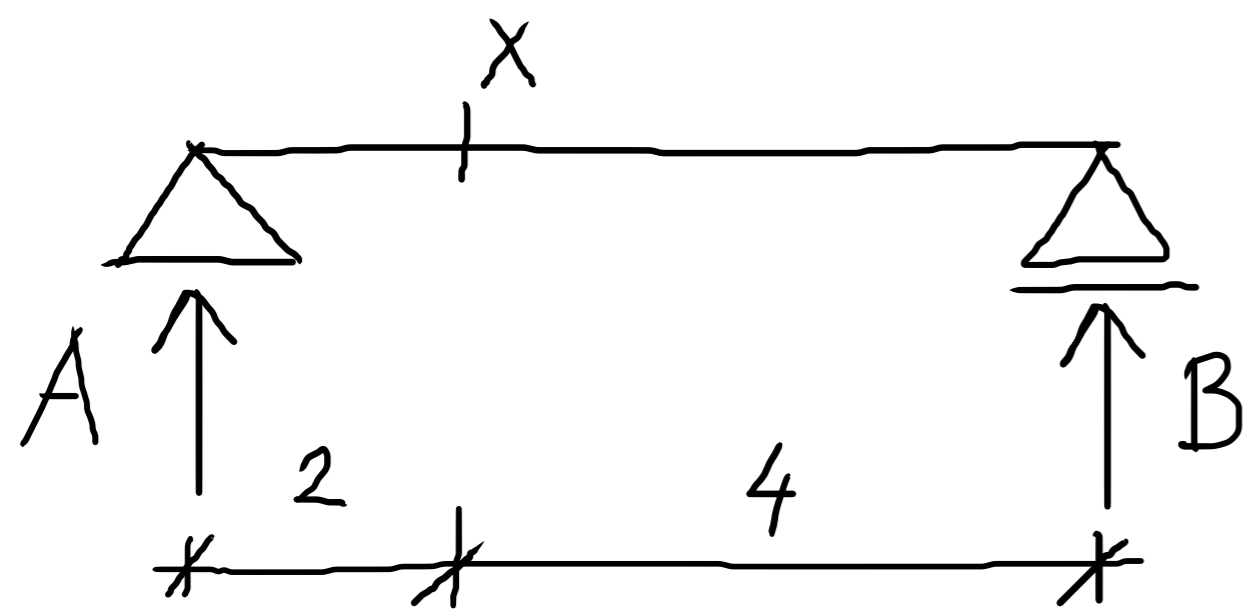

A

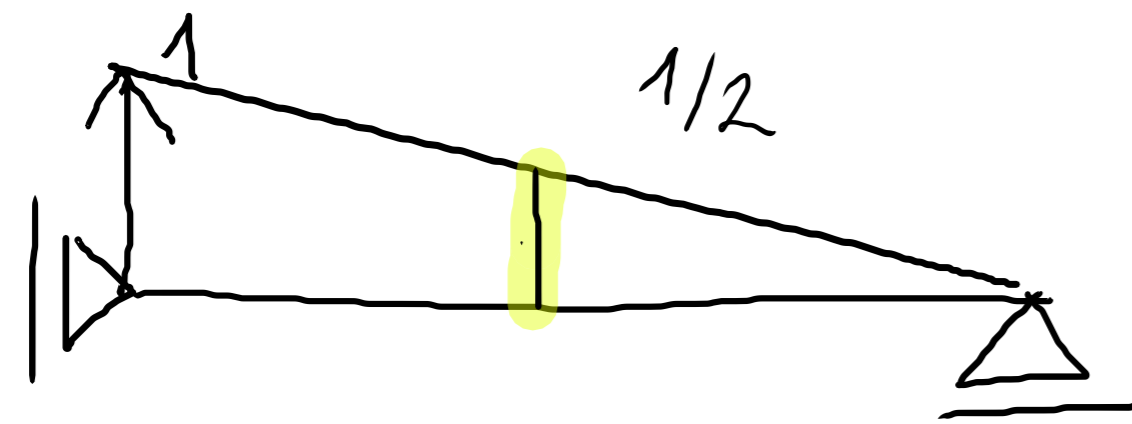

$$A = \frac{1}{2} \text{ kN}$$

B

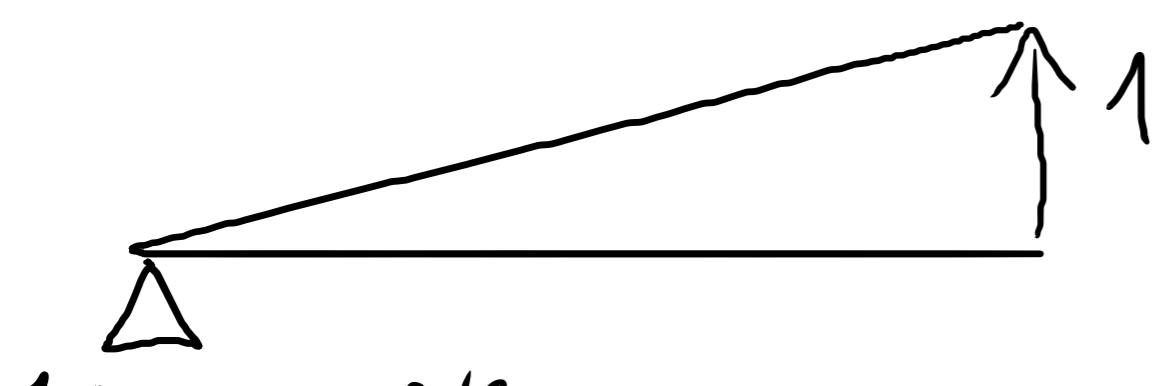

V_x

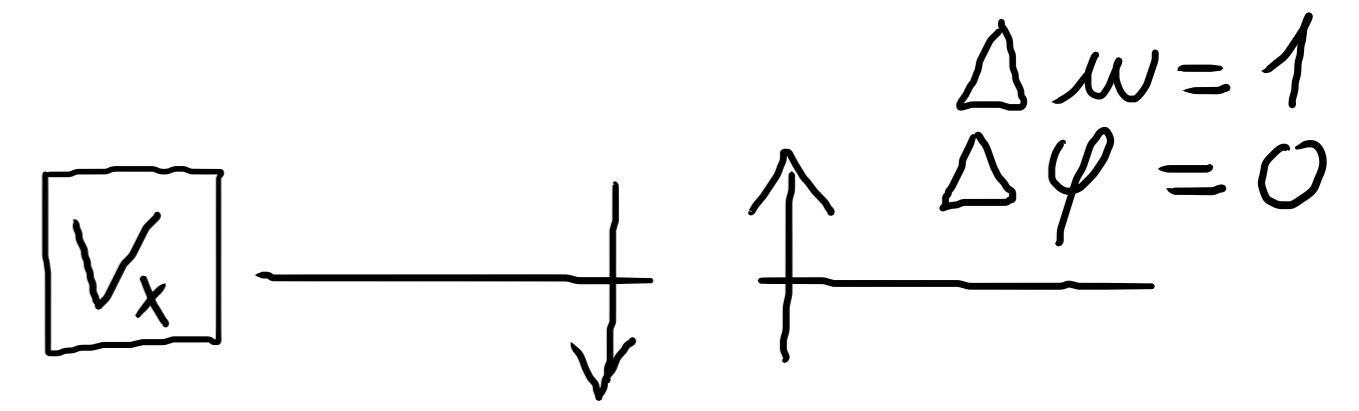
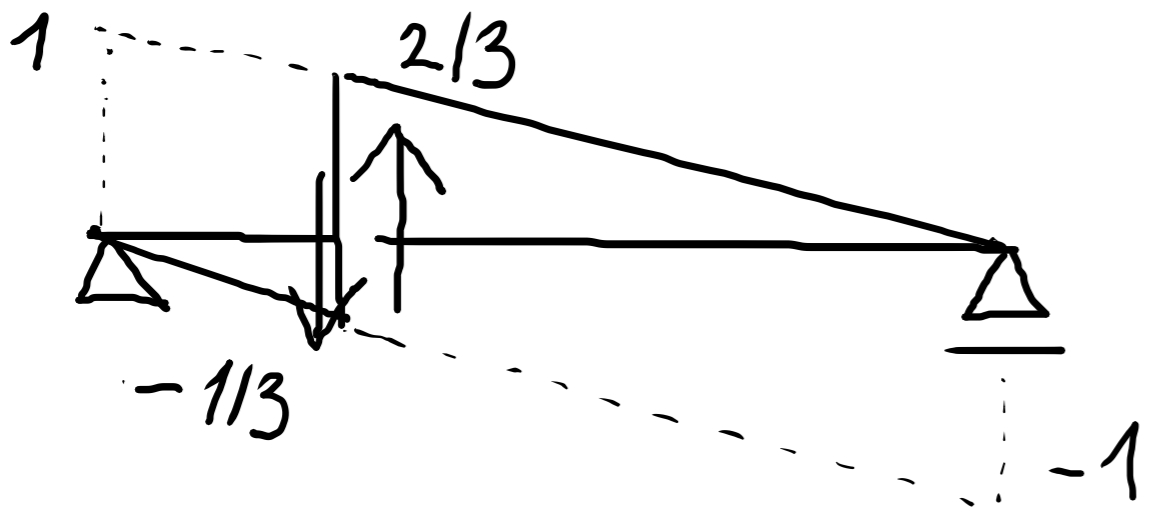

M_x

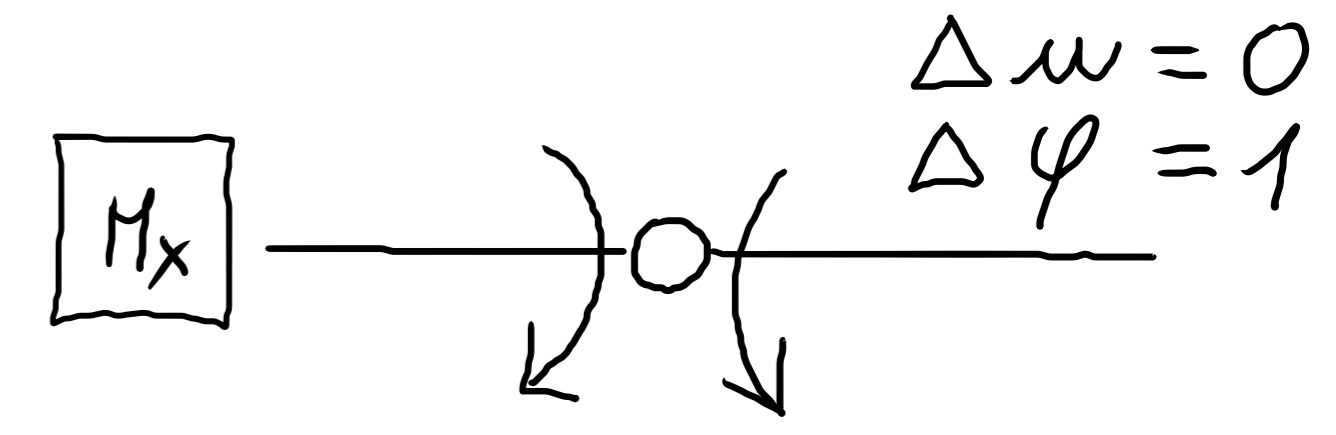
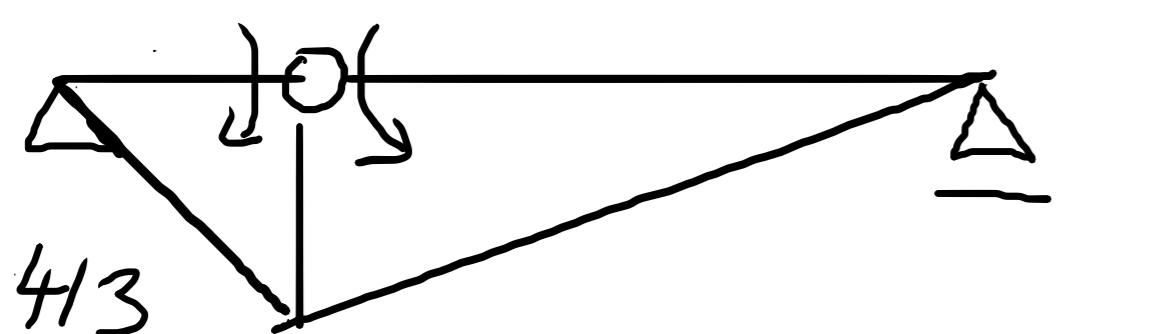

$$\frac{2 \cdot 4}{6} = \frac{8}{6} = \frac{4}{3}$$

P.Č. - STATICKY URČITĚ KONSTRUKCE

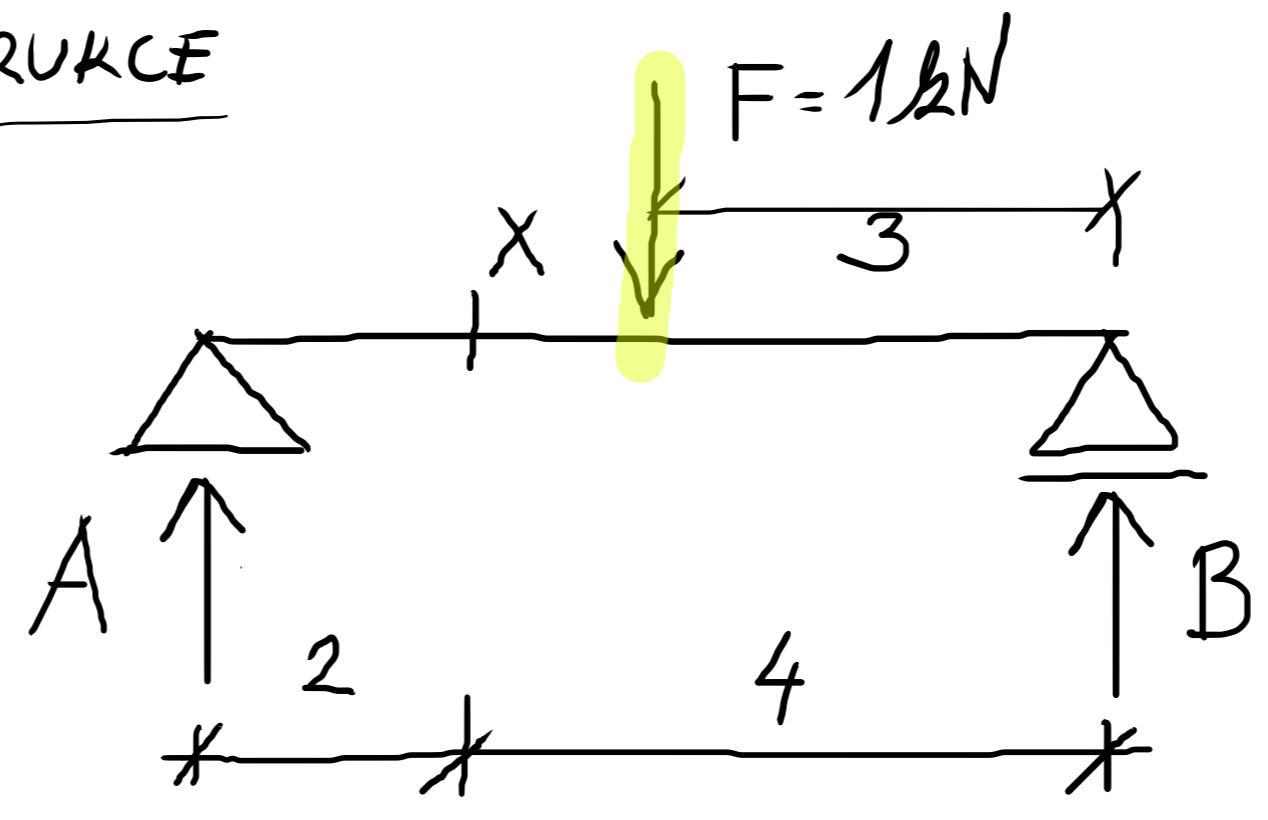
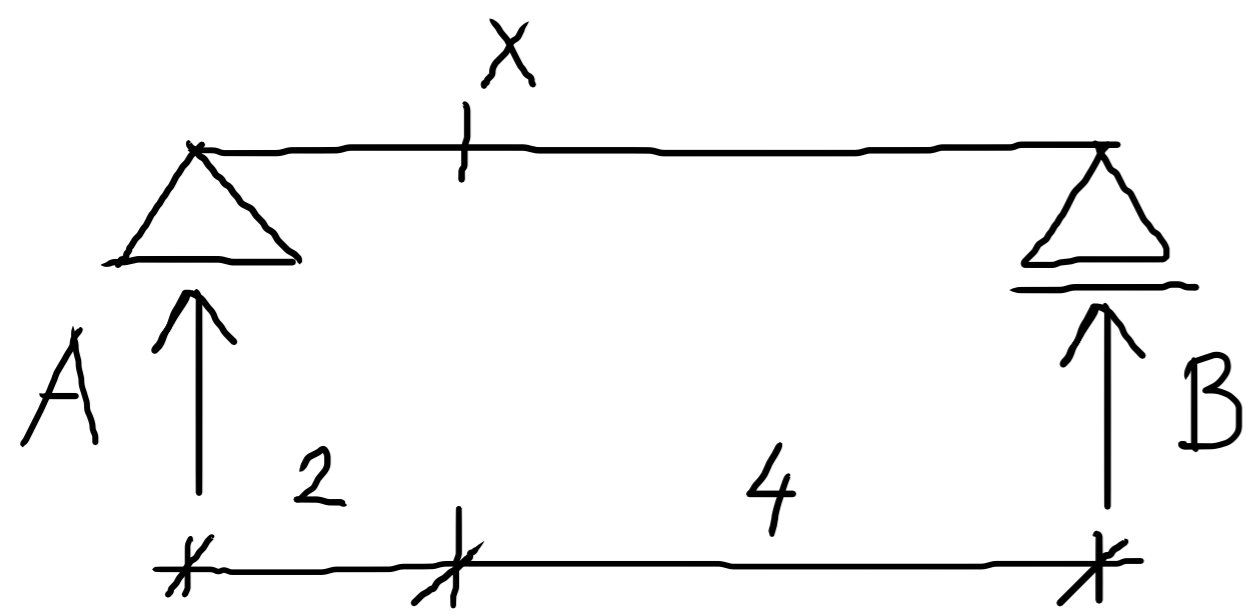

A

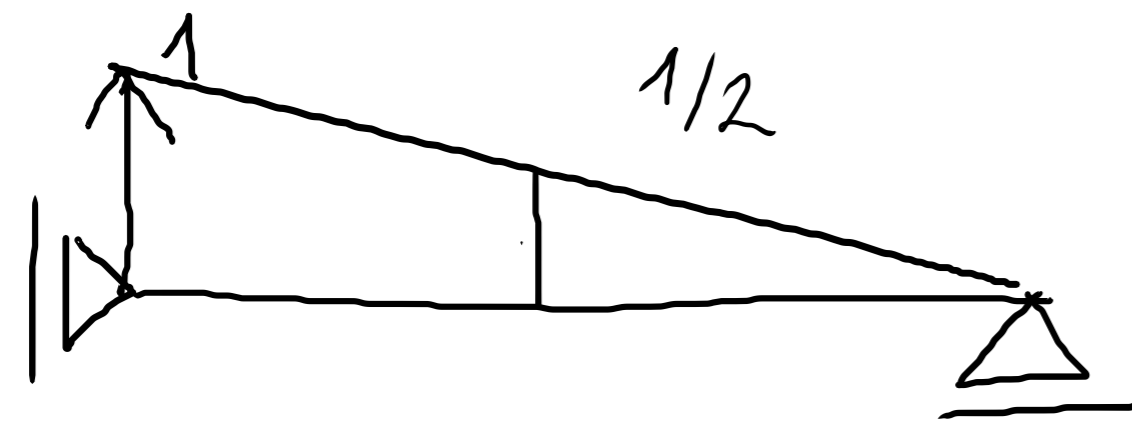

$A = \frac{1}{2} \text{ kN}$

$B = \frac{1}{2} \text{ kN}$

B

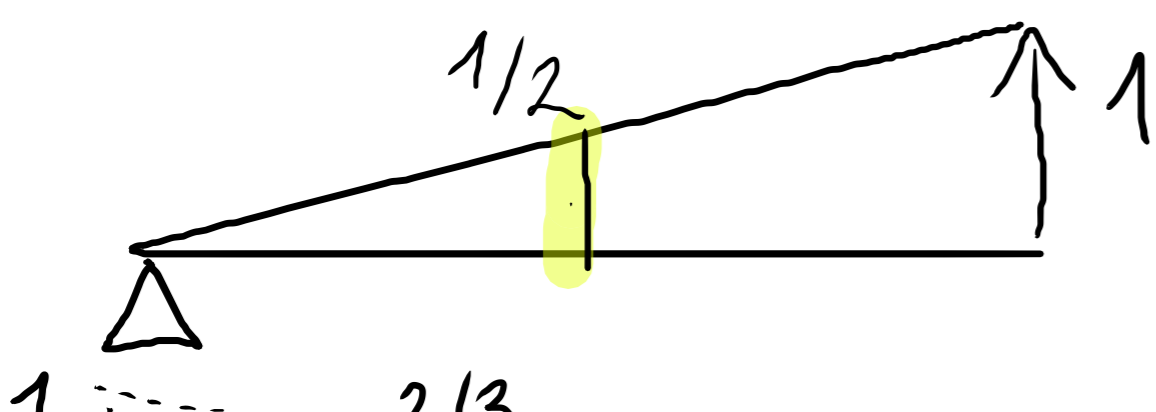

V_x

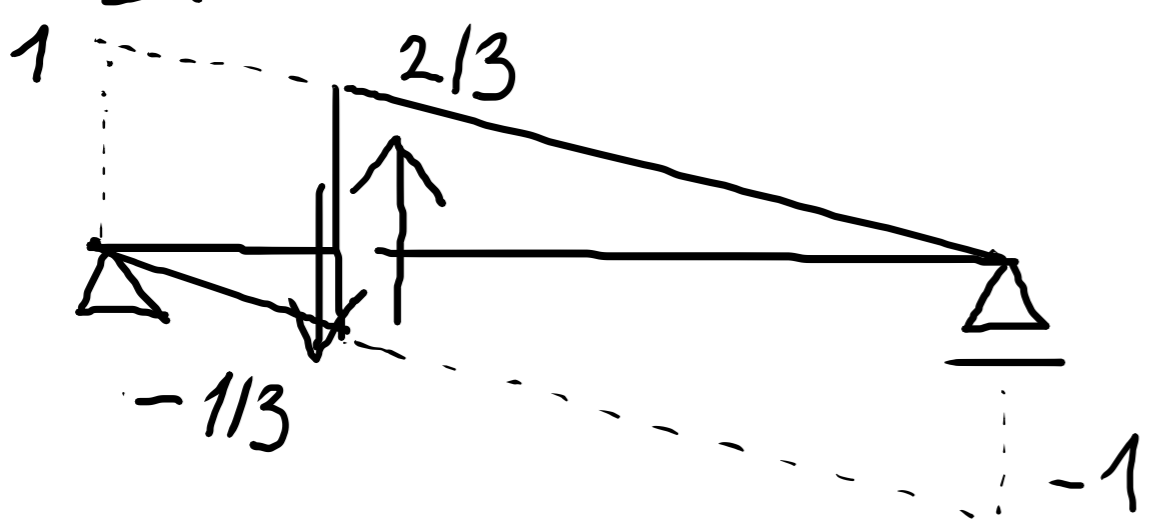

M_x

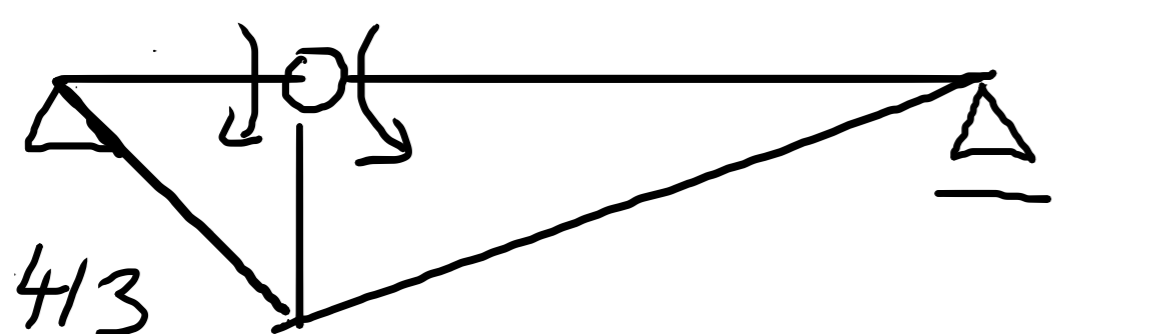

$\frac{2 \cdot 4}{6} = \frac{8}{6} = \frac{4}{3}$

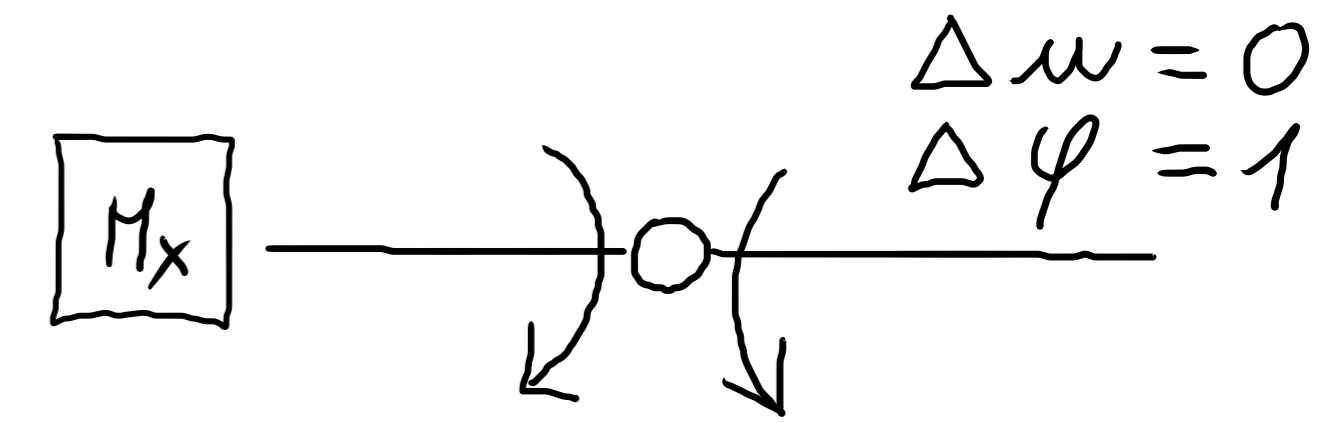
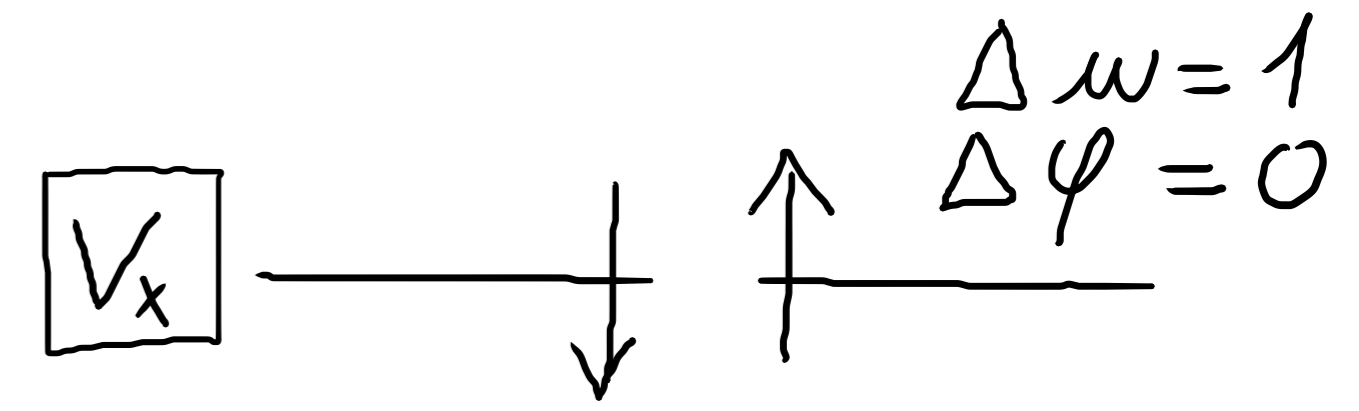
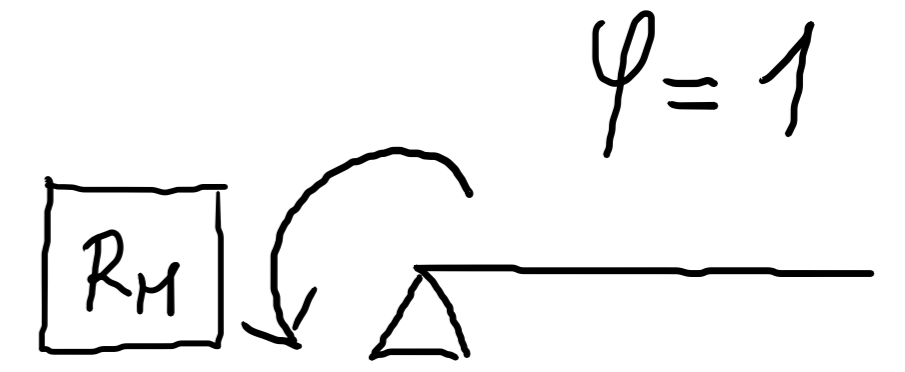

P.Č. - STATICKY URČITĚ KONSTRUKCE

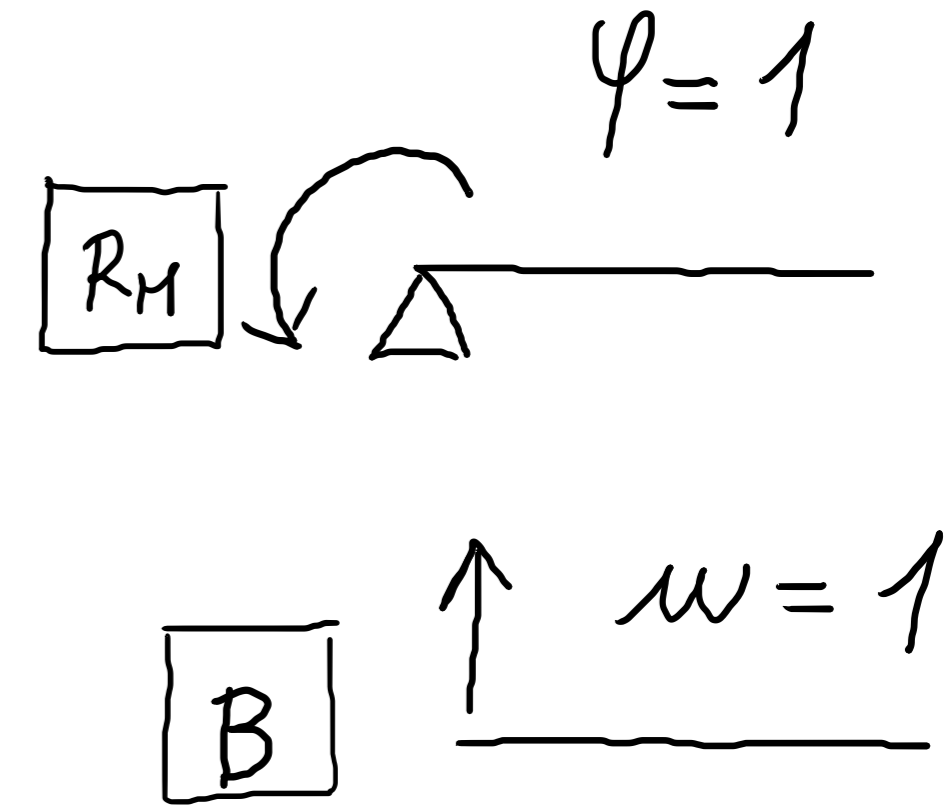
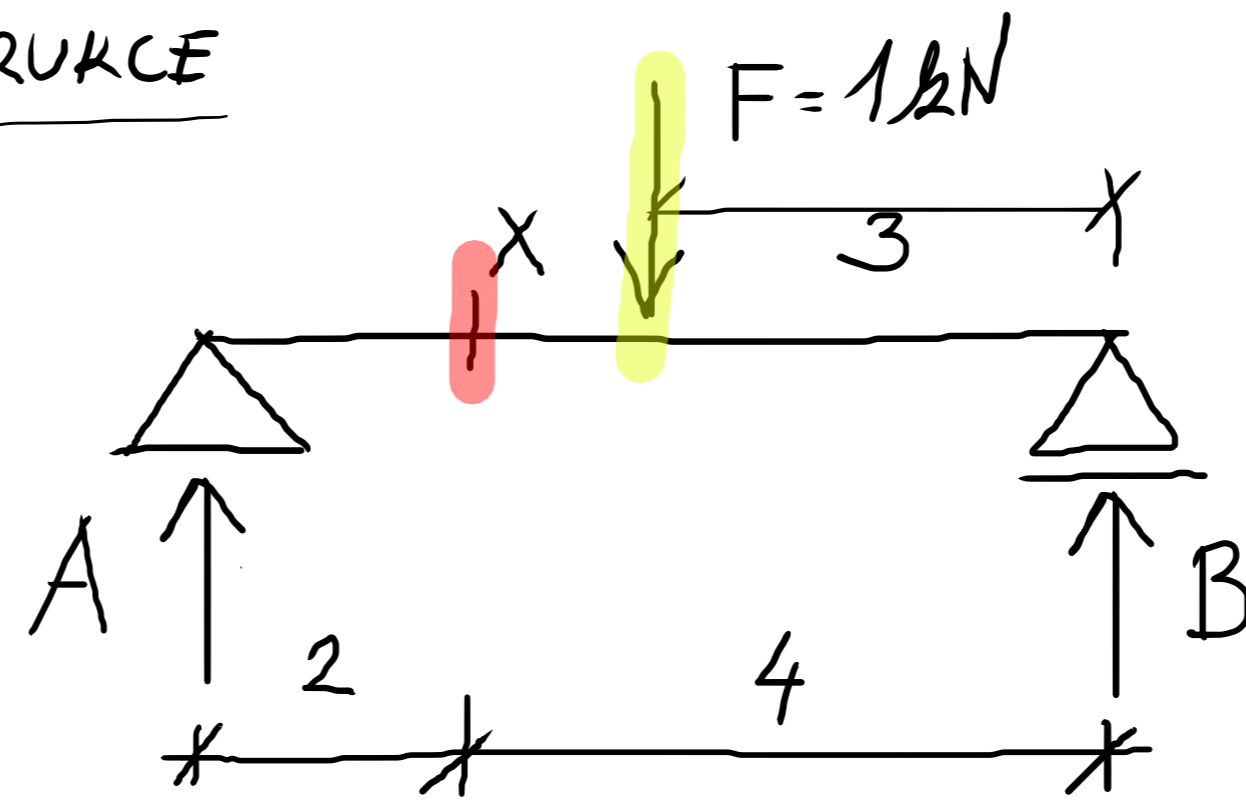
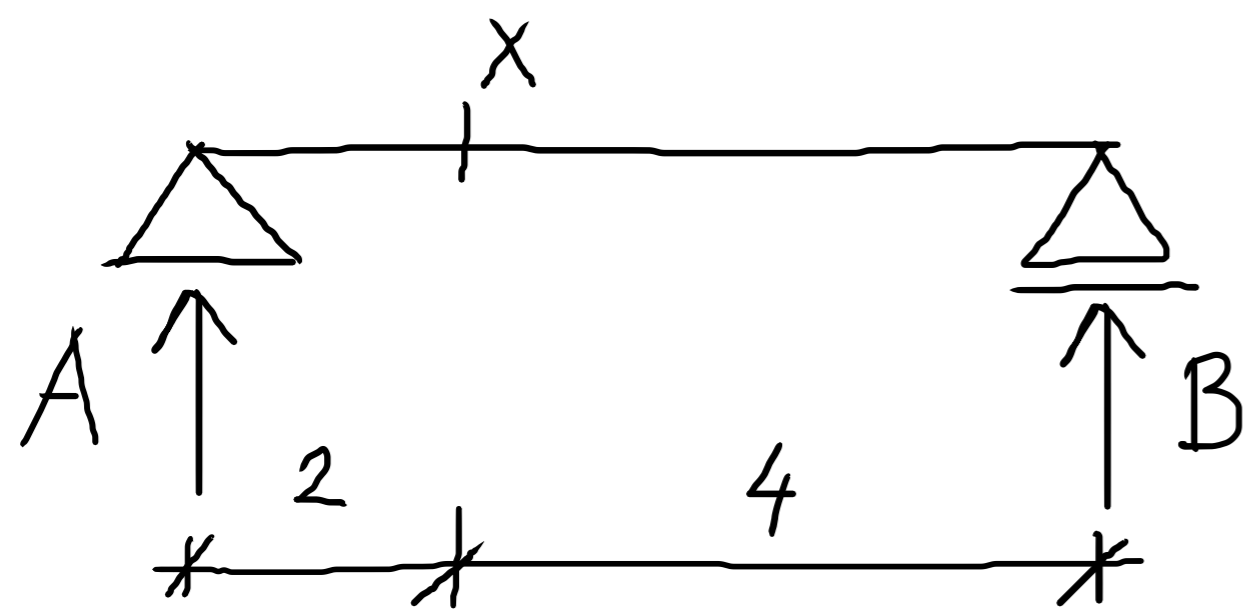

A

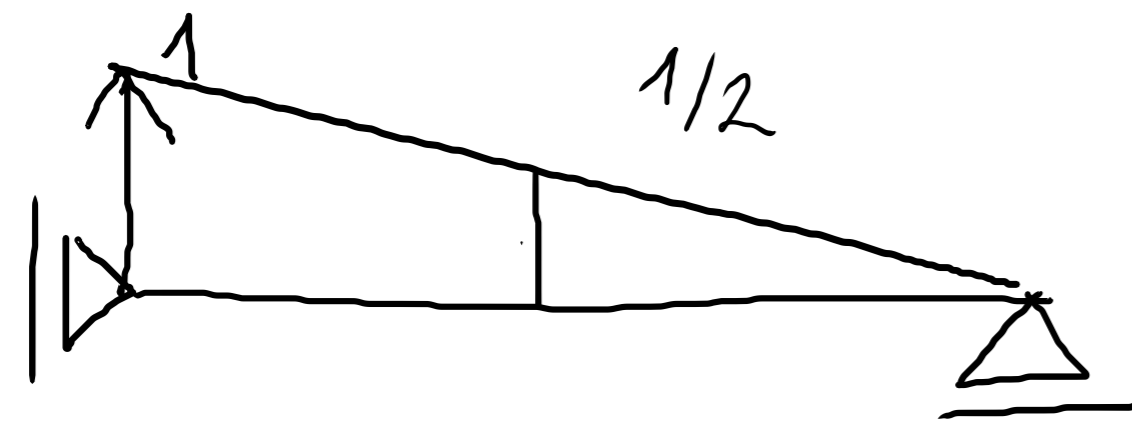

$A = \frac{1}{2} \text{ kN}$ $B = \frac{1}{2} \text{ kN}$
 $V_x = +\frac{1}{2} \text{ kN}$

B

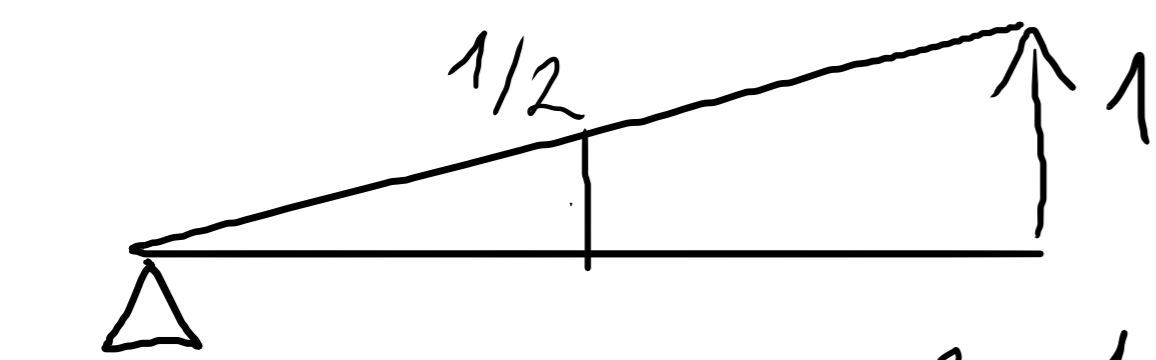

(V)

V_x

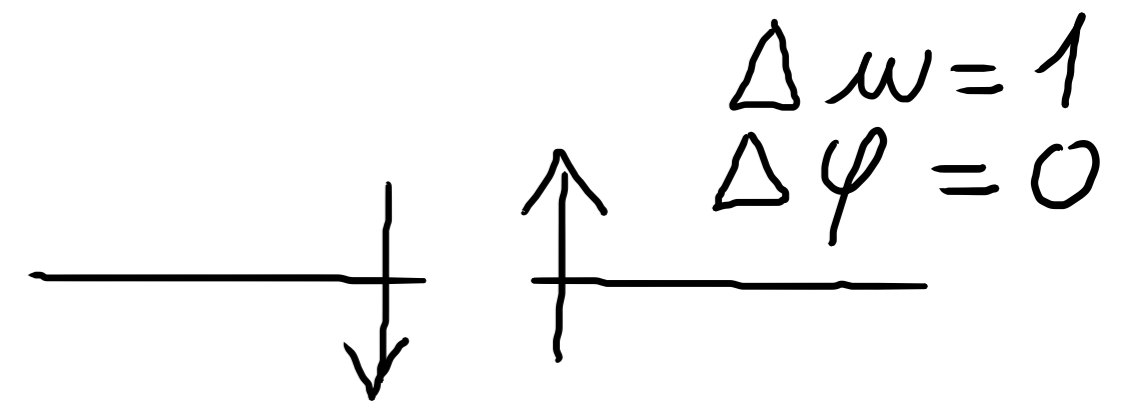

V_x

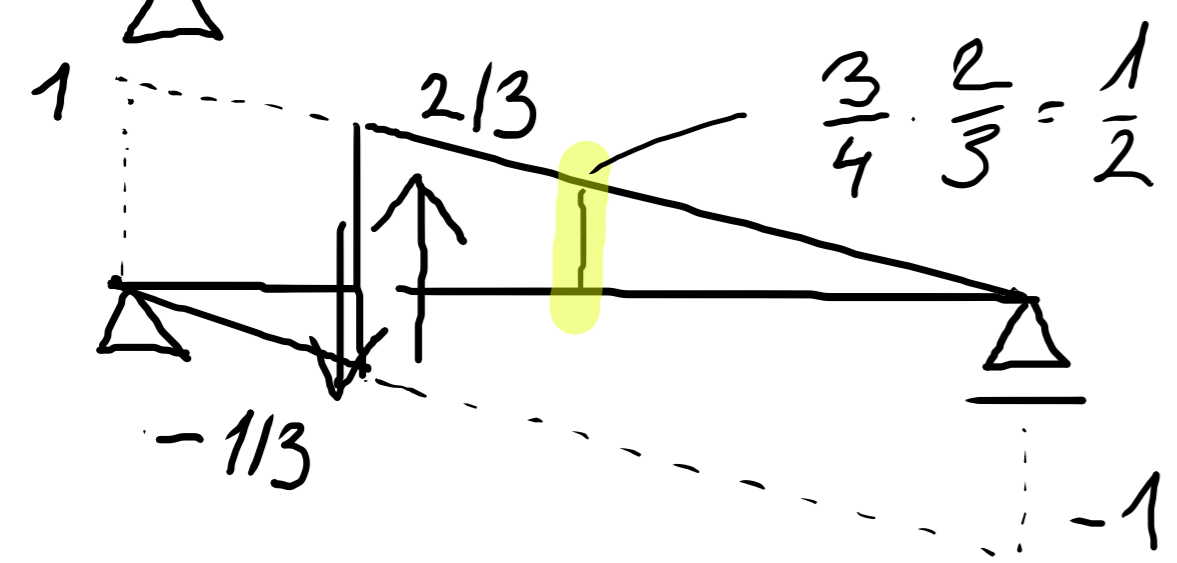

M_x

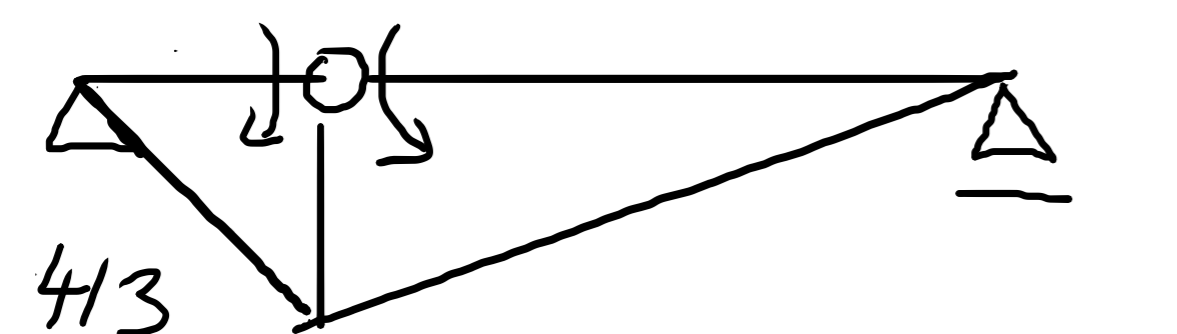

$\frac{2 \cdot 4}{6} = \frac{8}{6} = \frac{4}{3}$

M_x

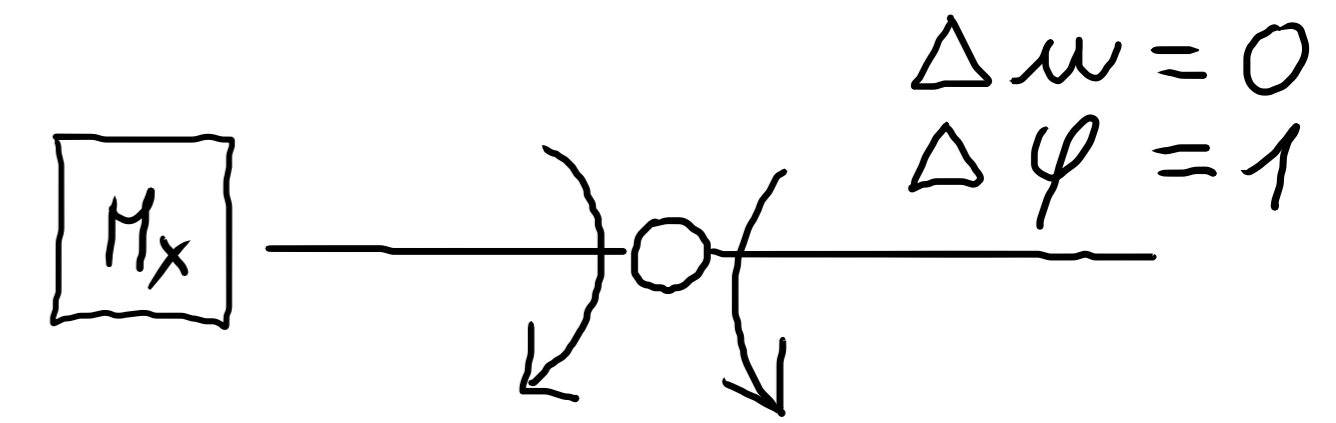

P.Č. - STATICKY URČITĚ KONSTRUKCE

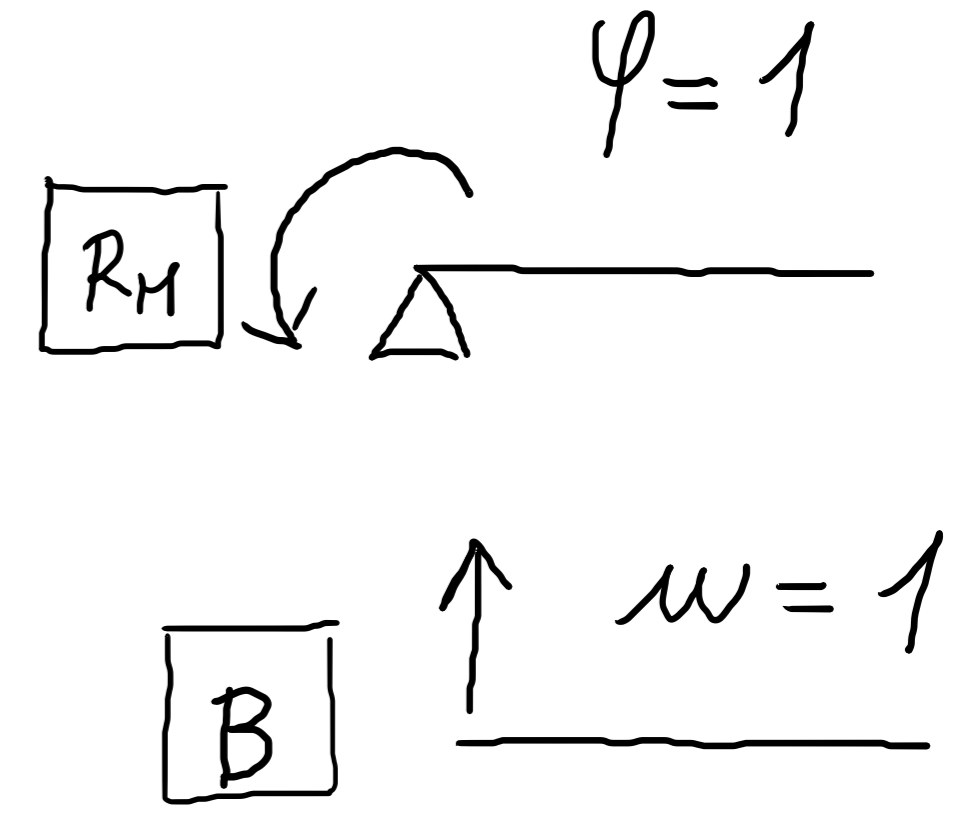
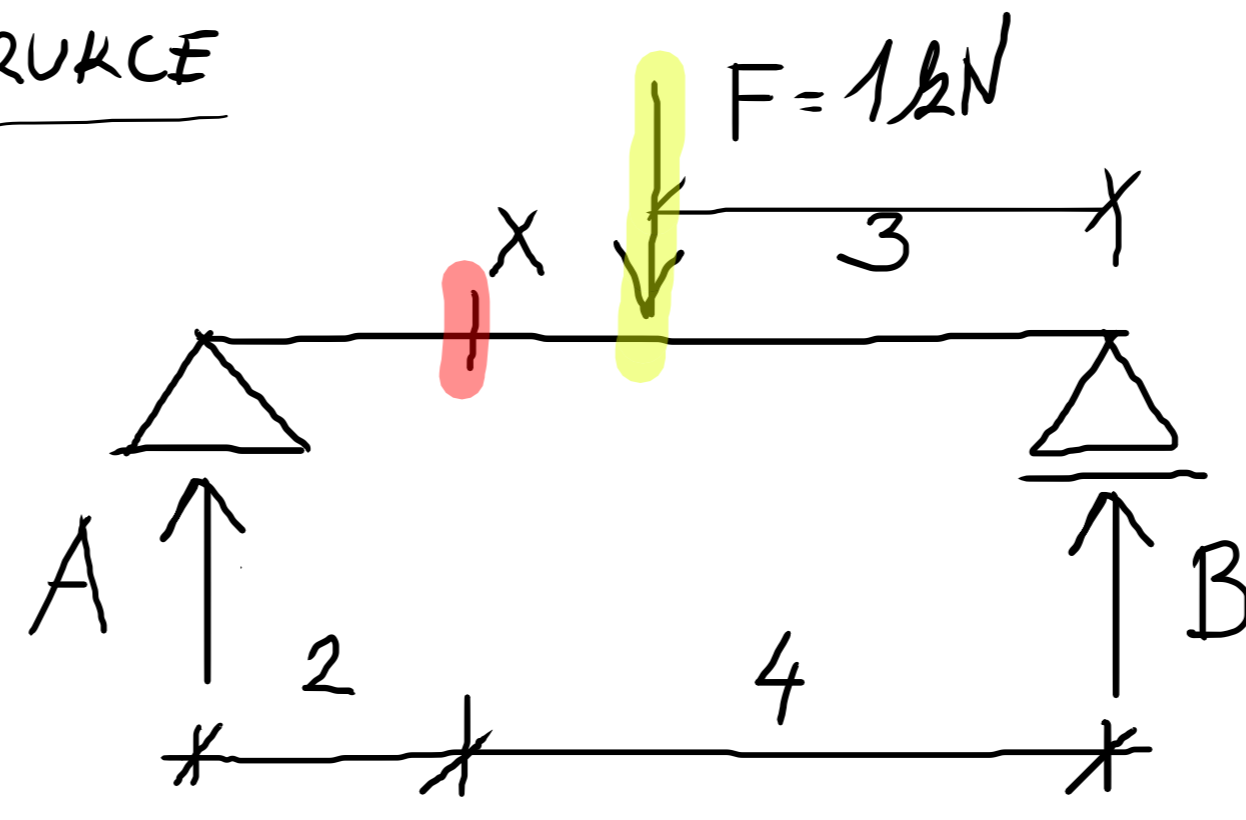
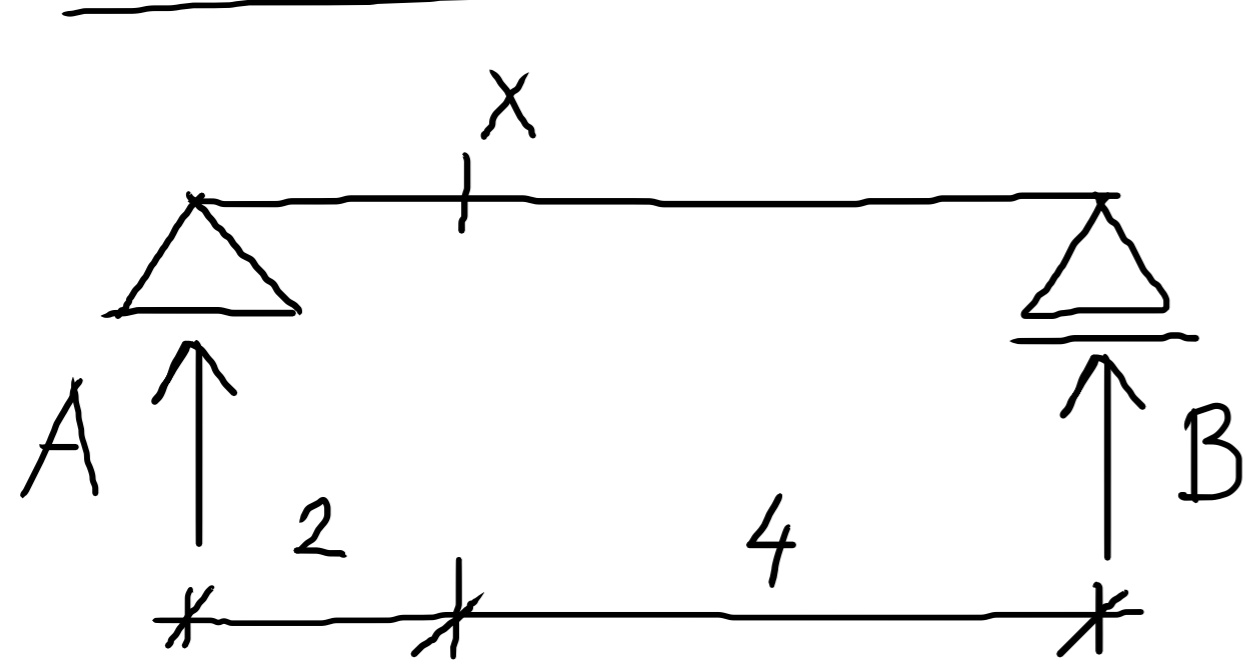

A

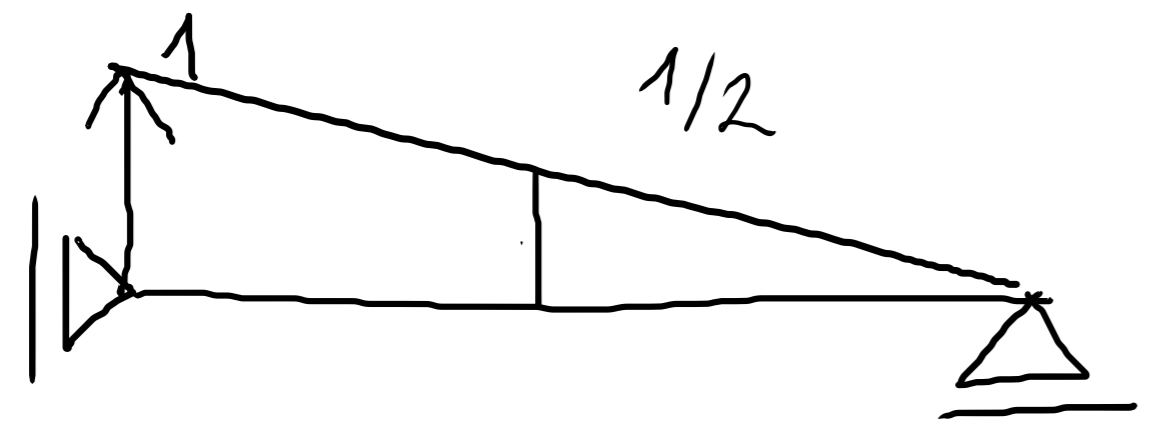

$A = \frac{1}{2} \text{ kN}$ $B = \frac{1}{2} \text{ kN}$
 $V_x = +\frac{1}{2} \text{ kN}$

B

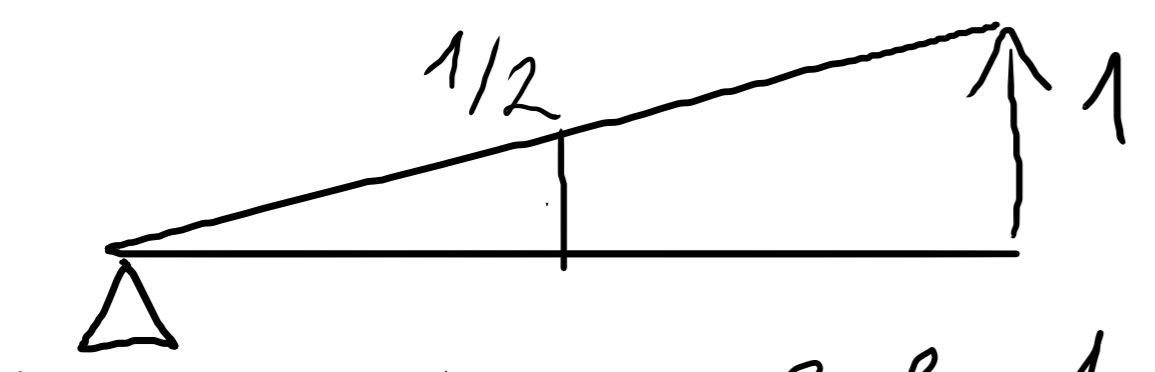

(V)

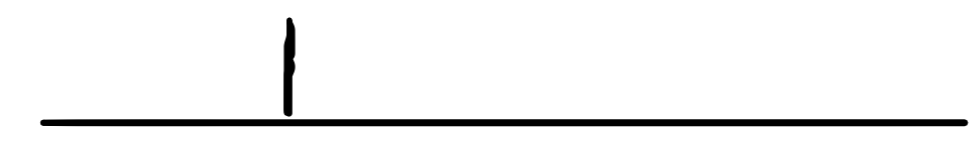

V_x

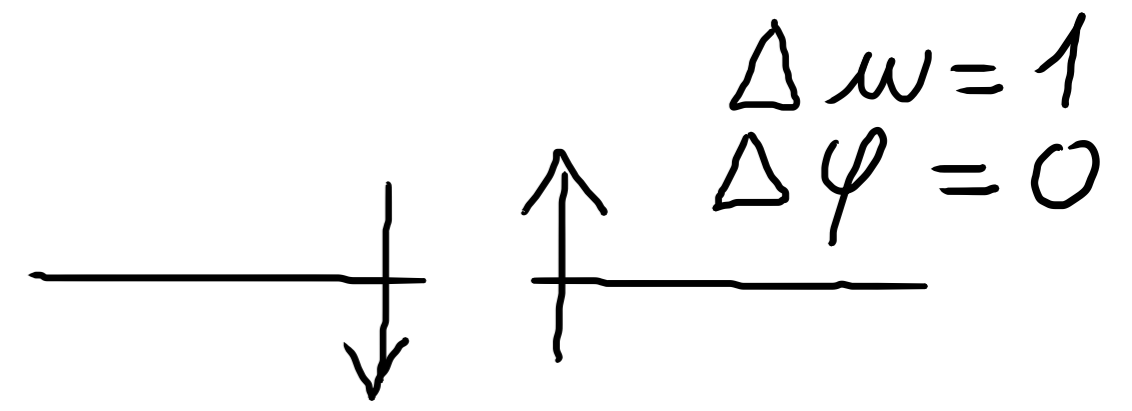

V_x

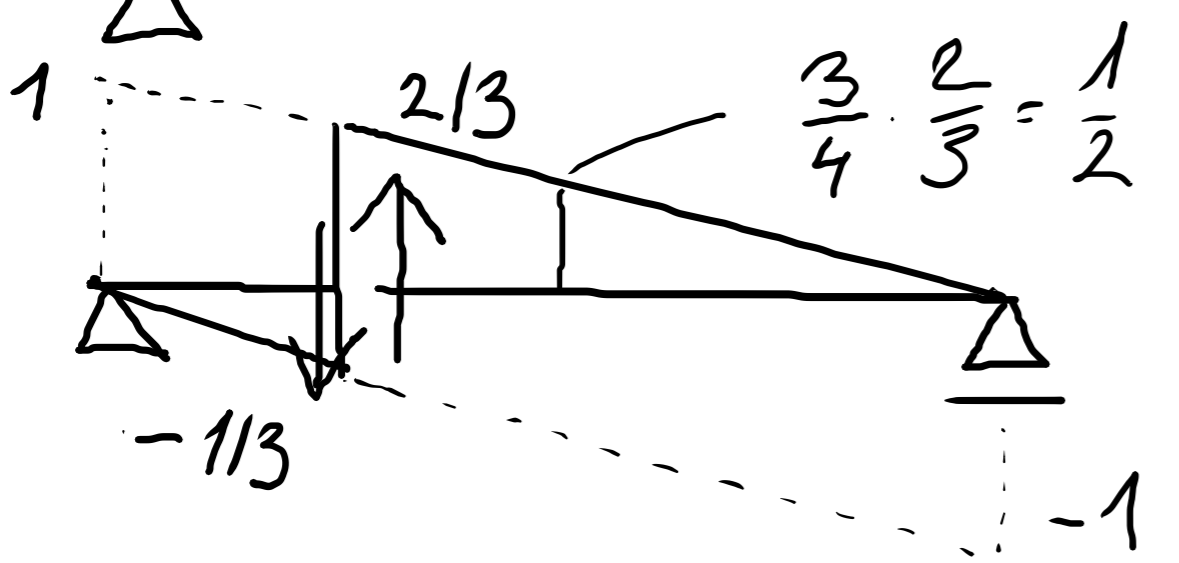

(M)



M_x

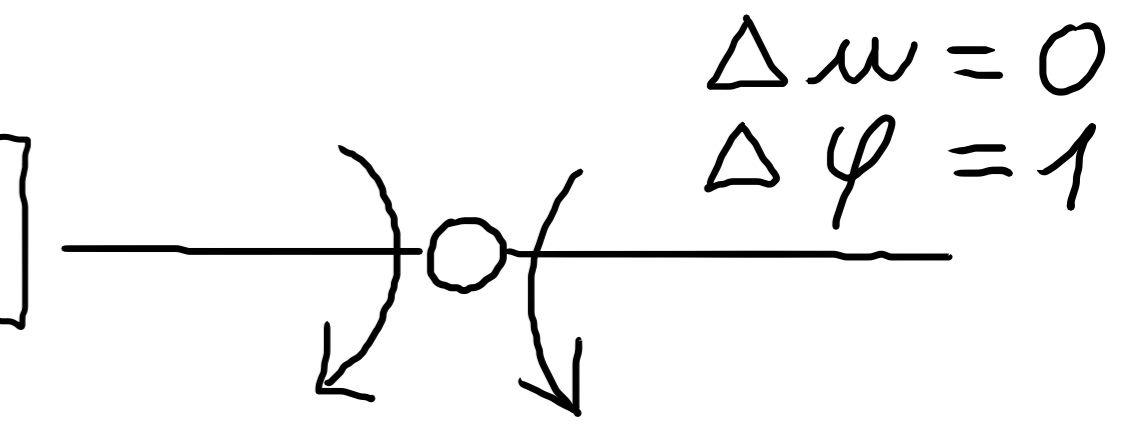

M_x

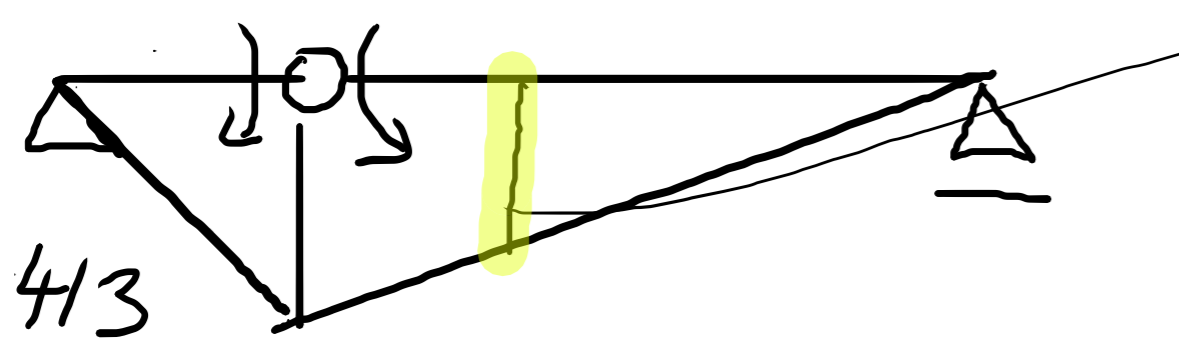

$\frac{2 \cdot 4}{6} = \frac{8}{6} = \frac{4}{3}$

$M_x = \frac{3}{4} \cdot \frac{4}{3} = 1 \text{ kNm}$

P.Č. - STATICKY URČITĚ KONSTRUKCE

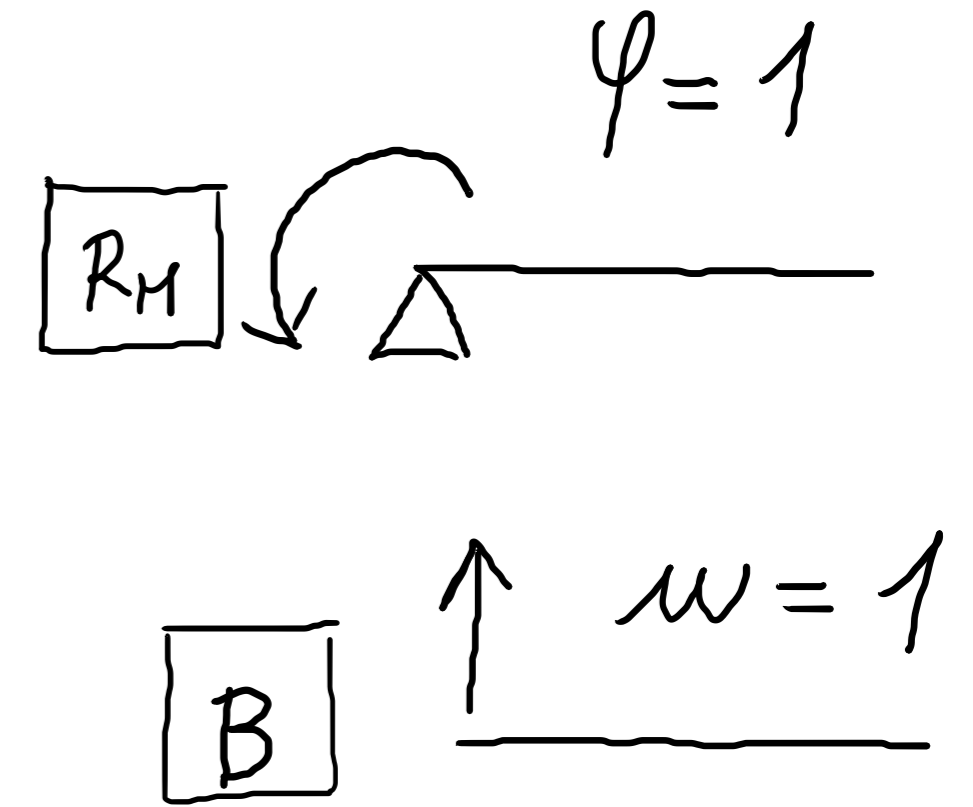
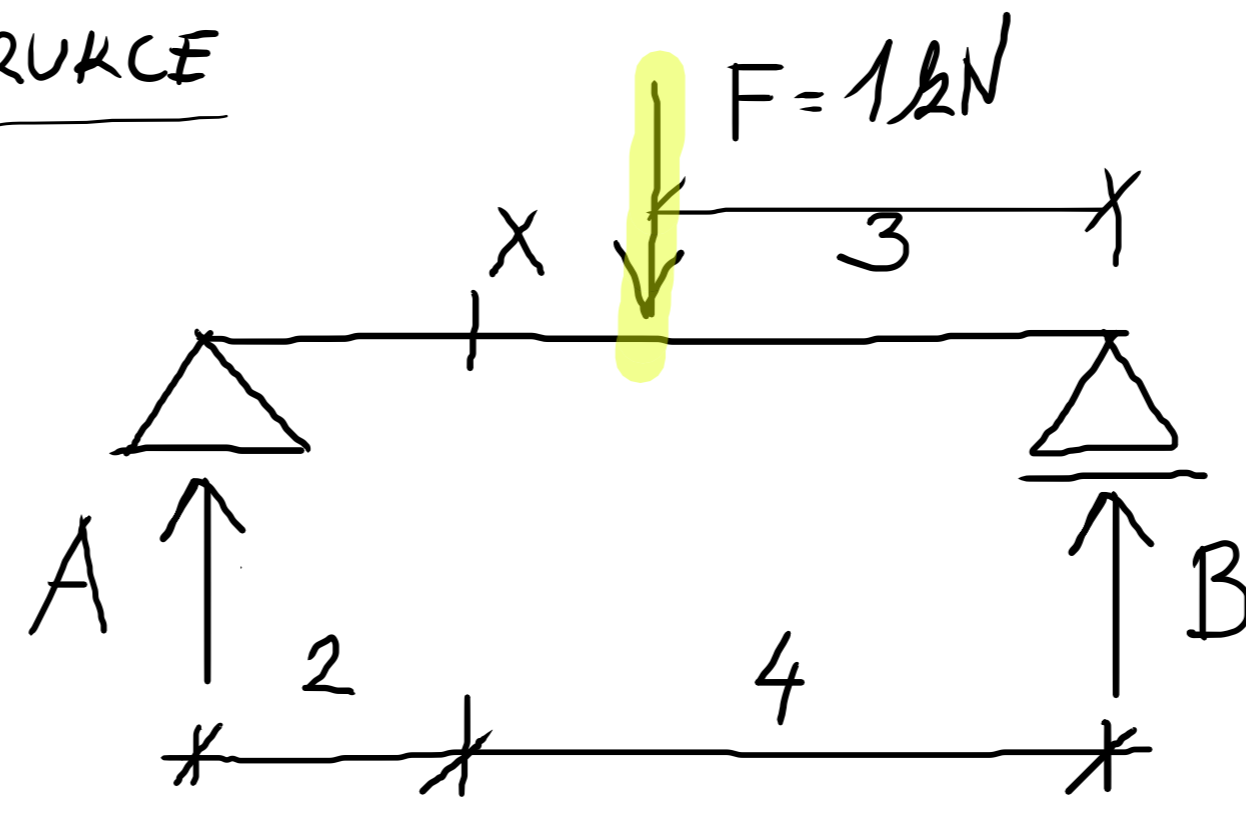
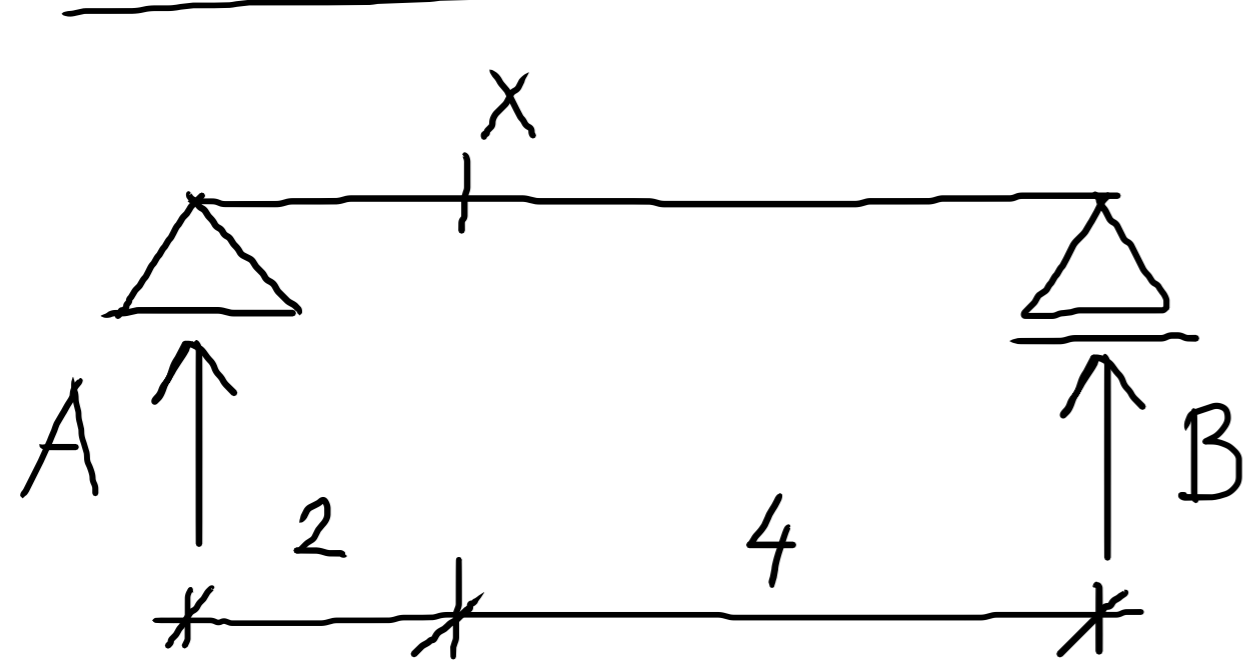

A

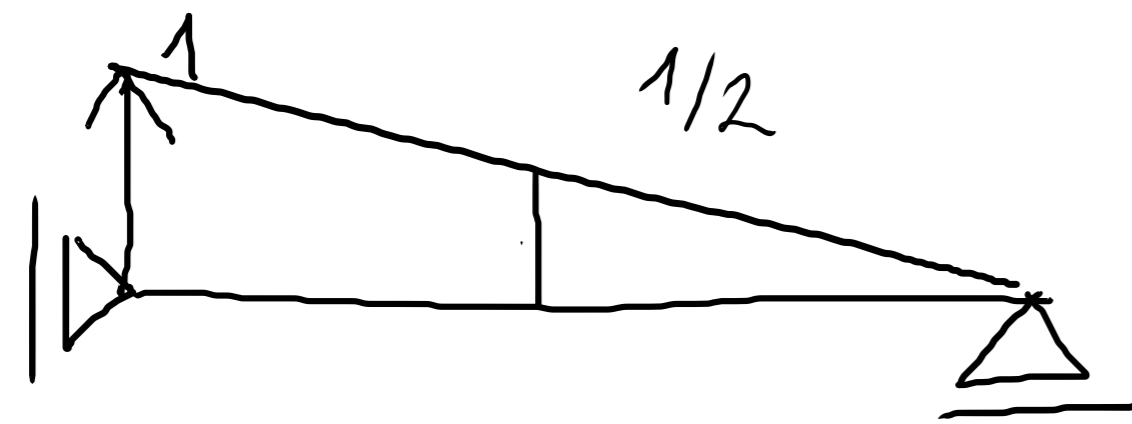

$A = \frac{1}{2} \text{ kN}$ $B = \frac{1}{2} \text{ kN}$
 $V_x = +\frac{1}{2} \text{ kN}$

B

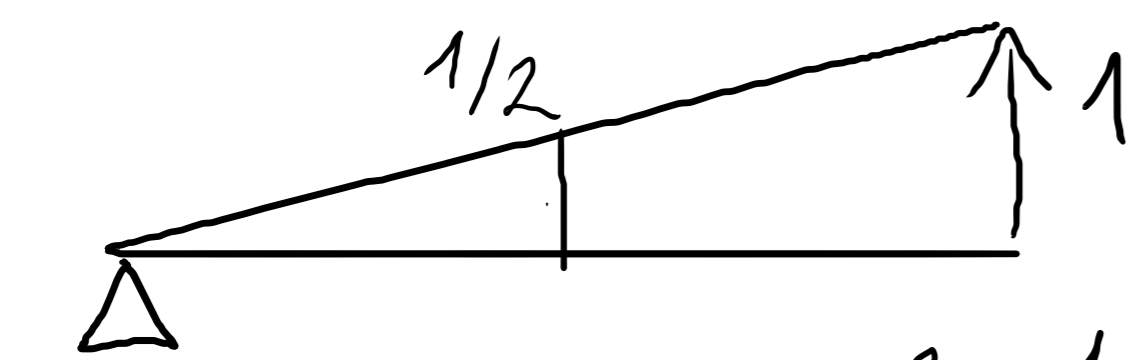

(V)

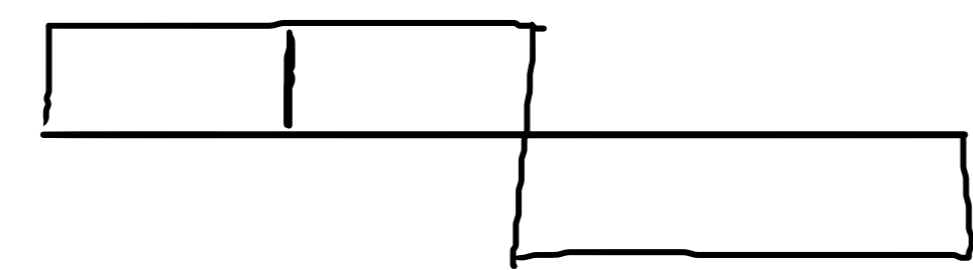

V_x

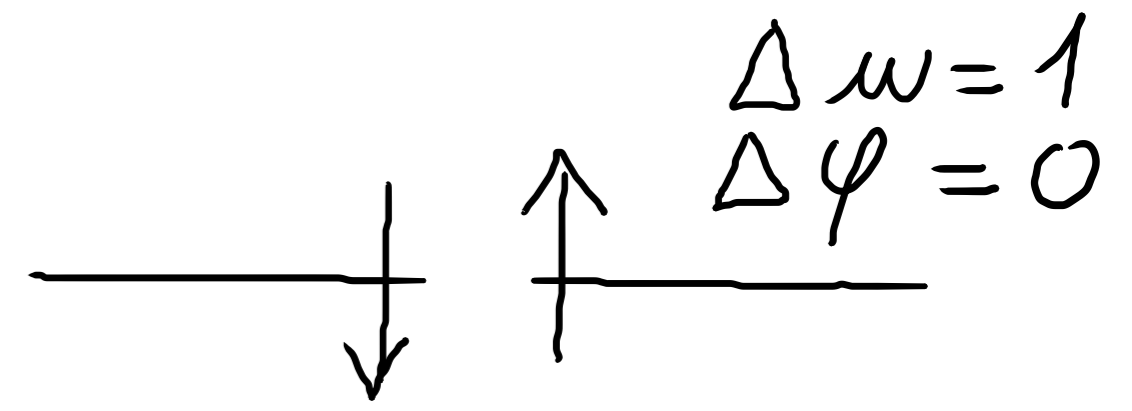

V_x

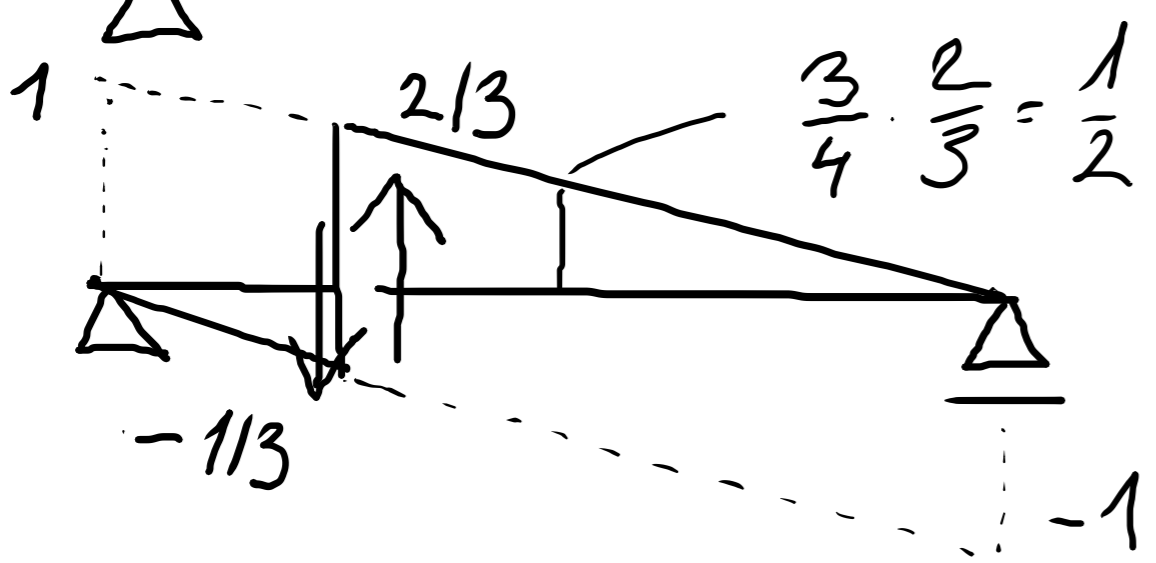

(M)



M_x

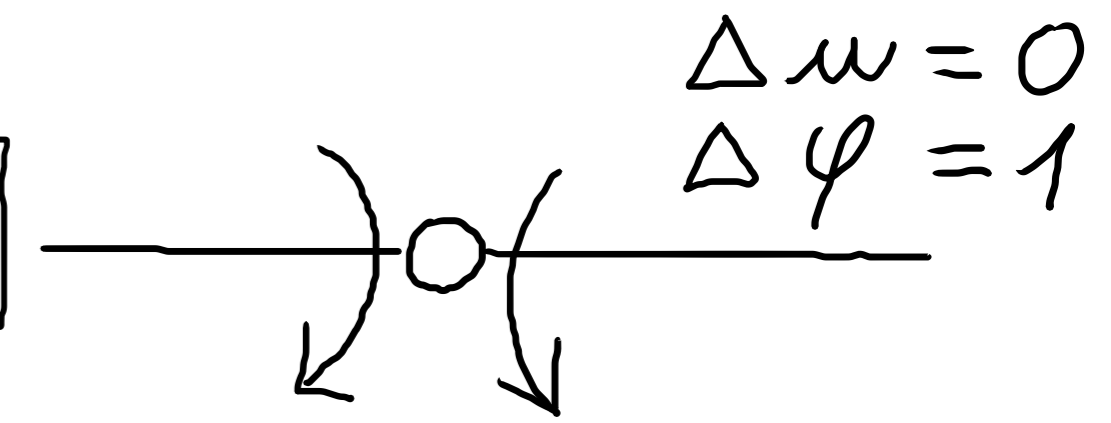

M_x

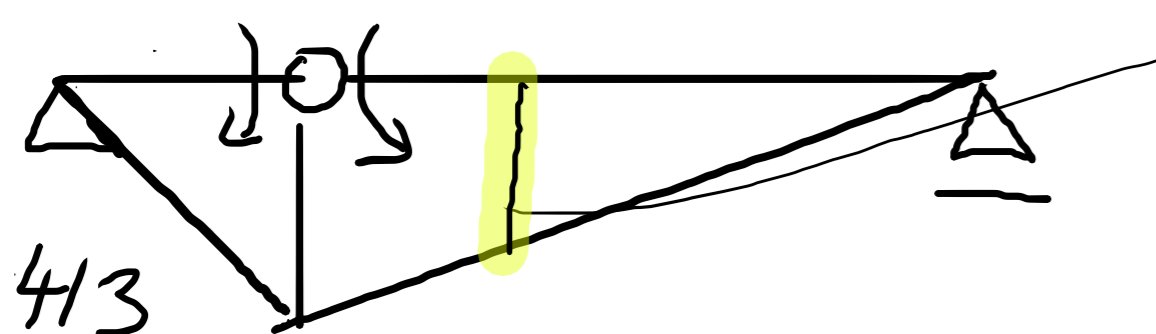

$\frac{2 \cdot 4}{6} = \frac{8}{6} = \frac{4}{3}$

$M_x = \frac{3}{4} \cdot \frac{4}{3} = 1 \text{ kNm}$

PŘÍČINKOVÉ ČÁRY - GERBERŮV NOSNÍK

PŘÍČINKOVÉ ČÁRY - GERBERŮV NOSNÍK



PŘÍČINKOVÉ ČÁRY - GERBERŮV NOSNÍK

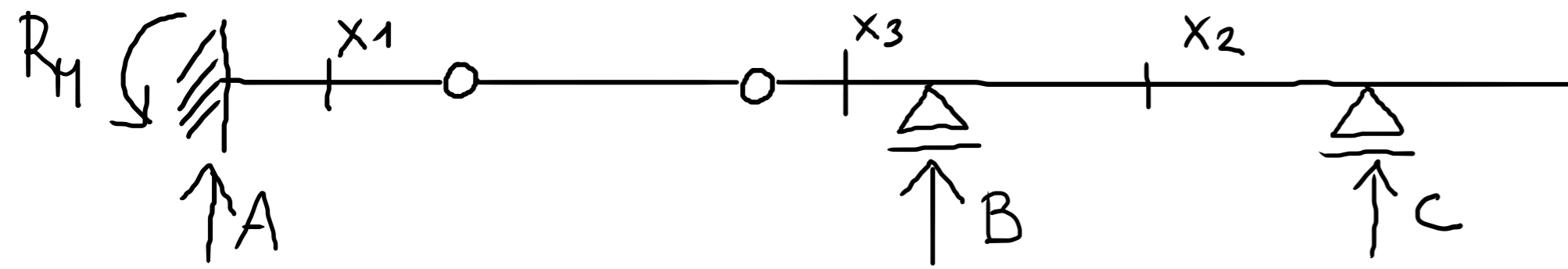

PŘÍČINKOVÉ ČÁRY - GERBERŮV NOSNÍK

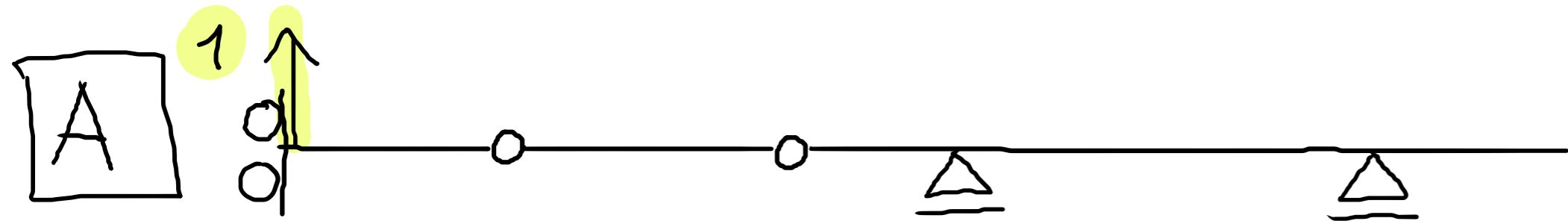
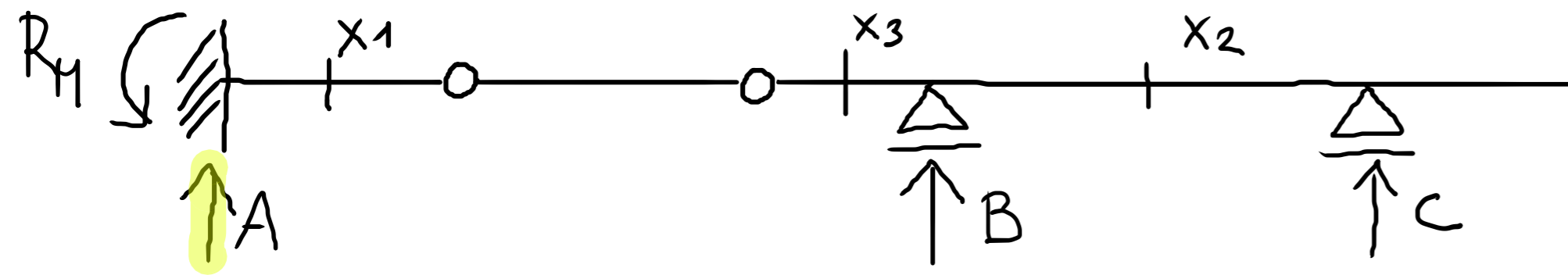

PŘÍČINKOVÉ ČÁRY - GERBERŮV NOSNÍK

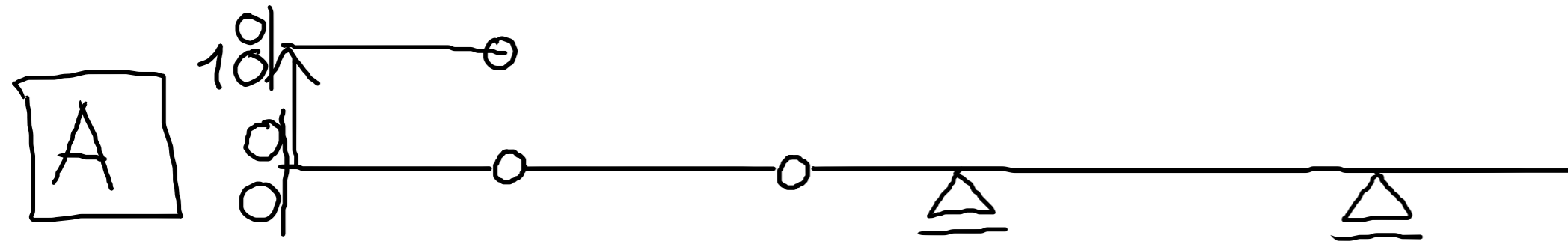
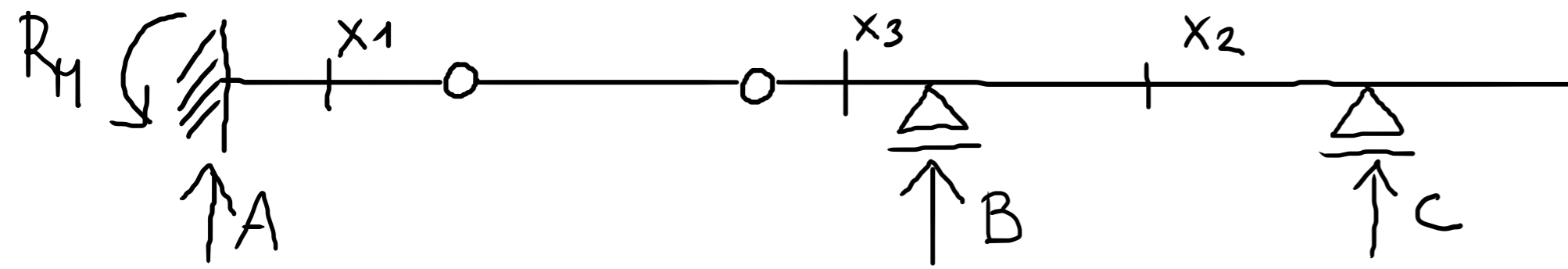

PŘÍČINKOVÉ ČÁRY - GERBERŮV NOSNÍK

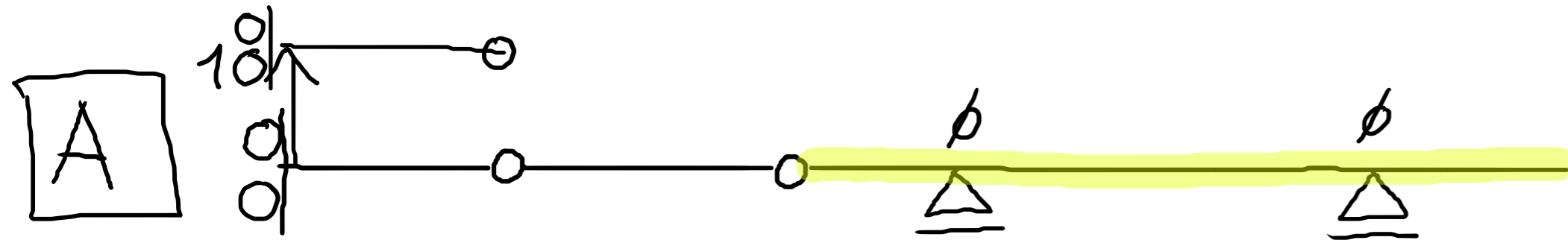
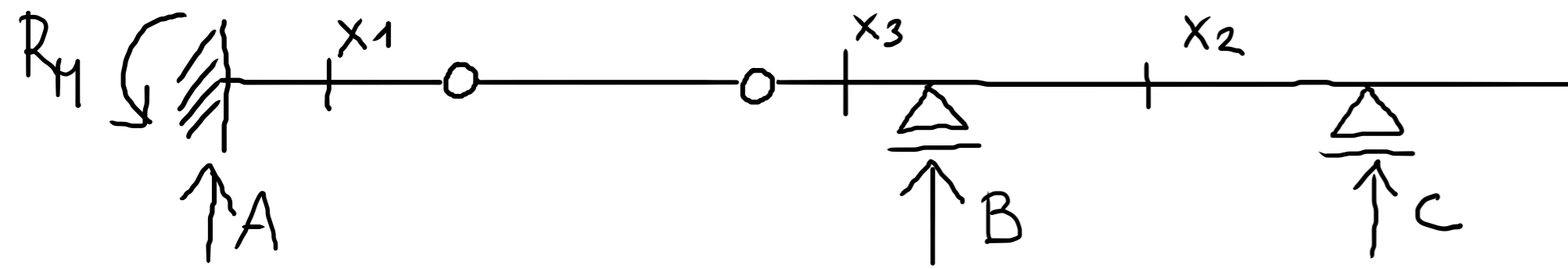

PŘÍČINKOVÉ ČÁRY - GERBERŮV NOSNÍK

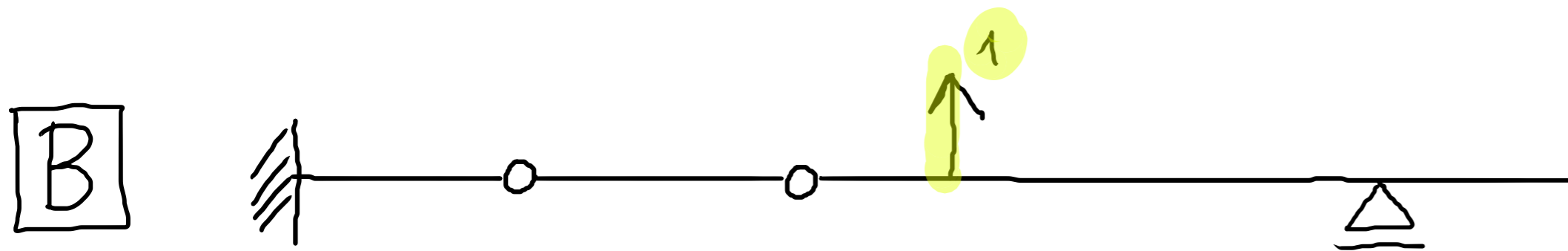
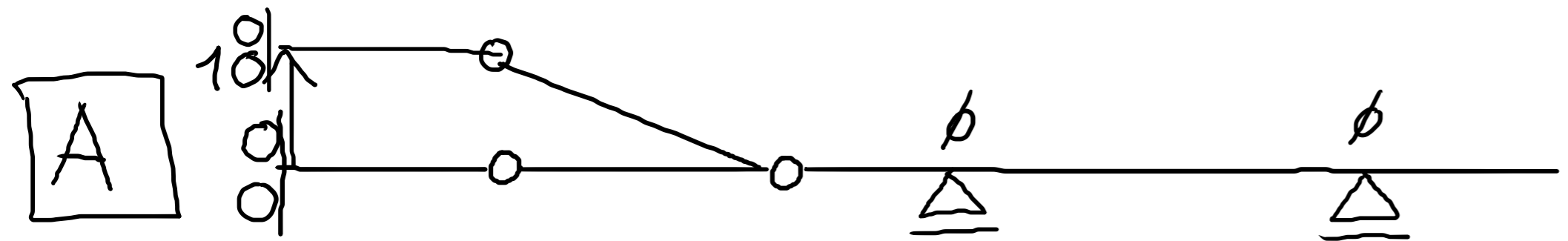
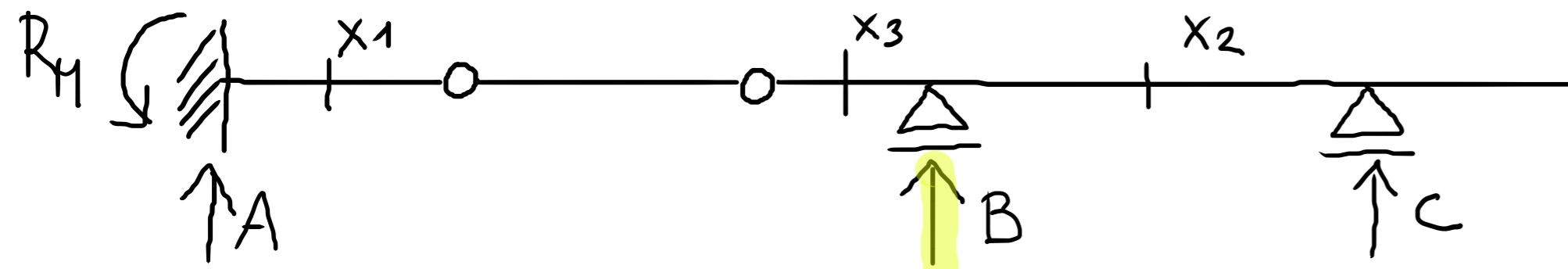

PŘÍČINKOVÉ ČÁRY - GERBERŮV NOSNÍK

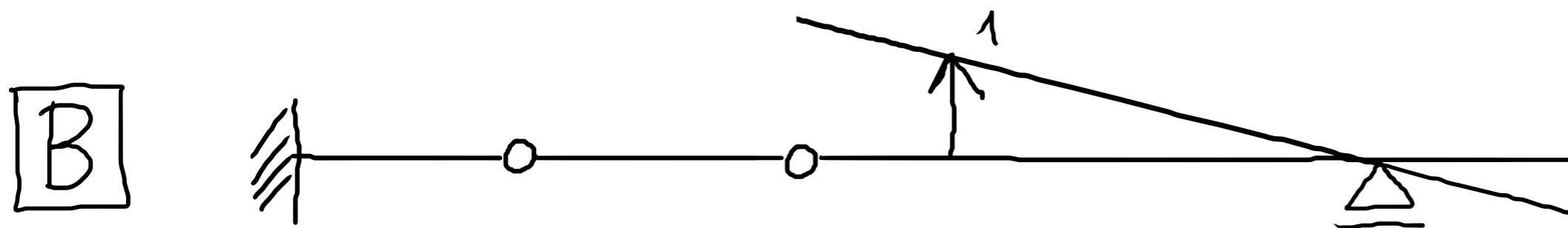
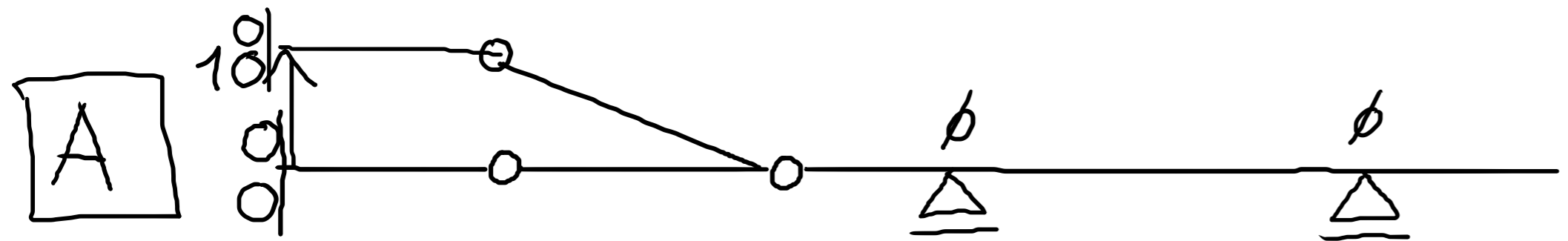
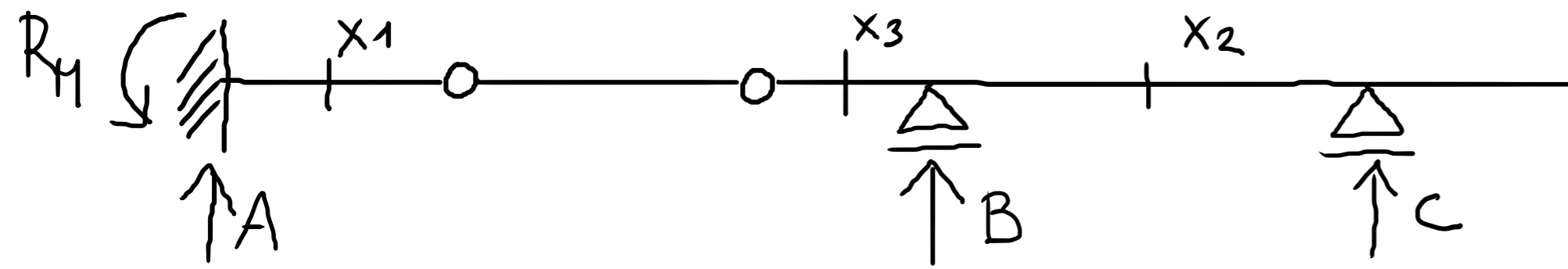

PŘÍČINKOVÉ ČÁRY - GERBERŮV NOSNÍK

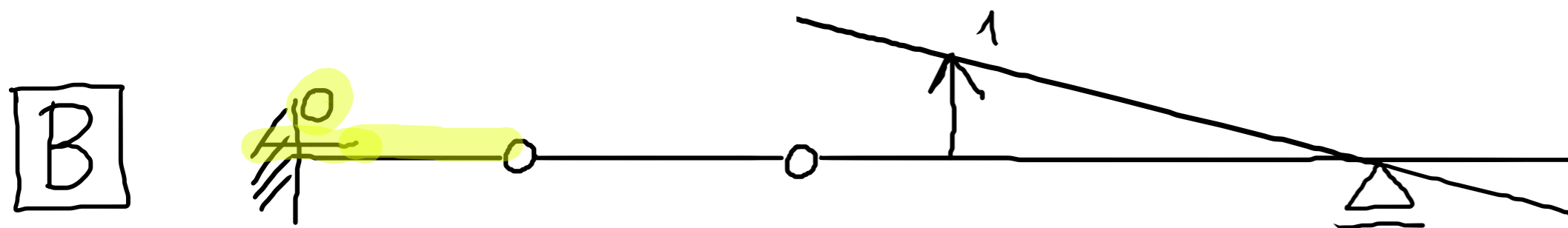
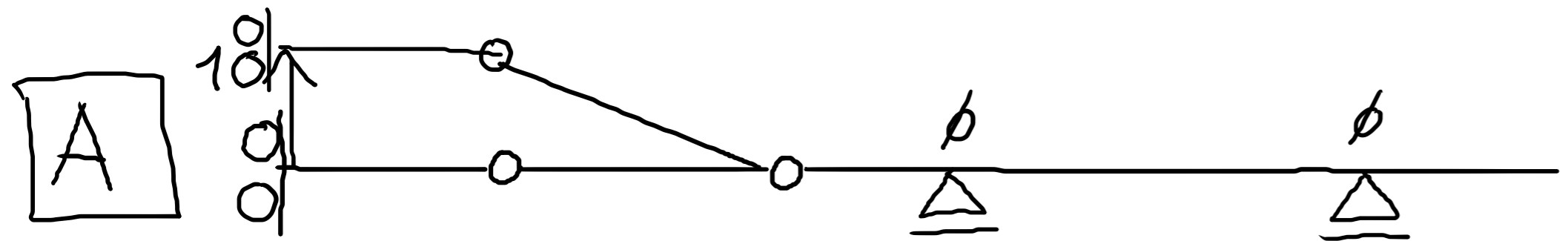
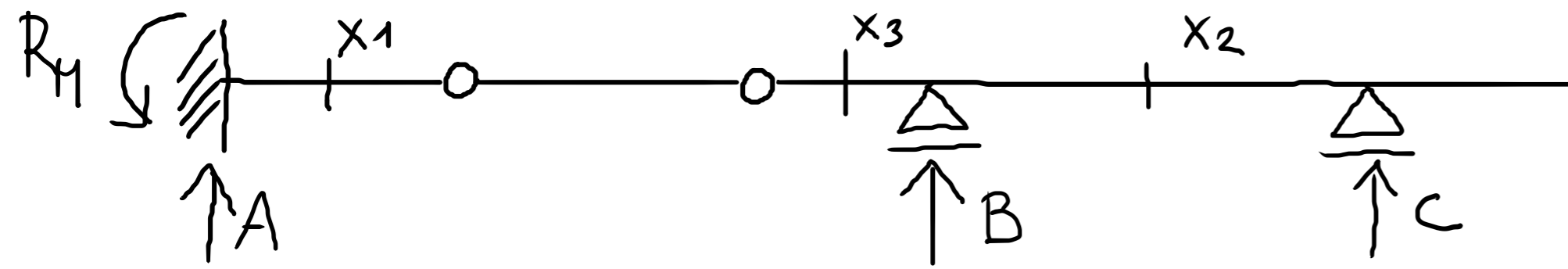

PŘÍČINKOVÉ ČÁRY - GERBERŮV NOSNÍK

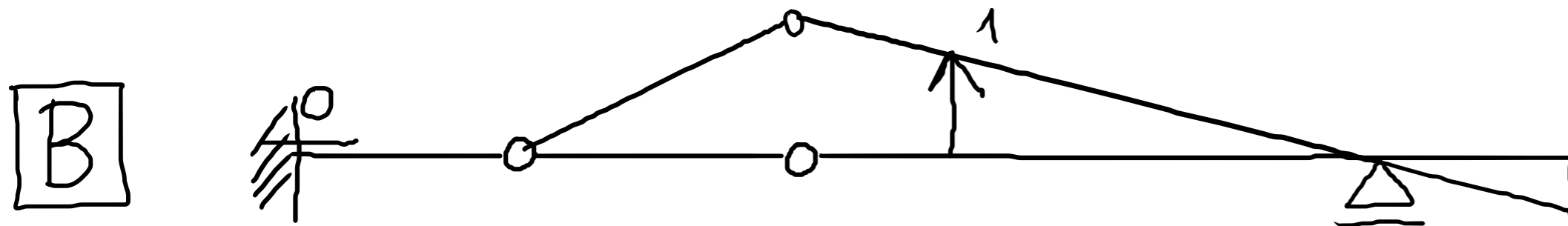
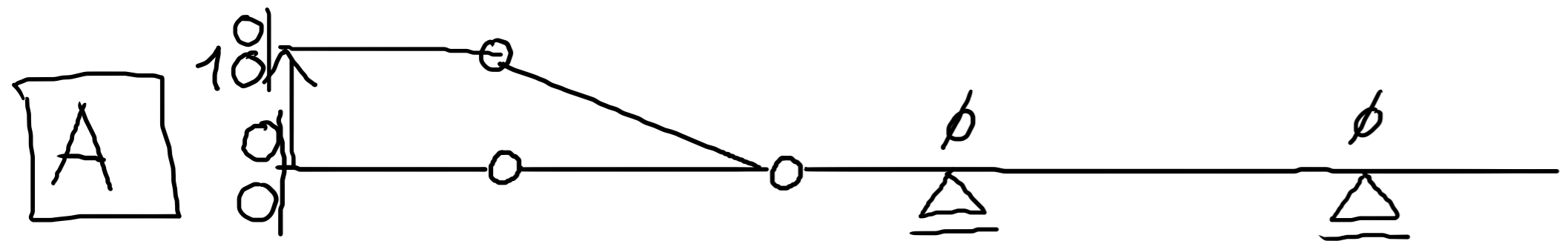
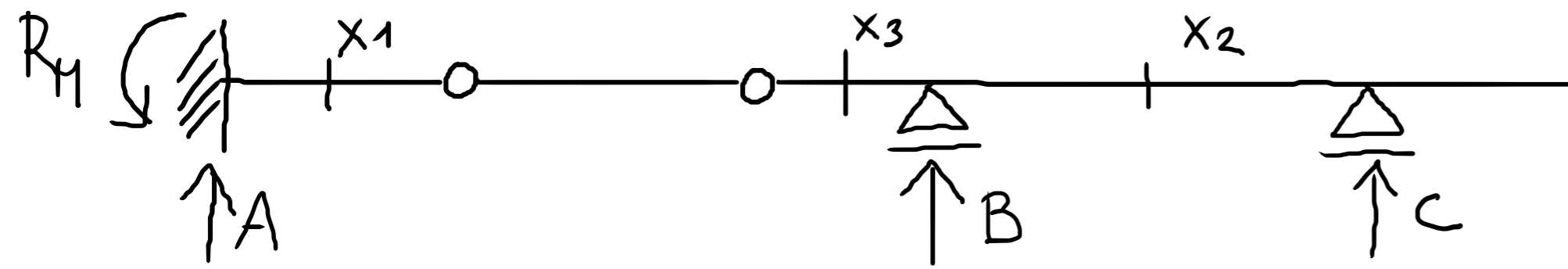

PŘÍČINKOVÉ ČÁRY - GERBERŮV NOSNÍK

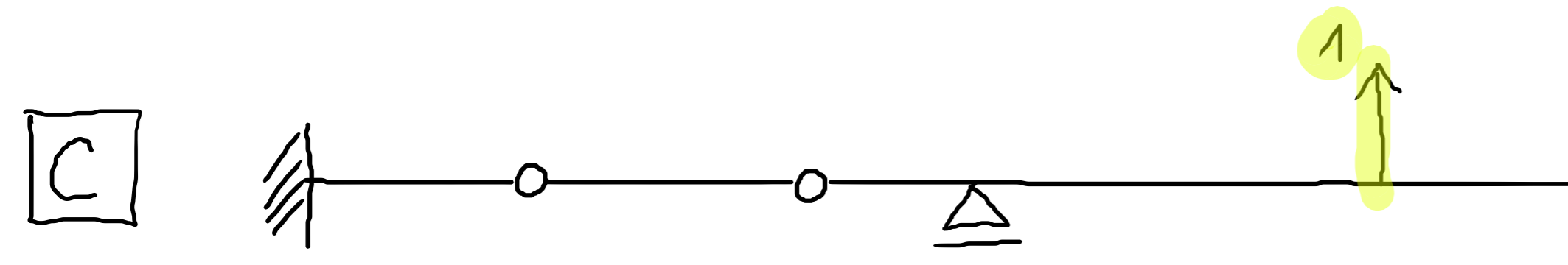
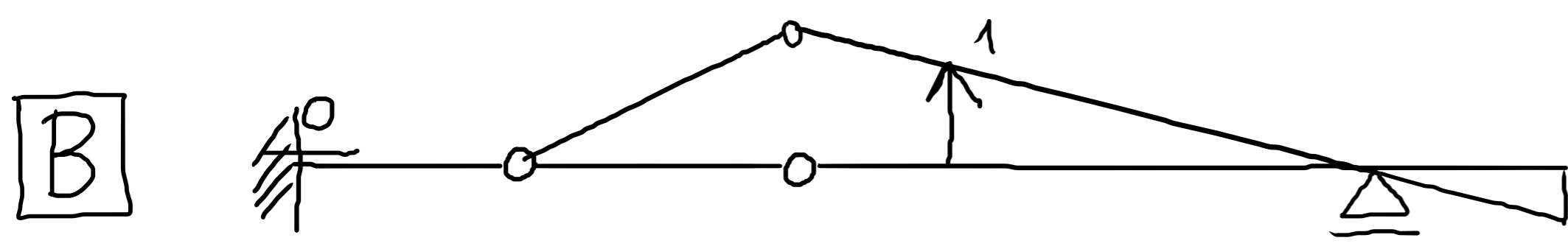
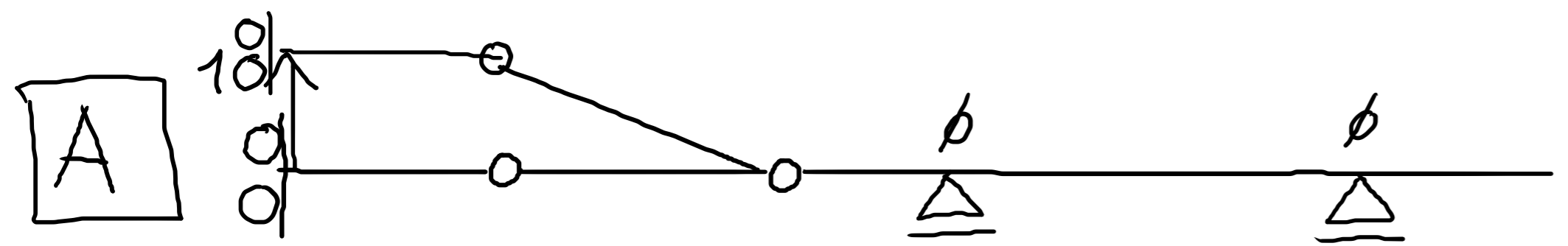
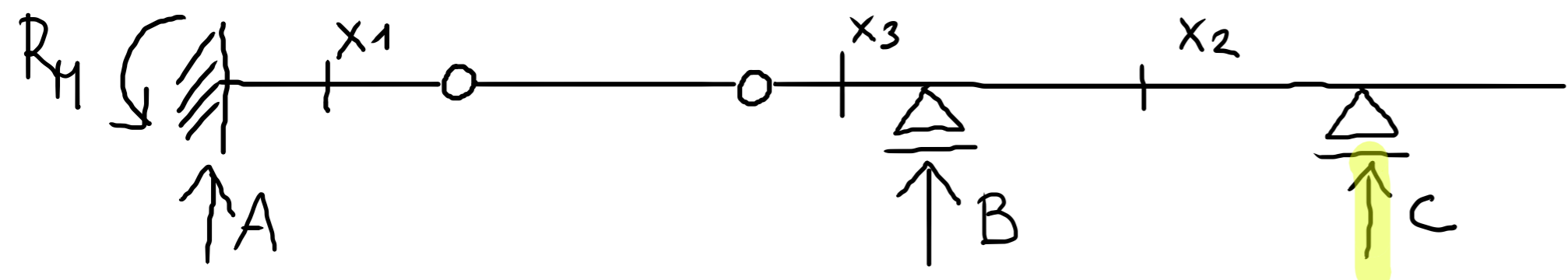

PŘÍČINKOVÉ ČÁRY - GERBERŮV NOSNÍK

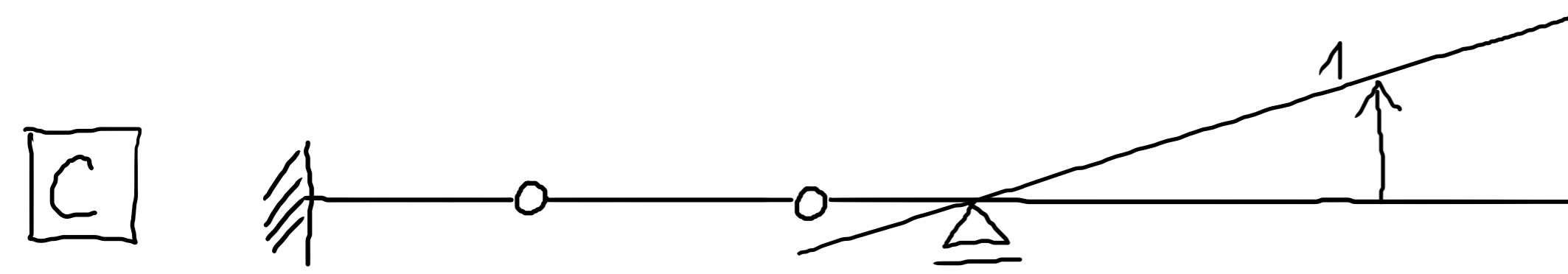
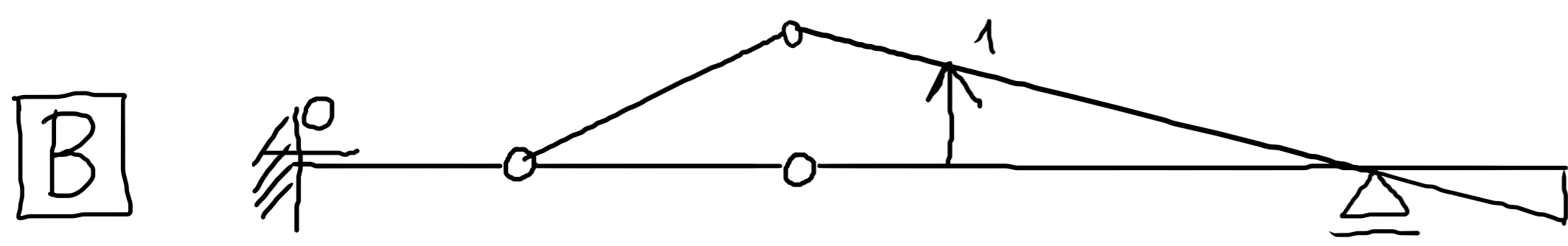
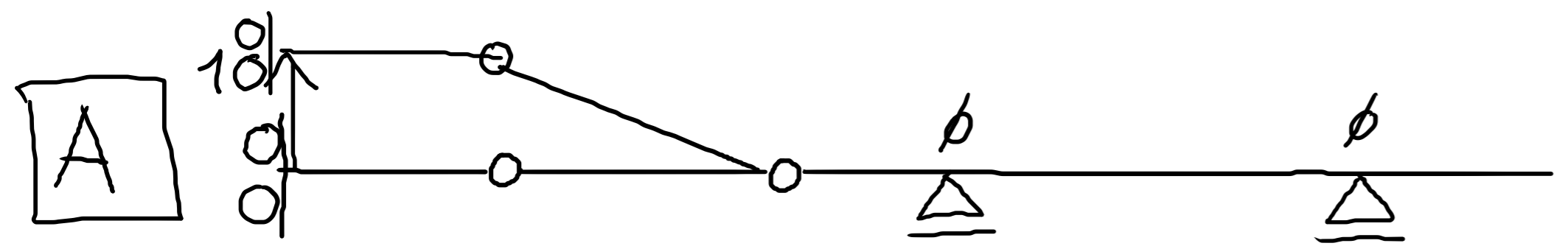
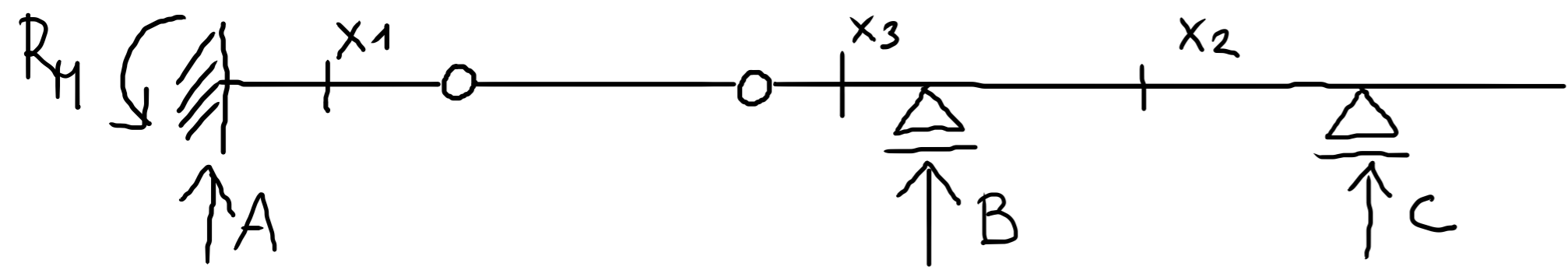

PŘÍČINKOVÉ ČÁRY - GERBERŮV NOSNÍK

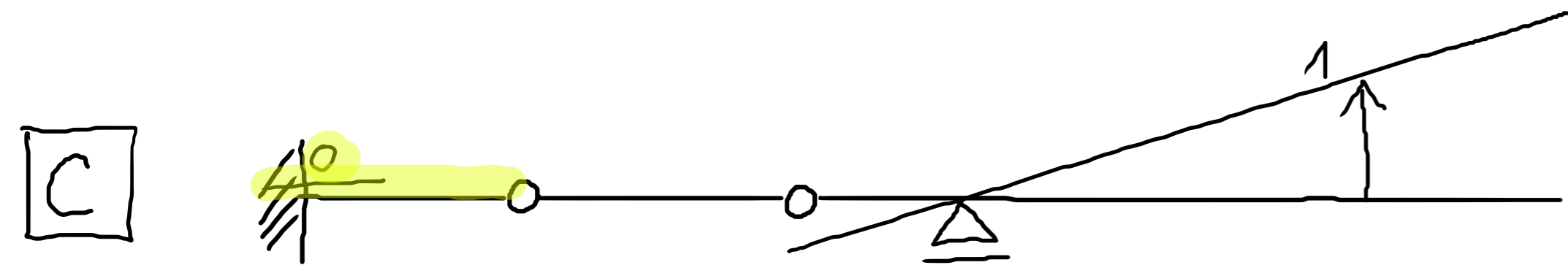
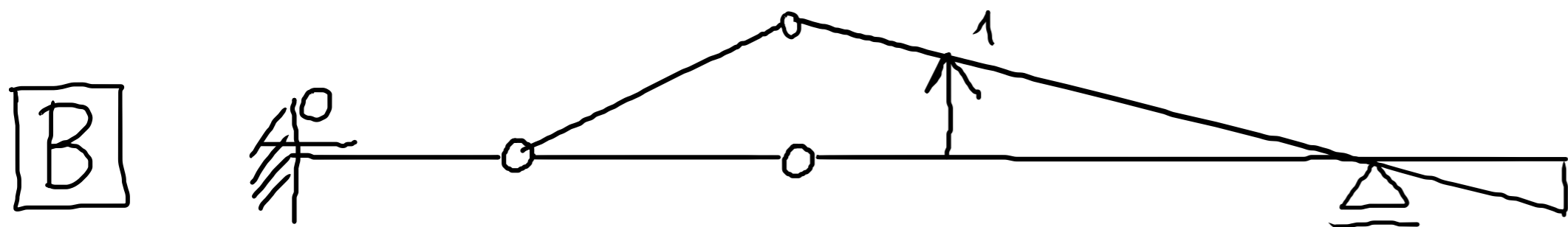
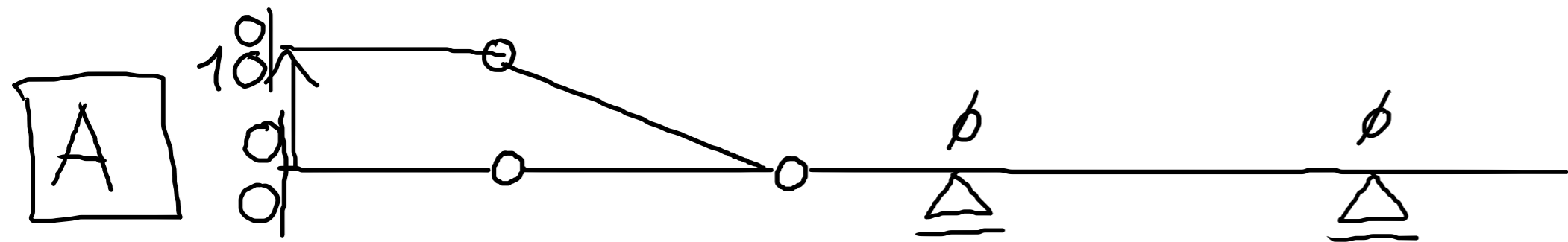
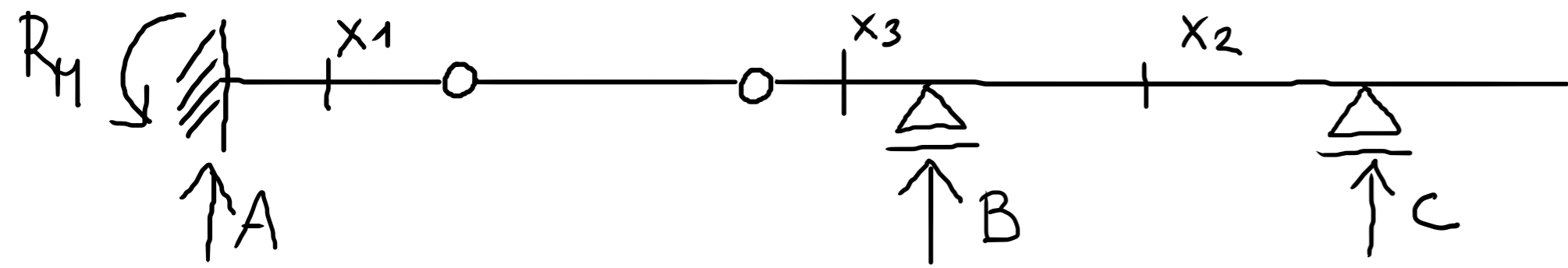

PŘÍČINKOVÉ ČÁRY - GERBERŮV NOSNÍK

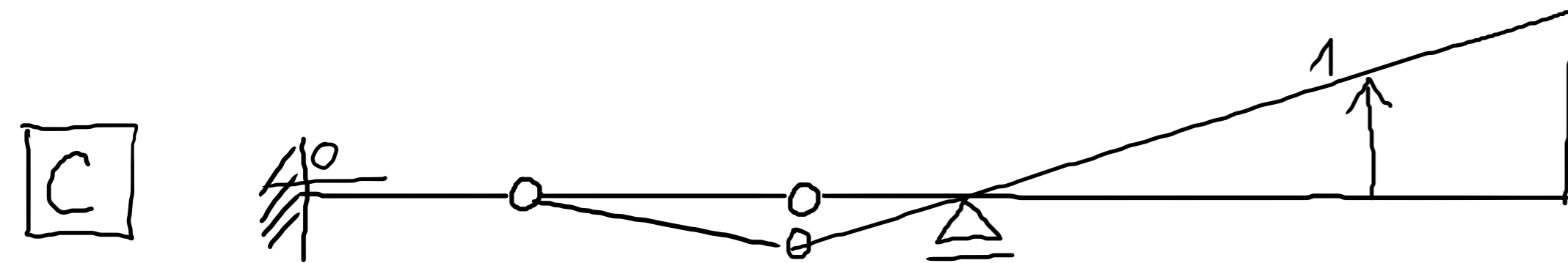
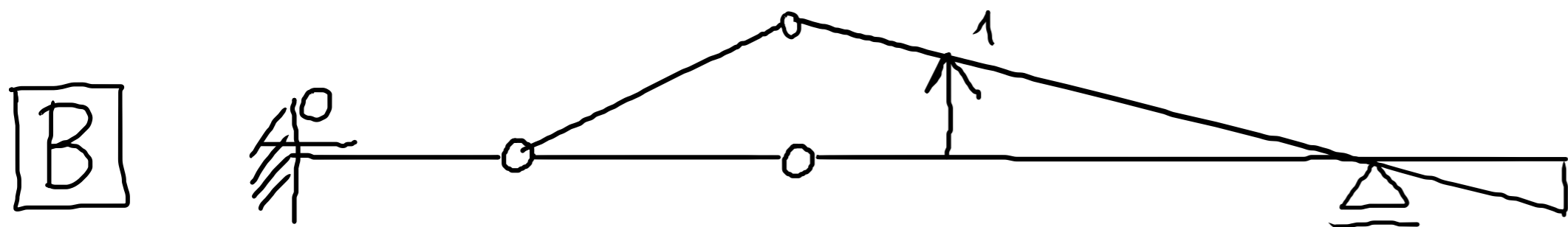
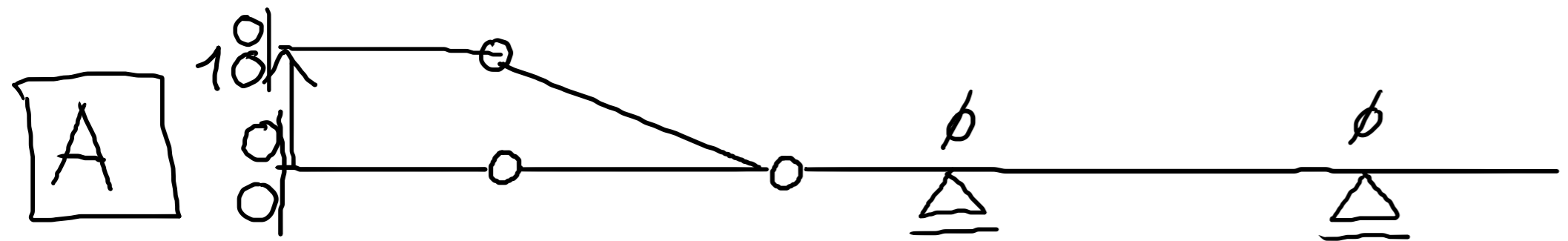
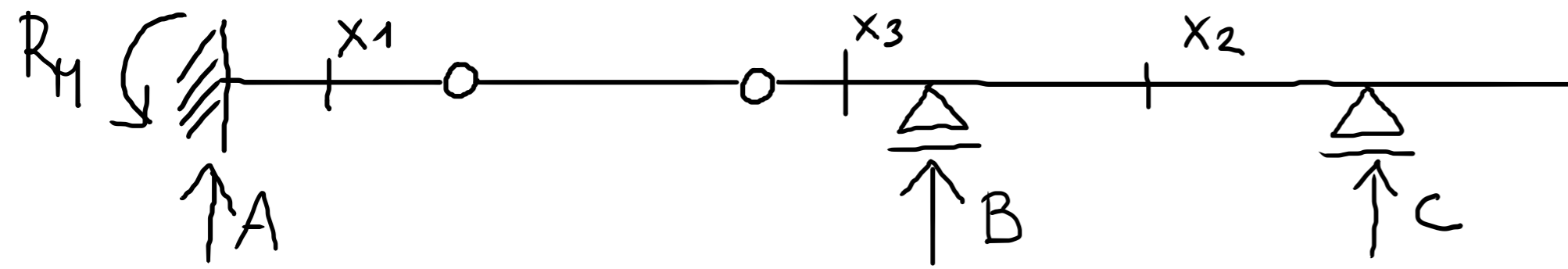

PŘÍČINKOVÉ ČÁRY - GERBERŮV NOSNÍK

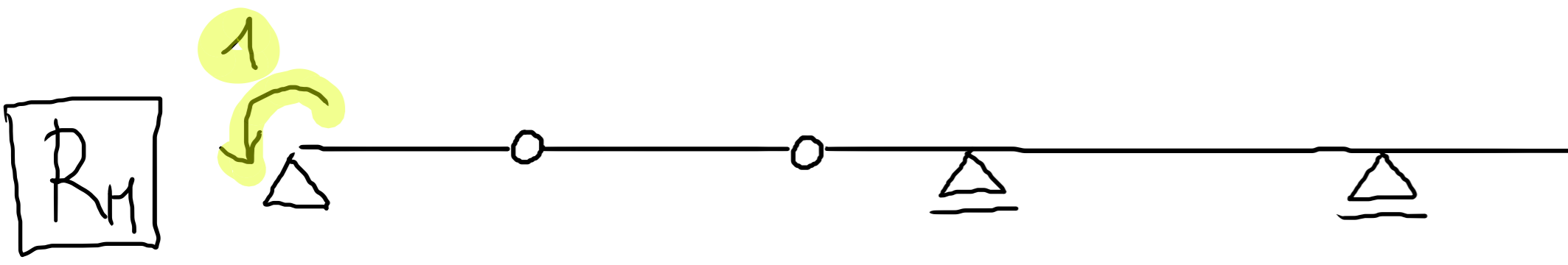
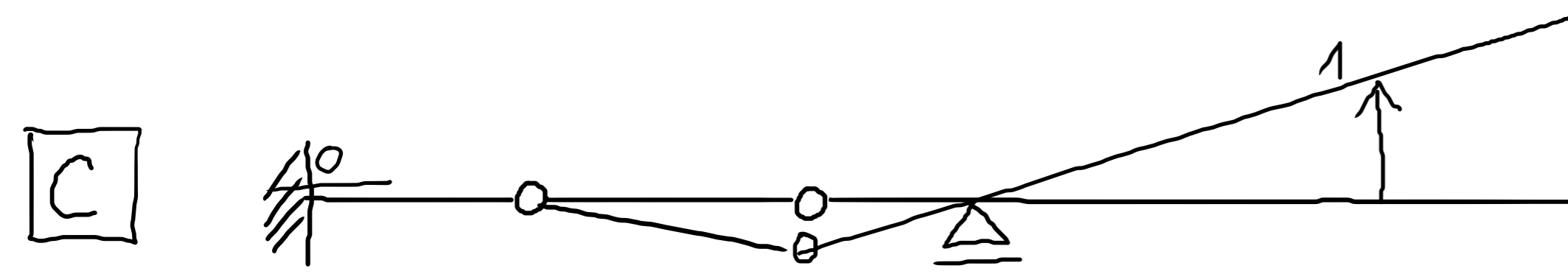
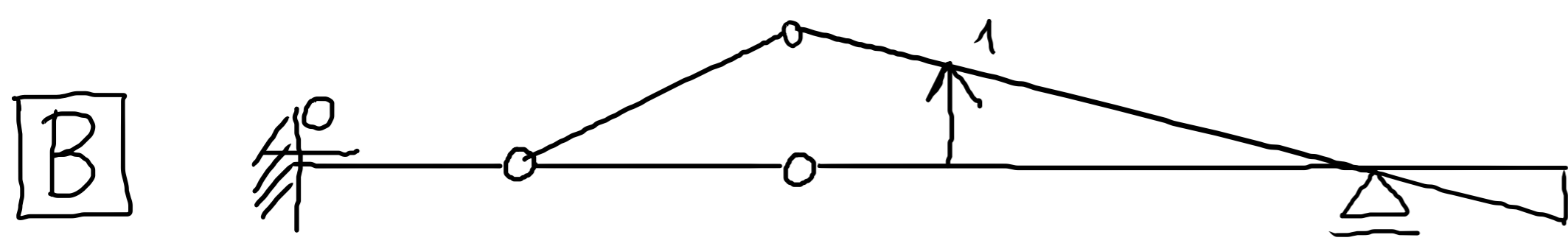
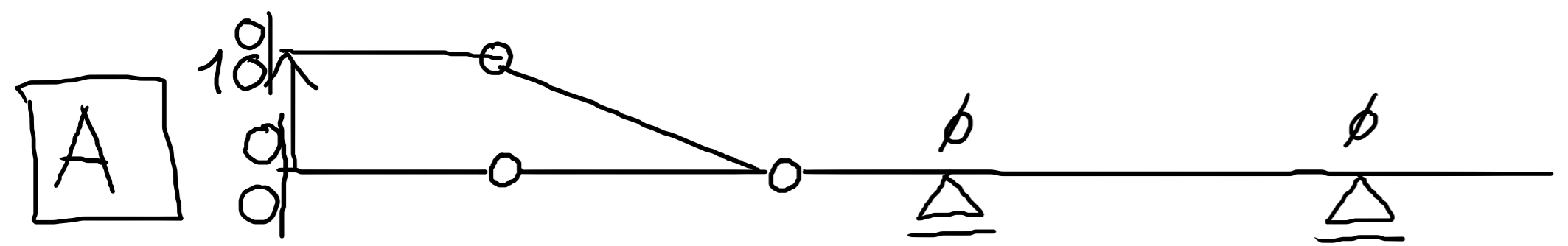
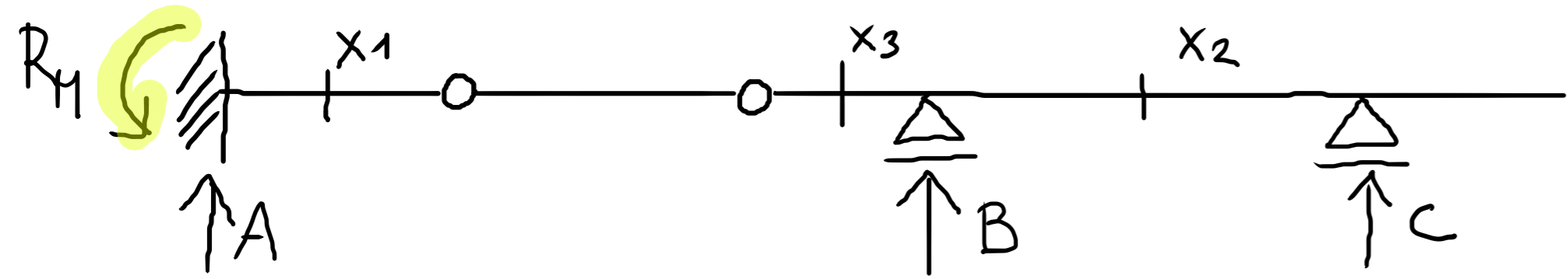

PŘÍČINKOVÉ ČÁRY - GERBERŮV NOSNÍK

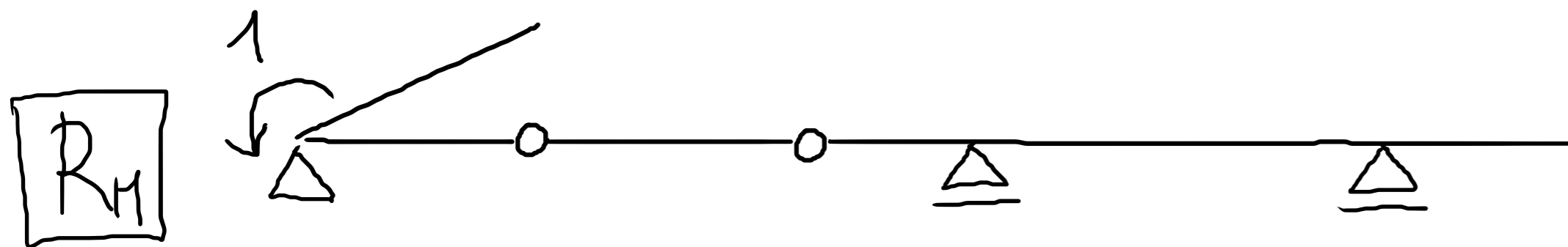
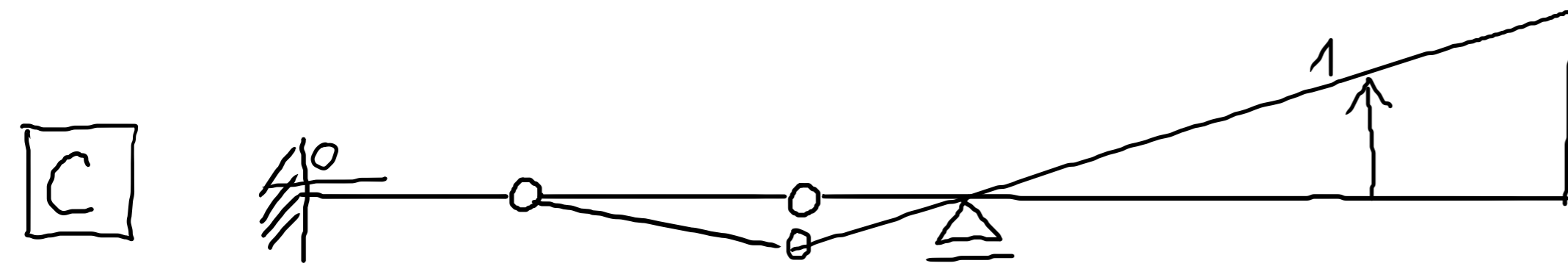
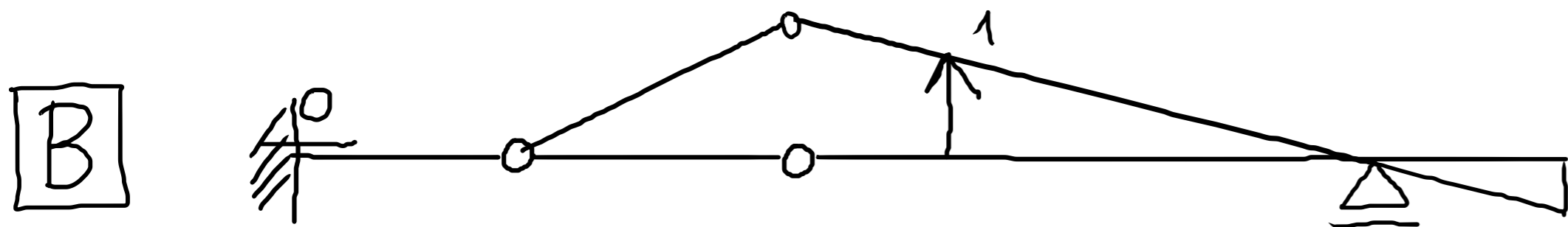
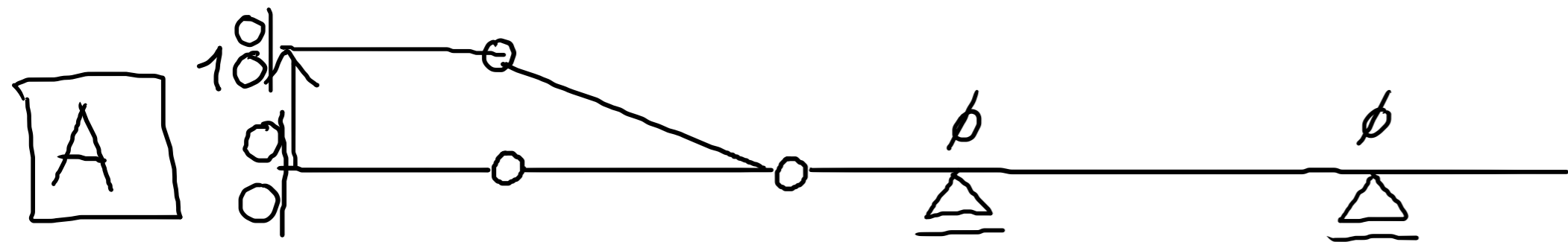
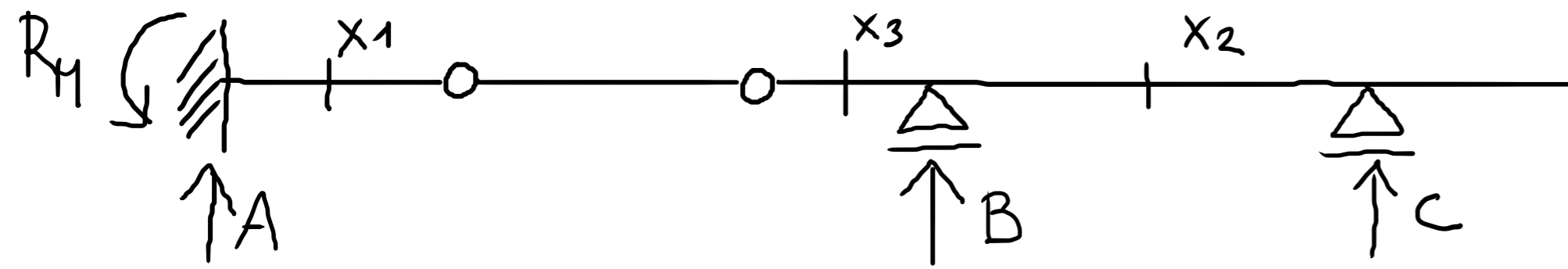

PŘÍČINKOVÉ ČÁRY - GERBERŮV NOSNÍK

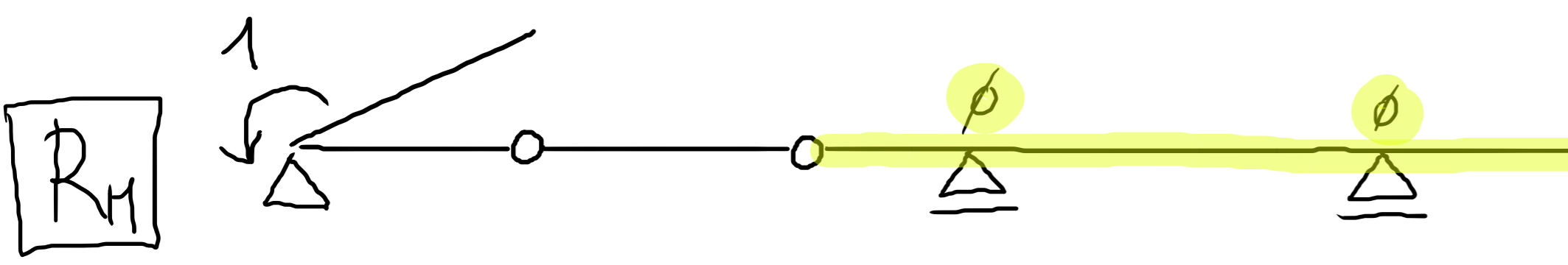
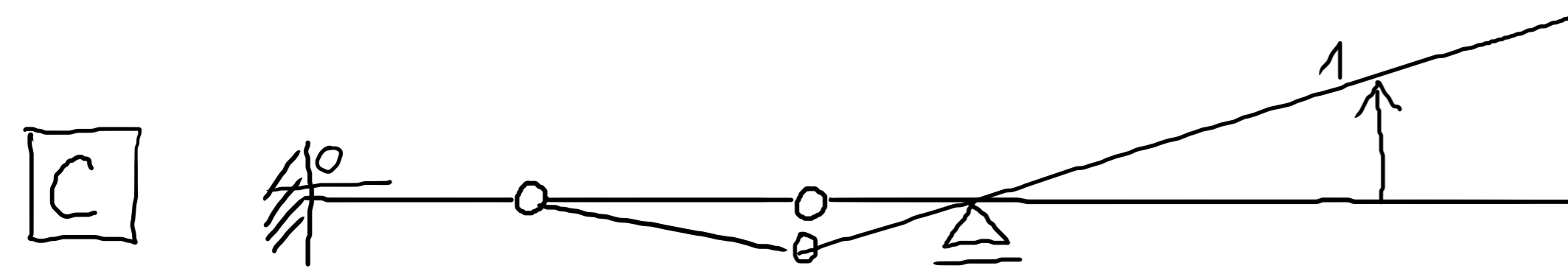
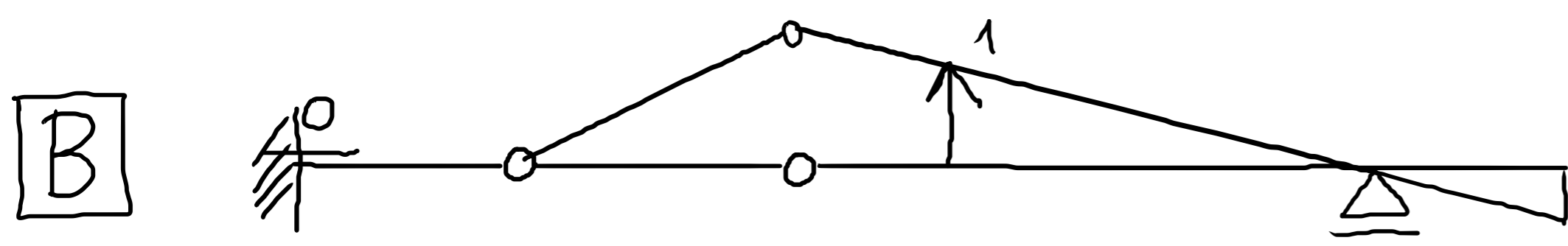
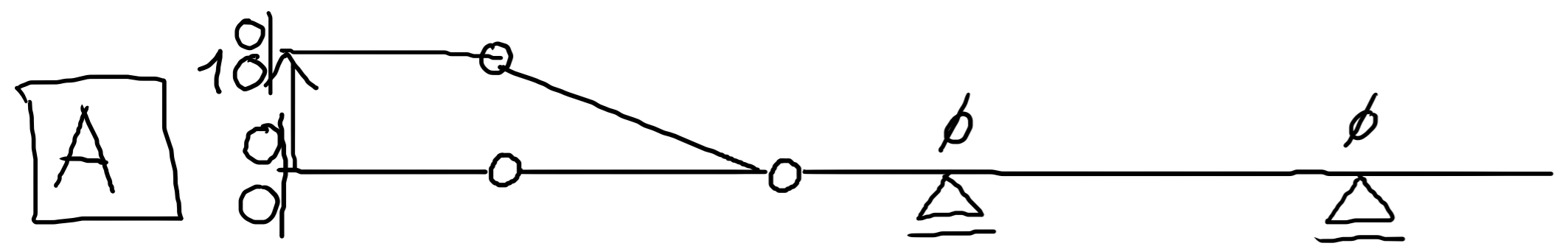
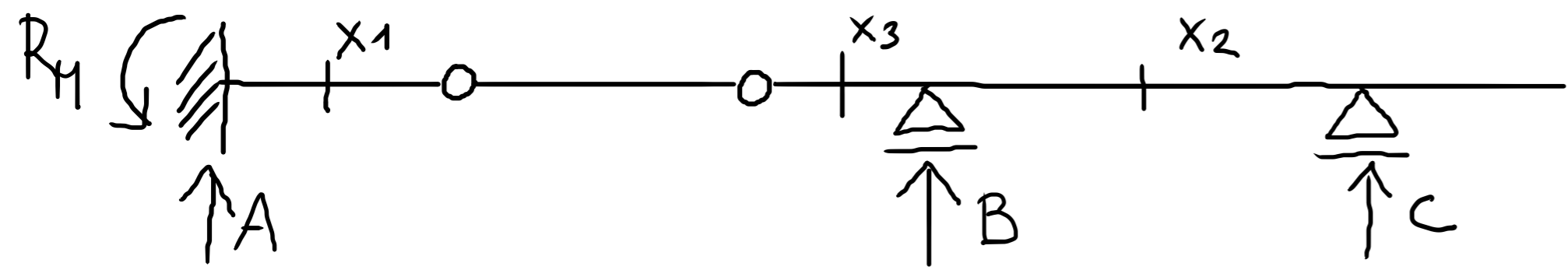

PŘÍČINKOVÉ ČÁRY - GERBERŮV NOSNÍK

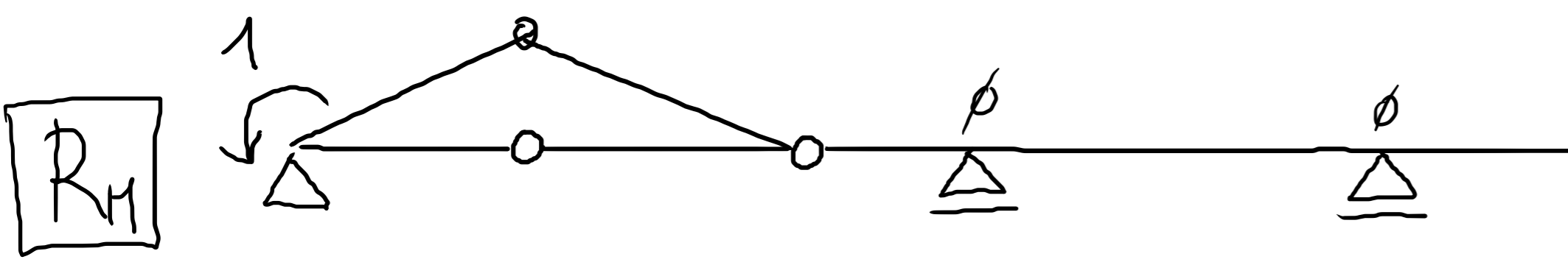
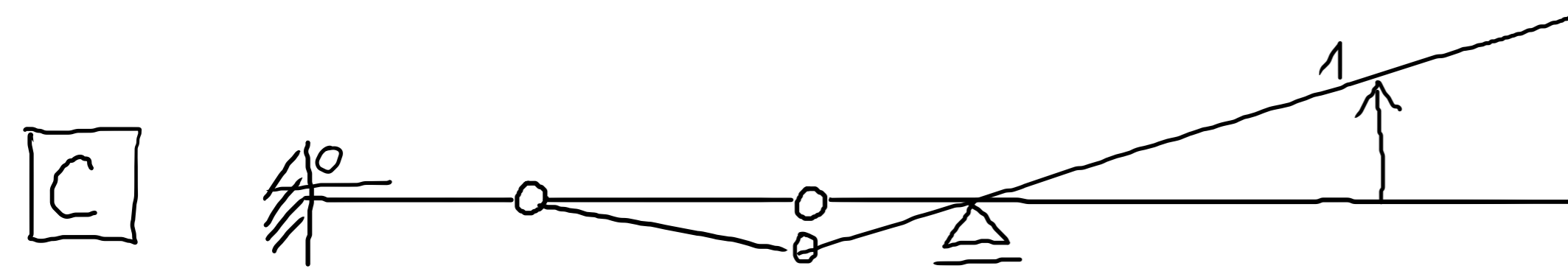
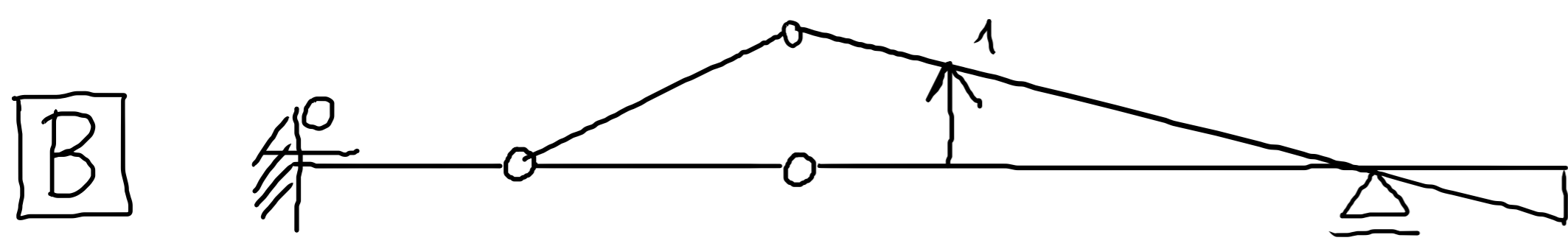
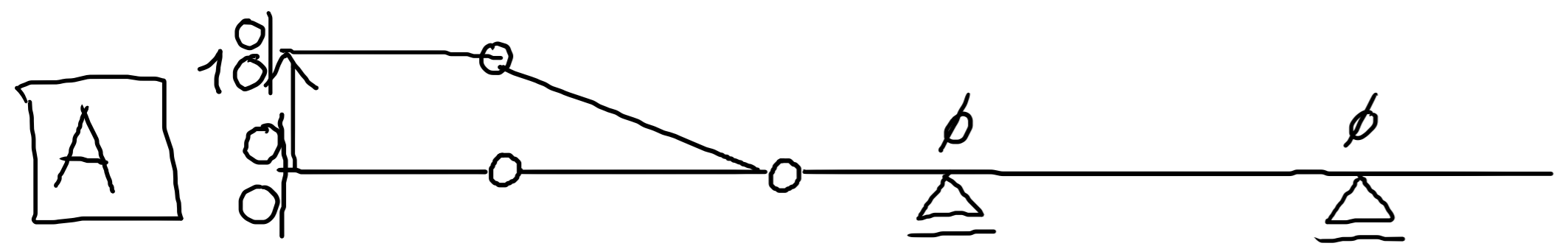
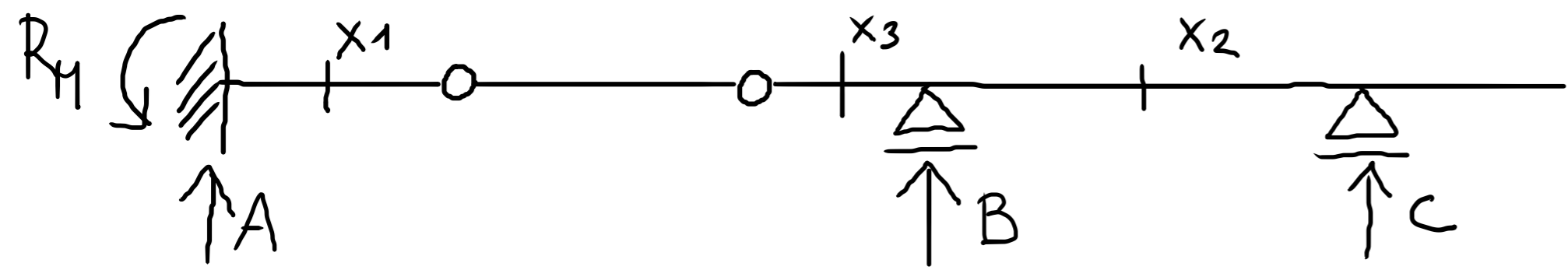

PŘÍČINKOVÉ ČÁRY - GERBERŮV NOSNÍK

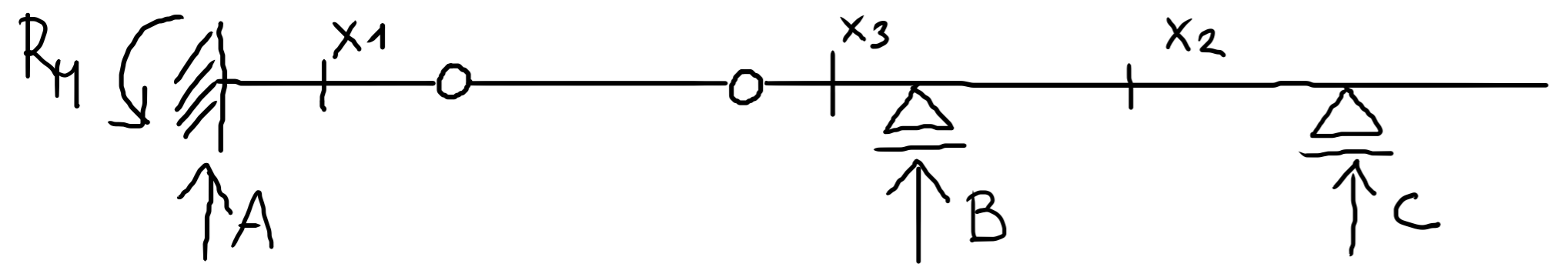

JAK JSME POČÍTALI V.S. NA GERBEROVĚ NOSNÍKU ?

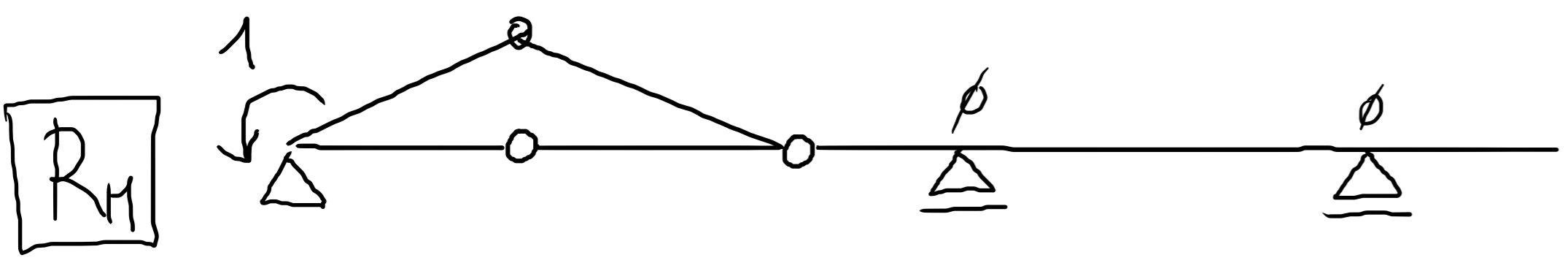
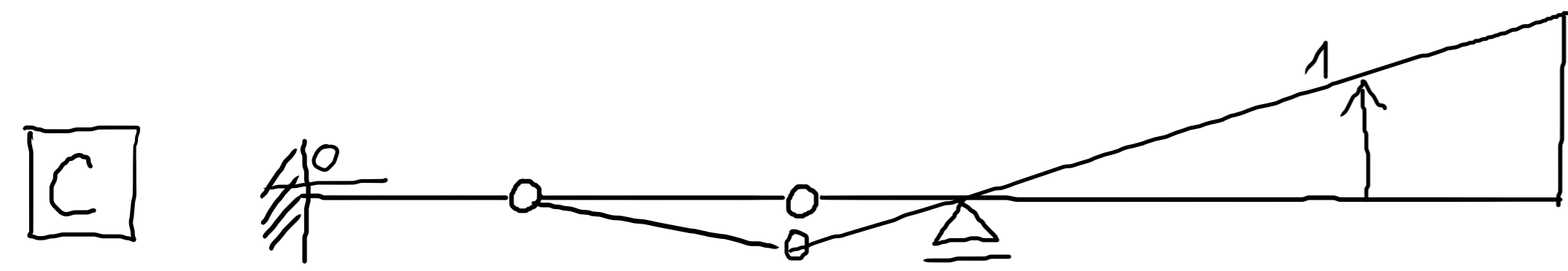
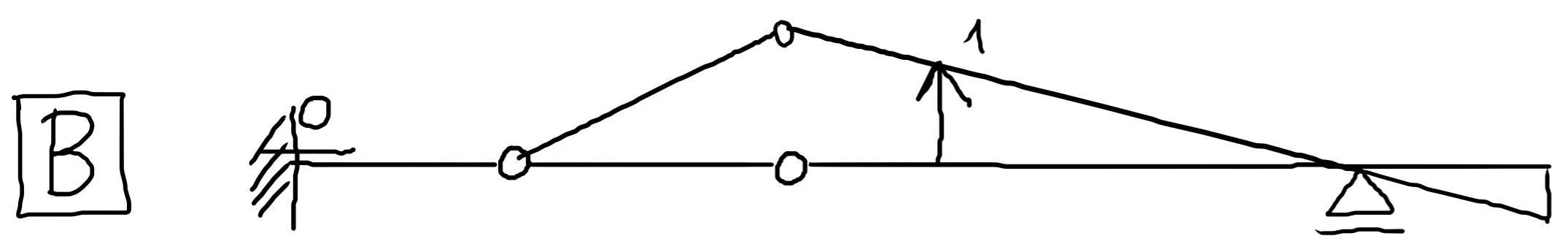
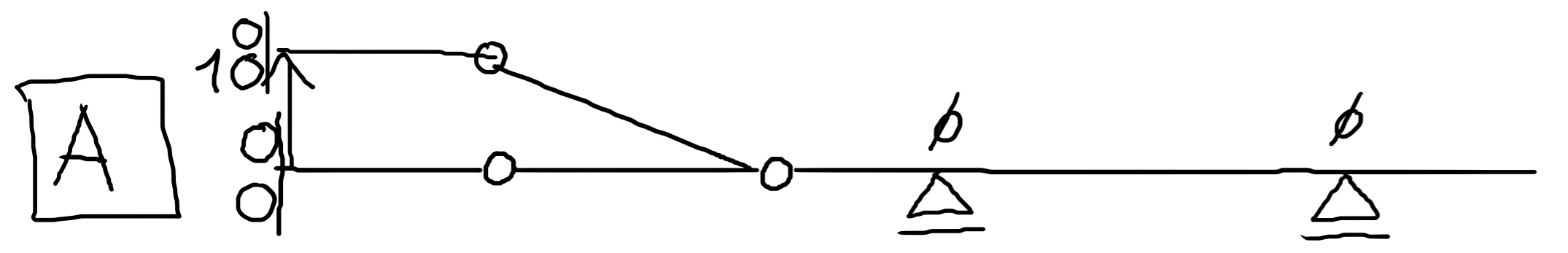

PŘÍČINKOVÉ ČÁRY - GERBERŮV NOSNÍK

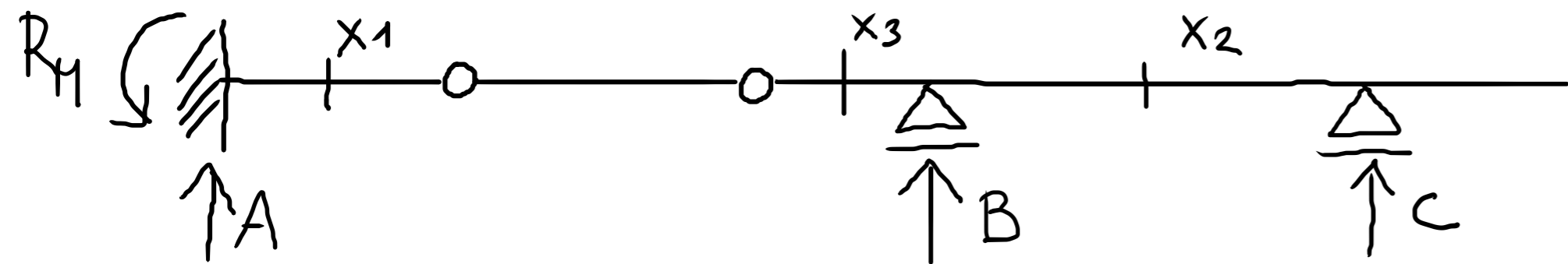

A

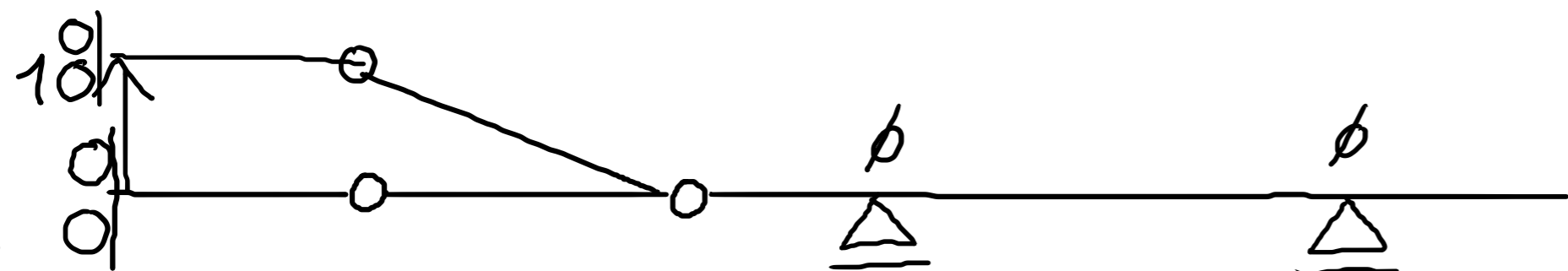

B

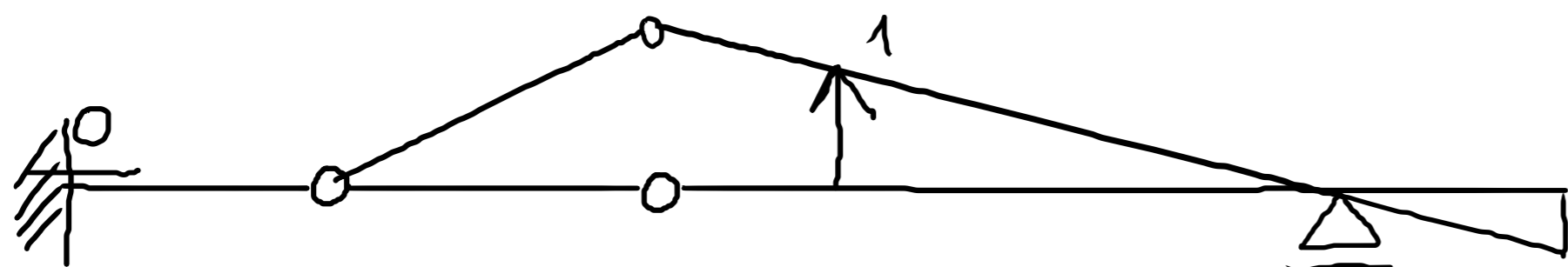

C

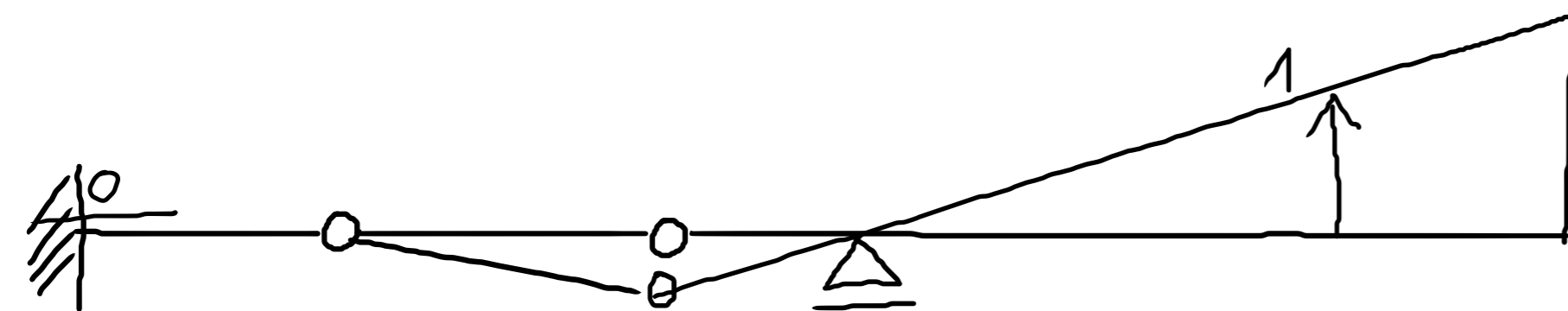

R_H

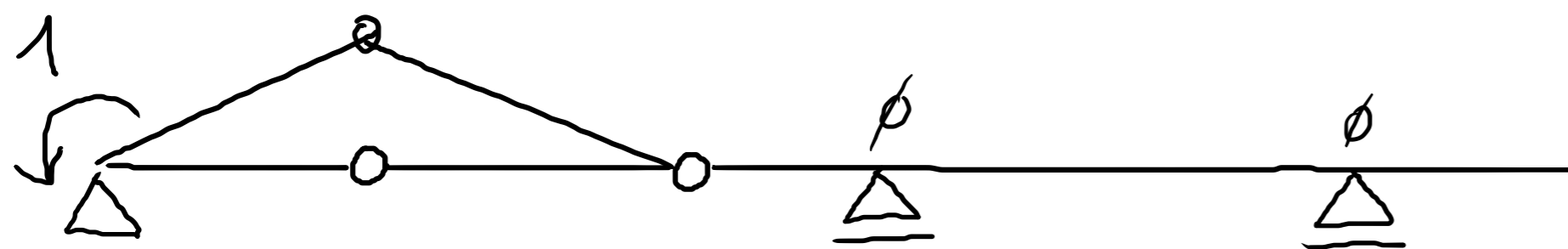

JAK JSME POČÍTALI V.S.
NA GERBEROVĚ NOSNÍKU?

- 1) ROZDĚLIT V KLOUBECH
- 2) USPOŘÁDAT NA NESENE
A NESOUČÍ ČÁSTI

PŘÍČINKOVÉ ČÁRY - GERBERŮV NOSNÍK

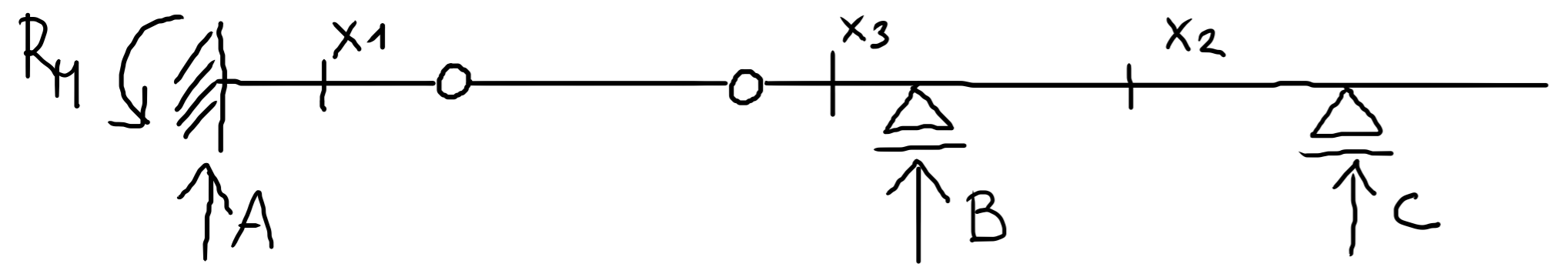

A

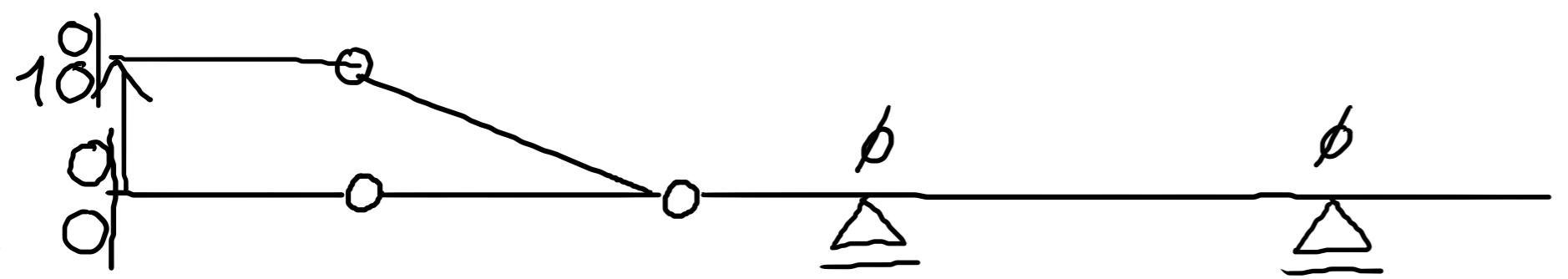

B

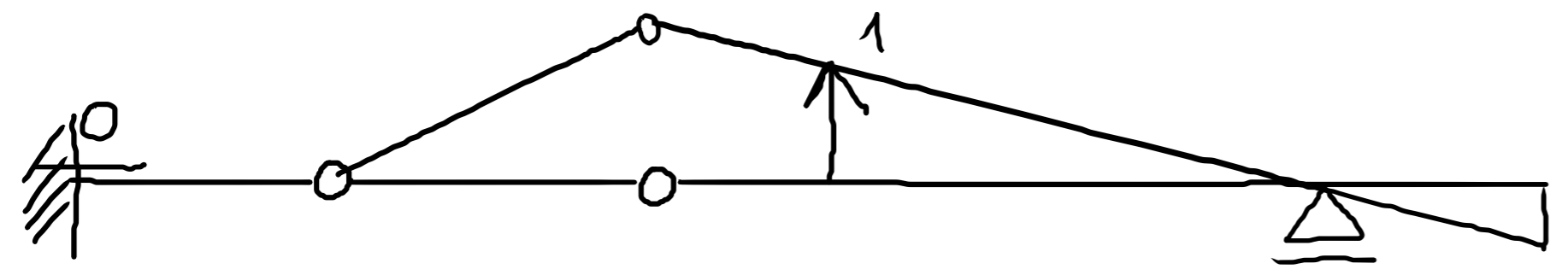

C

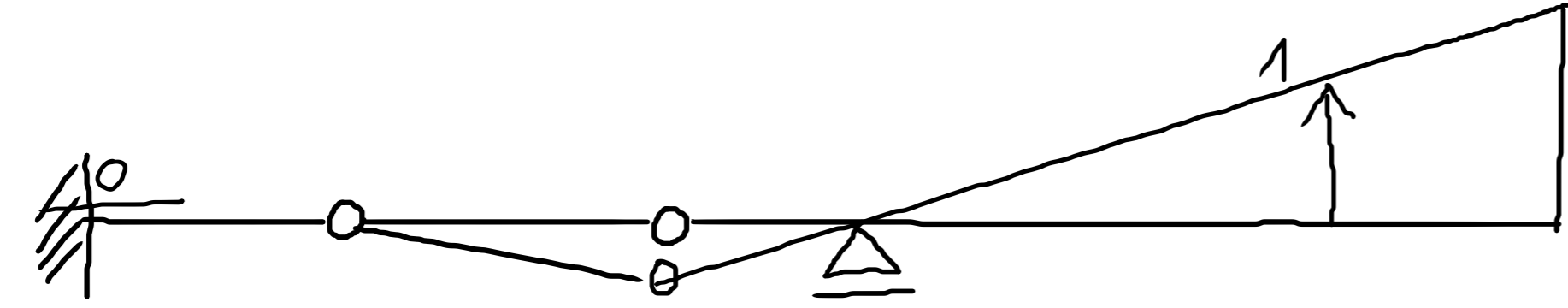

R_H

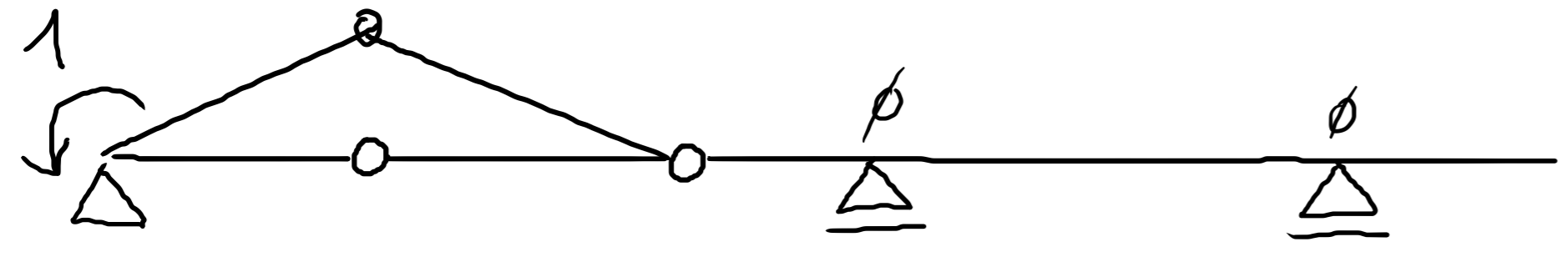

JAK JSME POČÍTALI V.S.
NA GERBEROVĚ NOSNÍKU?

- 1) ROZDĚLIT V KLOUBECH
- 2) USPOŘÁDAT NA NESENE
A NESOUČÍ ČÁSTI

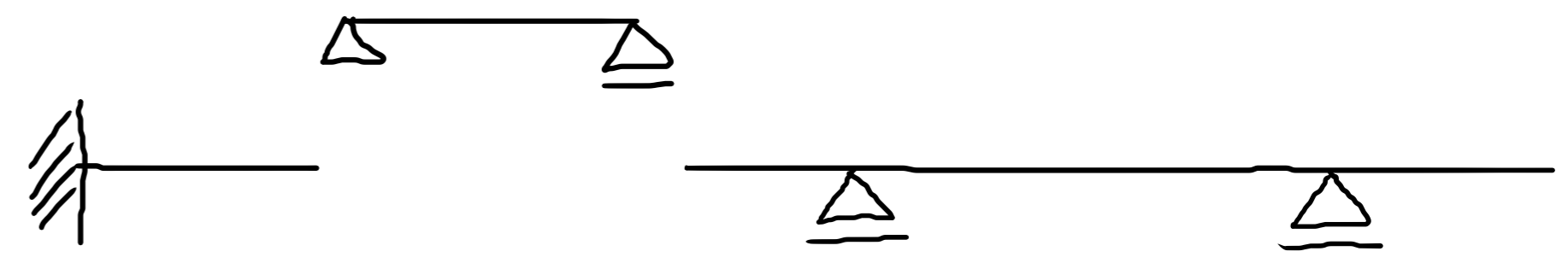

PŘÍČINKOVÉ ČÁRY - GERBERŮV NOSNÍK

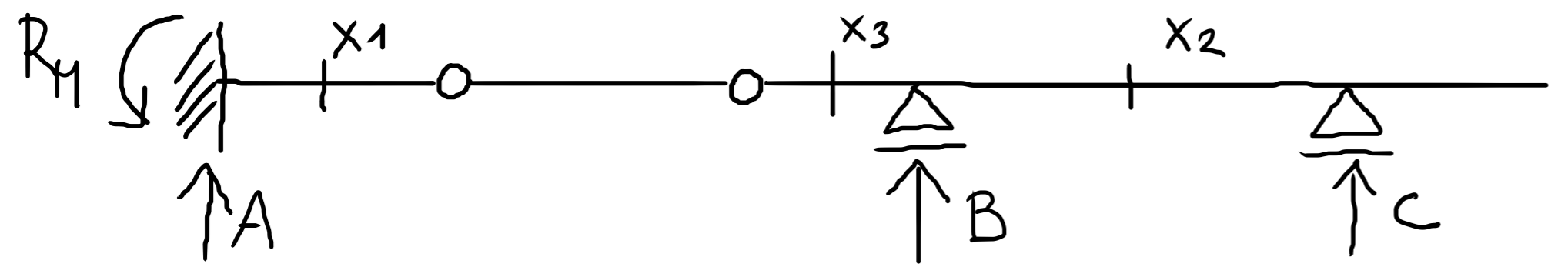

A

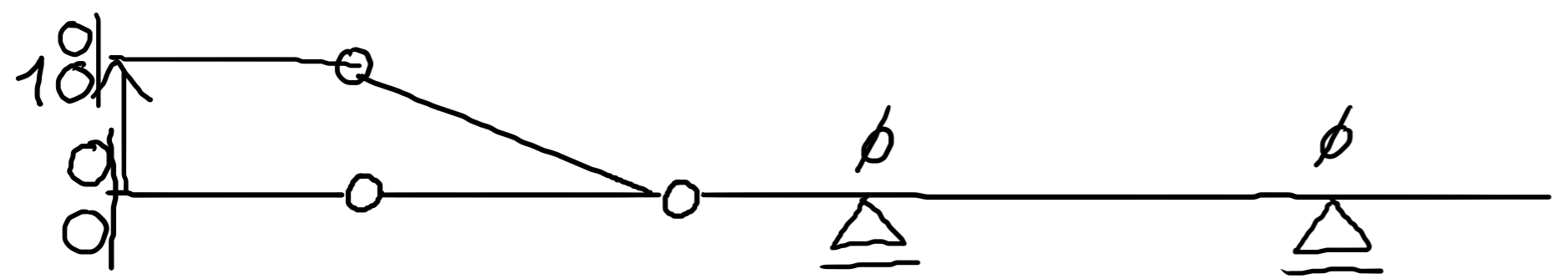

B

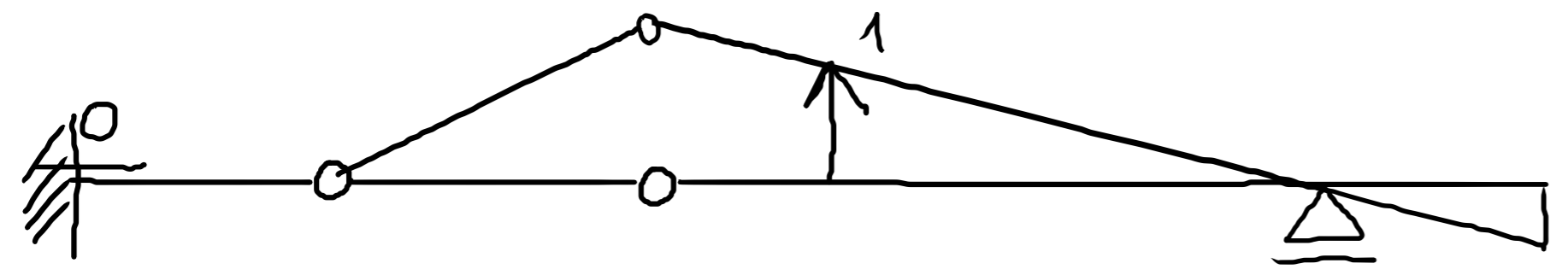

C

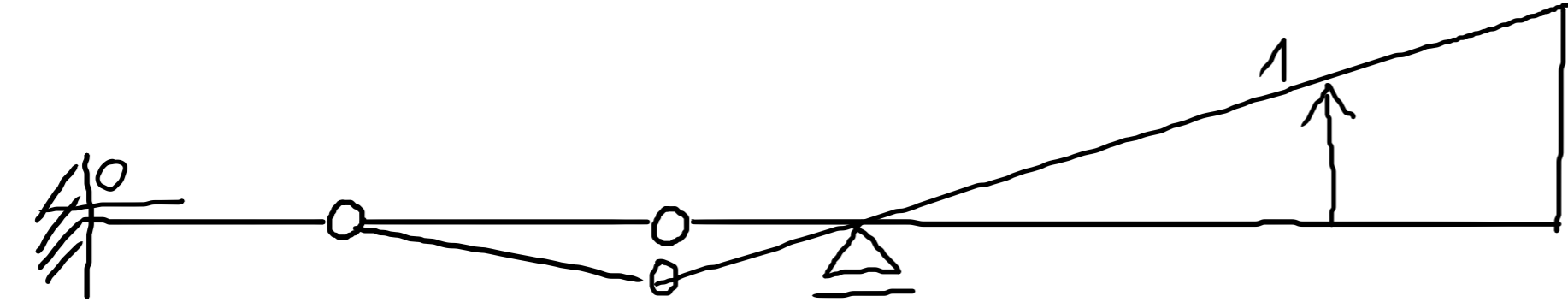

R_H

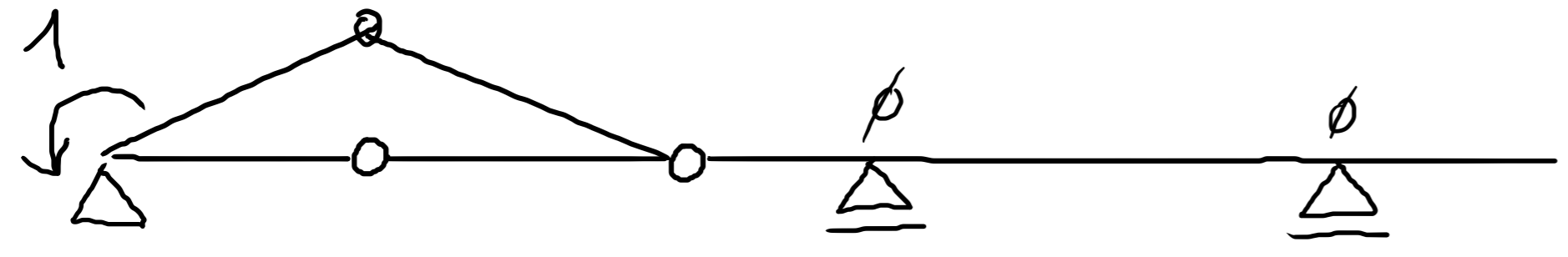

JAK JSME POČÍTALI V.S.
NA GERBEROVĚ NOSNÍKU?

- 1) ROZDĚLIT V KLOUBECH
- 2) USPOŘÁDAT NA NESENE
A NESOUČÍ ČÁSTI

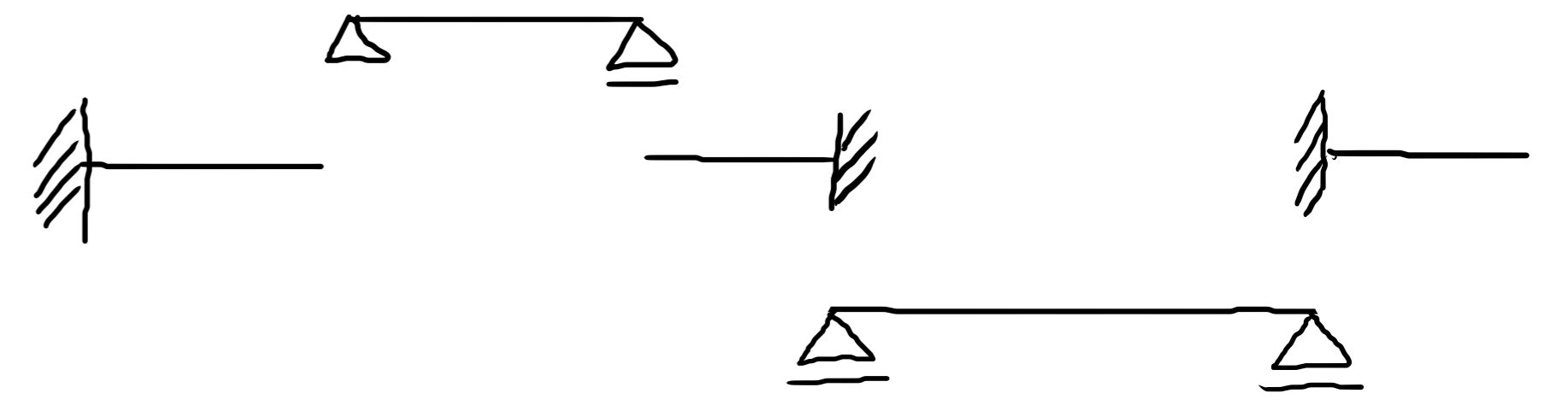
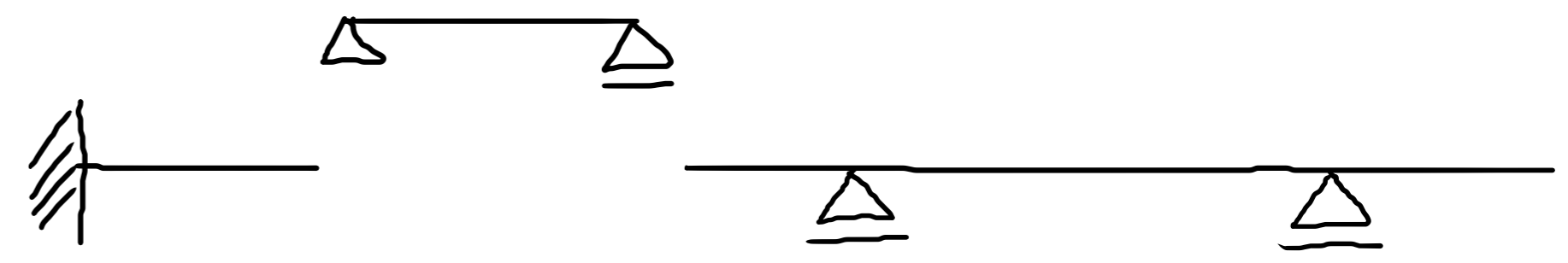

PŘÍČINKOVÉ ČÁRY - GERBERŮV NOSNÍK

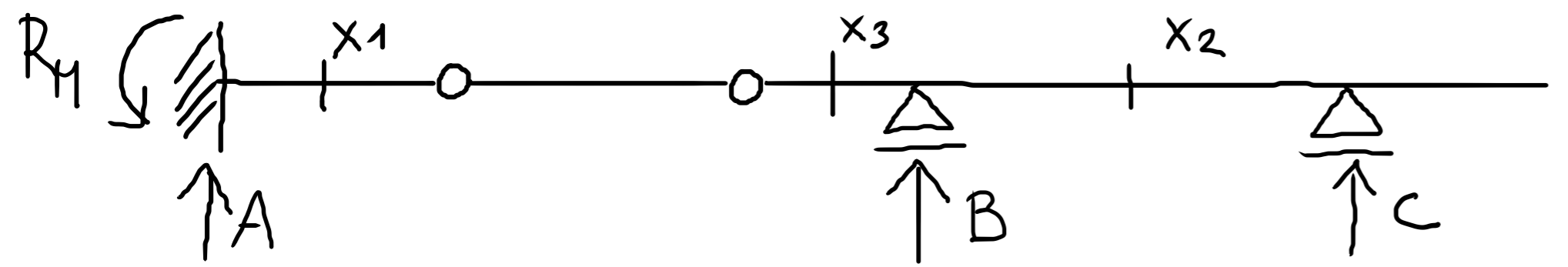

A

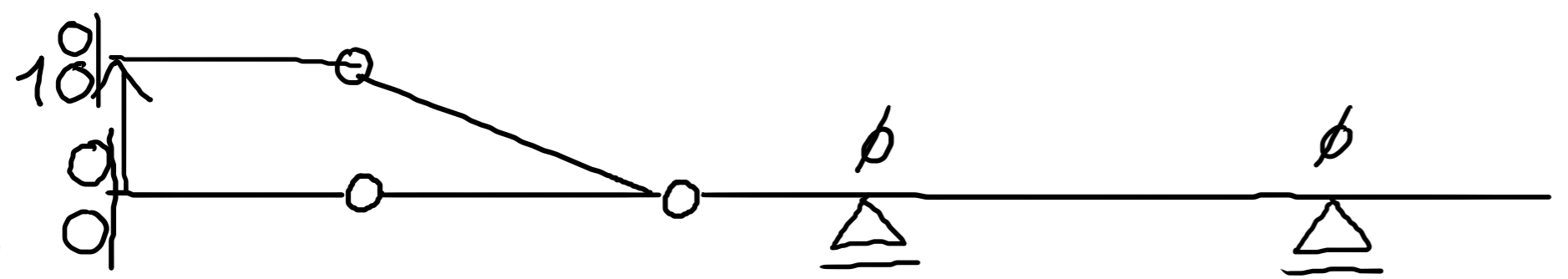

B

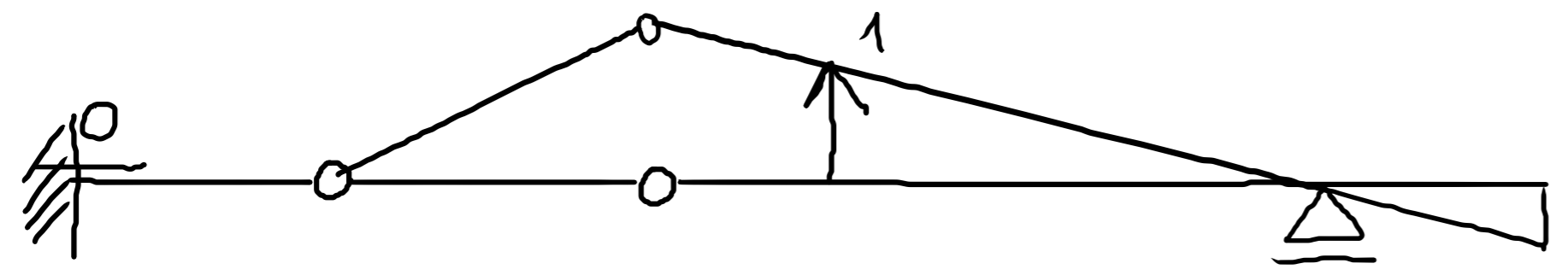

C

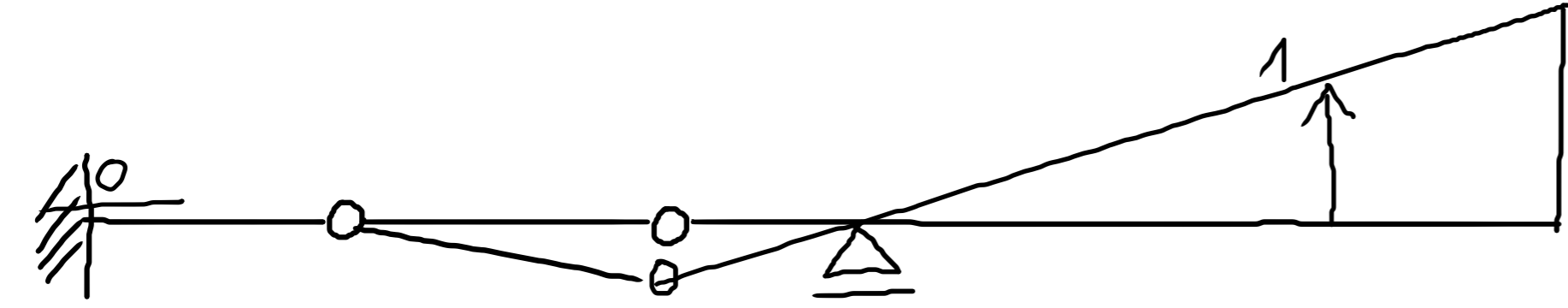

R_H

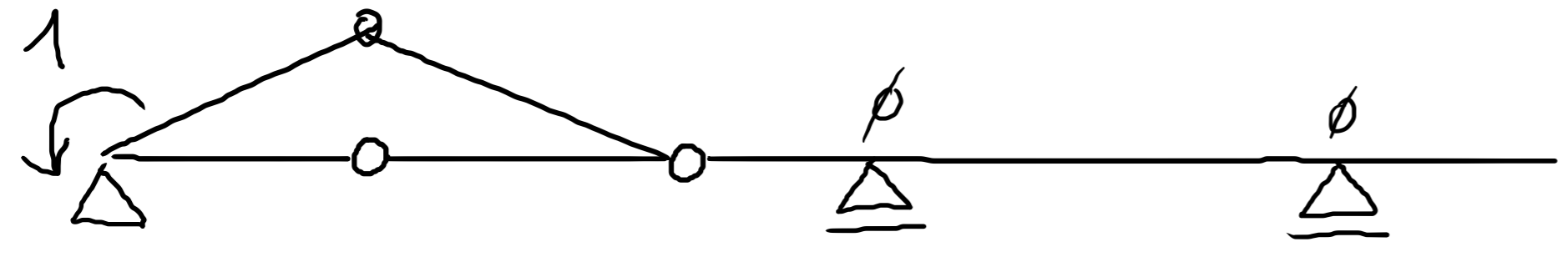

JAK JSME POČÍTALI V.S.
NA GERBEROVĚ NOSNÍKU?

- 1) ROZDĚLIT V KLOUBECH
- 2) USPOŘÁDAT NA NESENE
A NESOUČÍ ČÁSTI

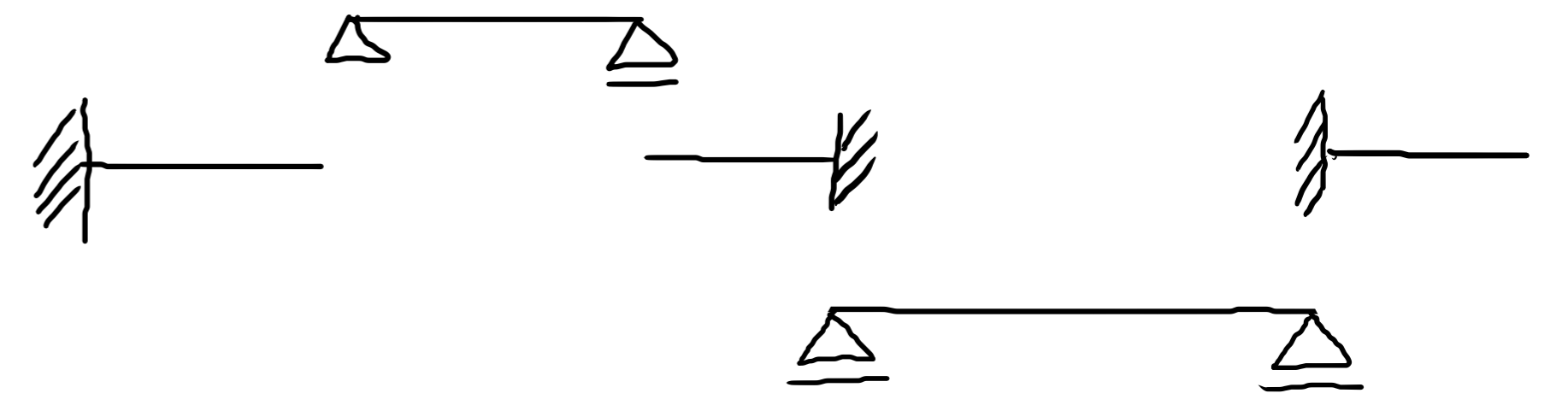
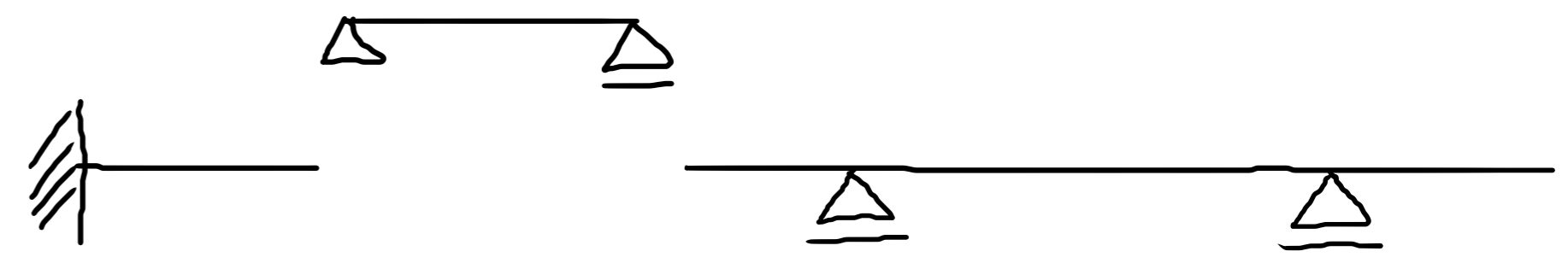

PŘÍČINKOVÉ ČÁRY - GERBERŮV NOSNÍK

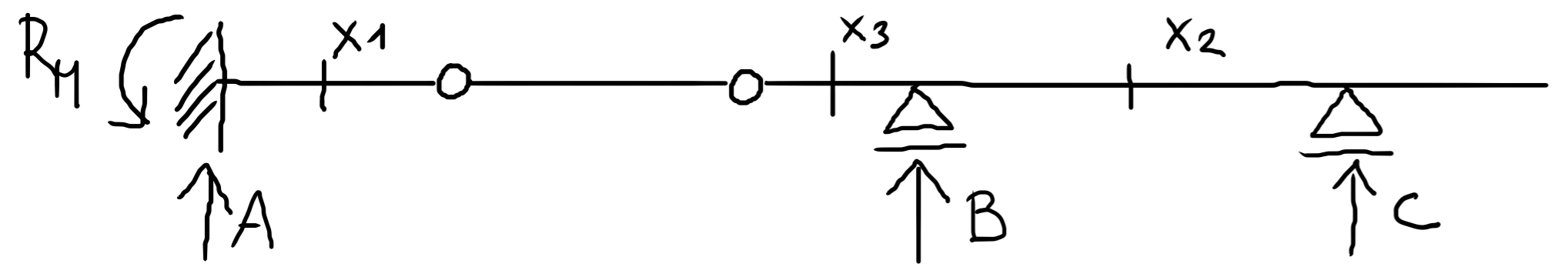

A

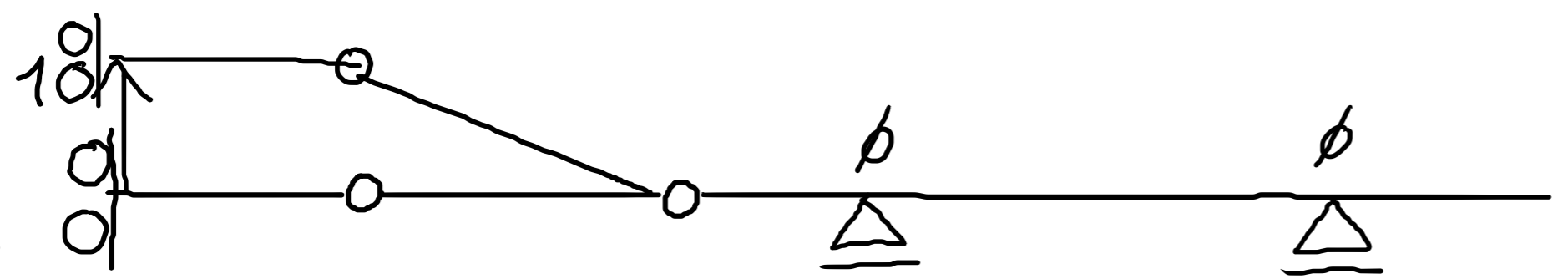

B

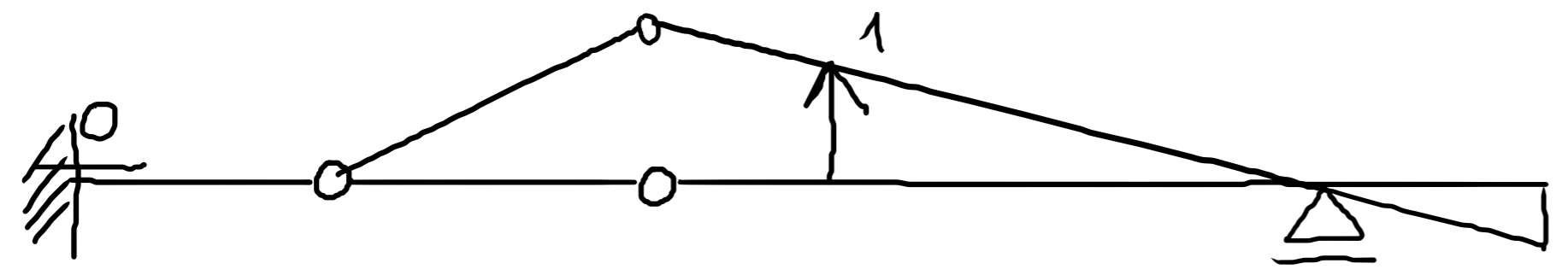

C

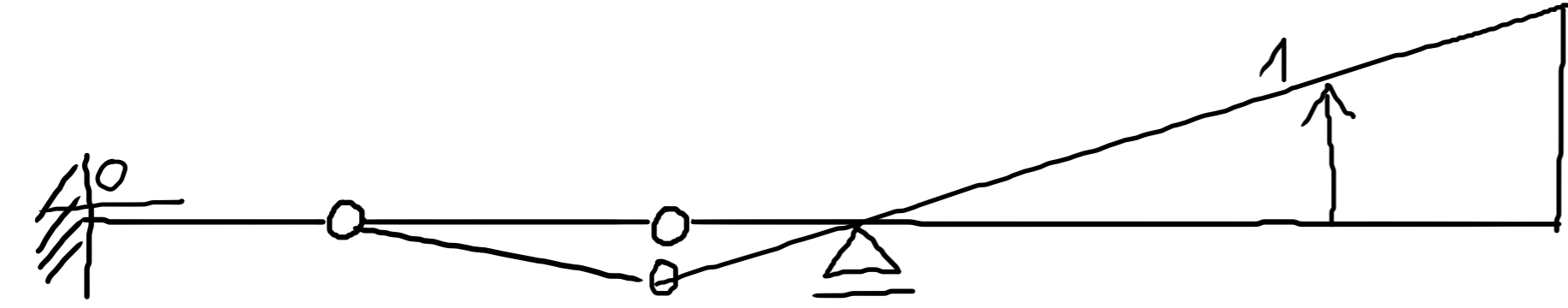

RA

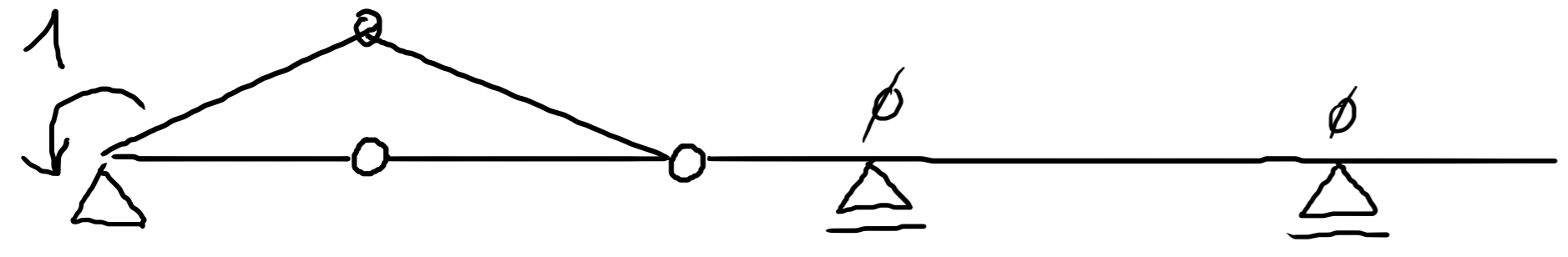

JAK JSME POČÍTALI V.S.
NA GERBEROVĚ NOSNÍKU?

- 1) ROZDĚLIT V KLOUBECH
- 2) USPOŘÁDAT NA NESENE
A NESOUČÍ ČÁSTI

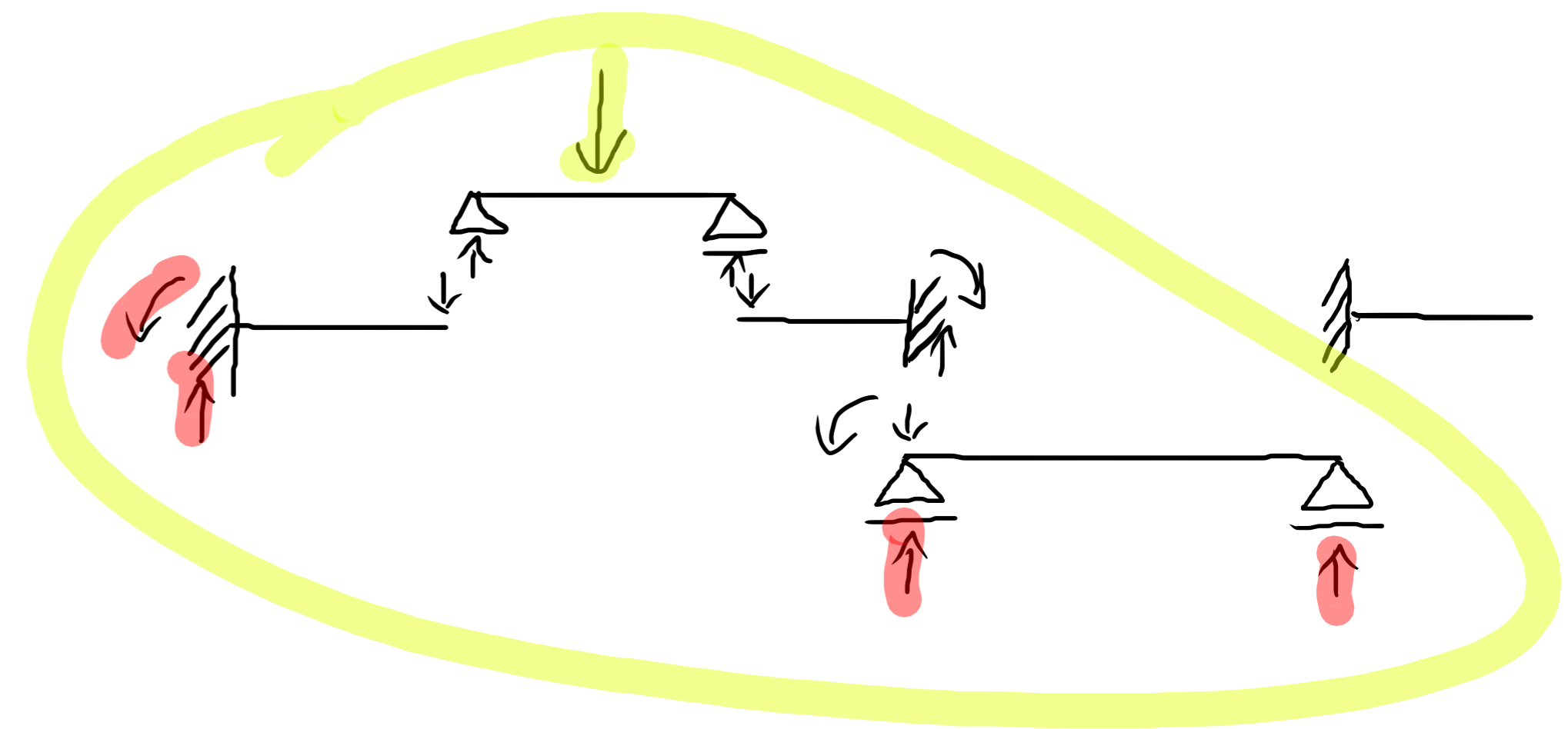
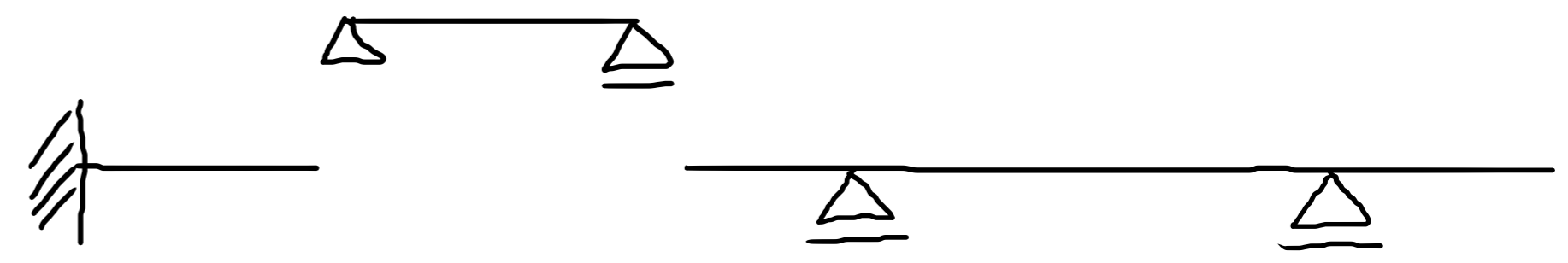

PŘÍČINKOVÉ ČÁRY - GERBERŮV NOSNÍK

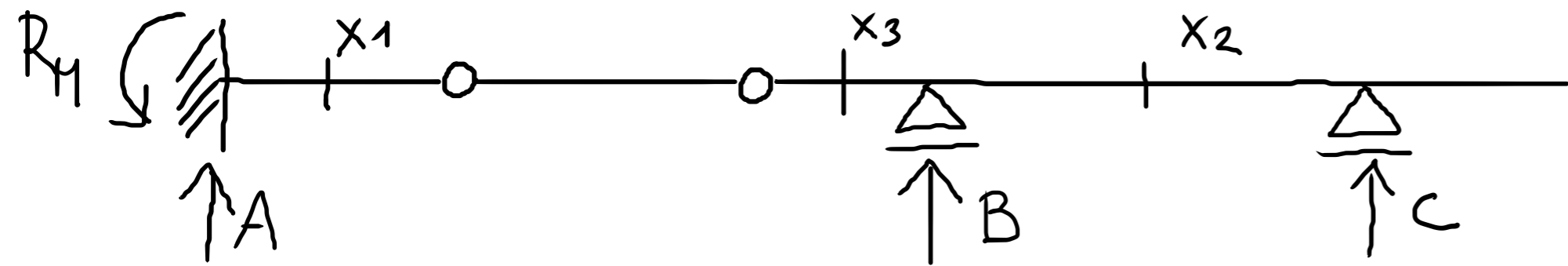

A

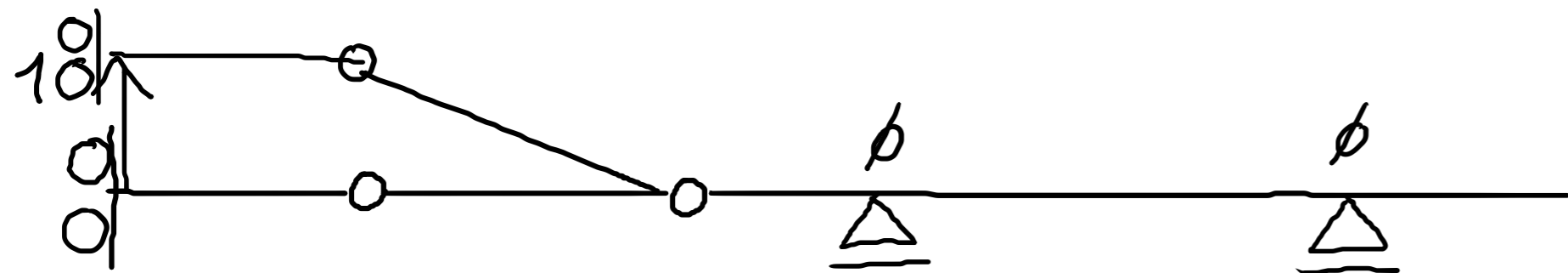

B

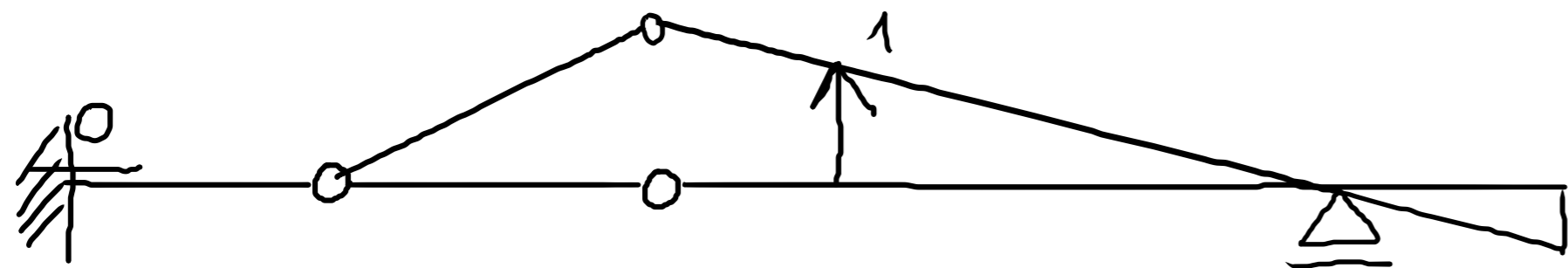

C

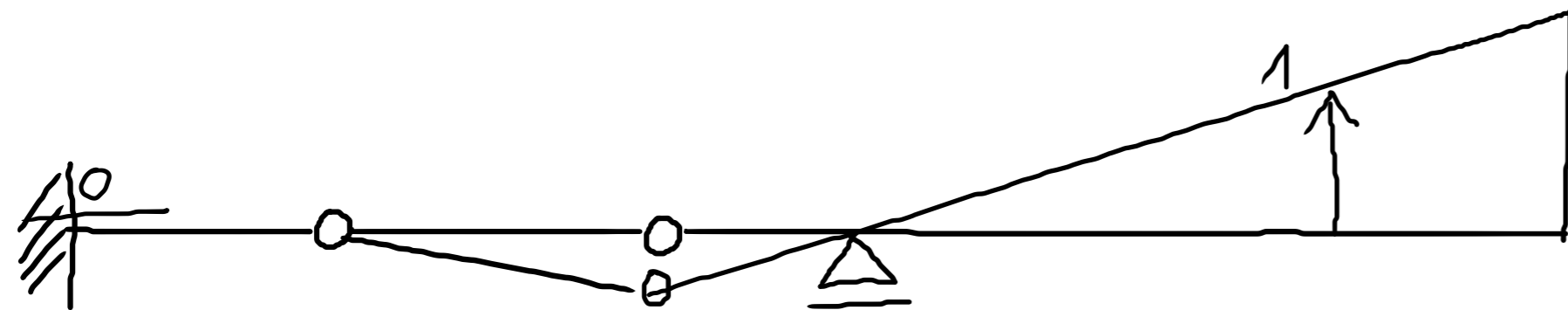

D

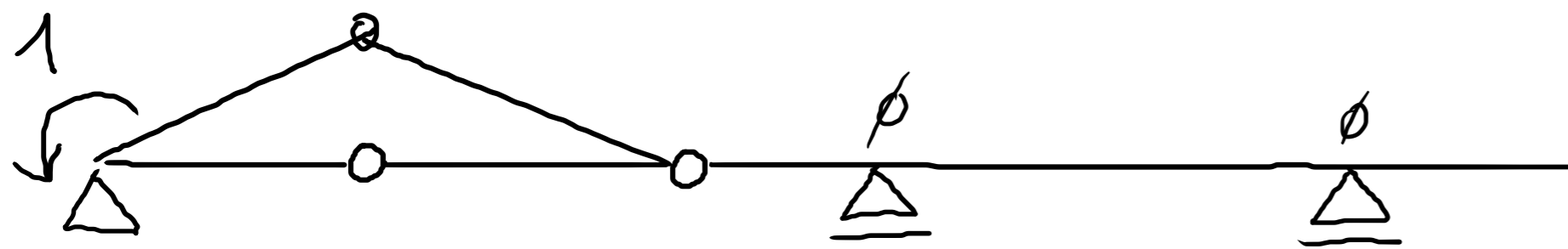

JAK JSME POČÍTALI V.S.
NA GERBEROVĚ NOSNÍKU?

- 1) ROZDĚLIT V KLOUBECH
- 2) USPOŘÁDAT NA NESENEJÍ
A NESOUČÍ ČÁSTI

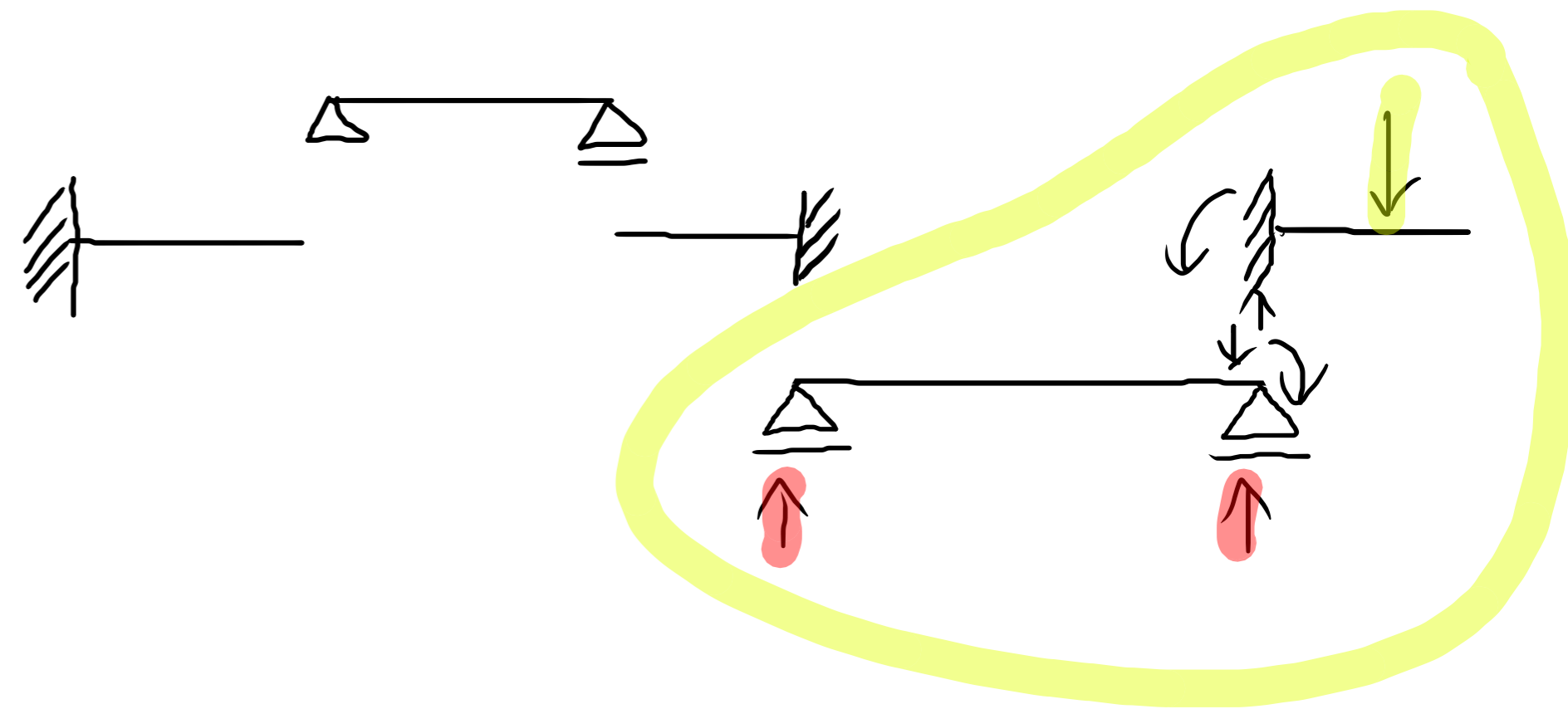
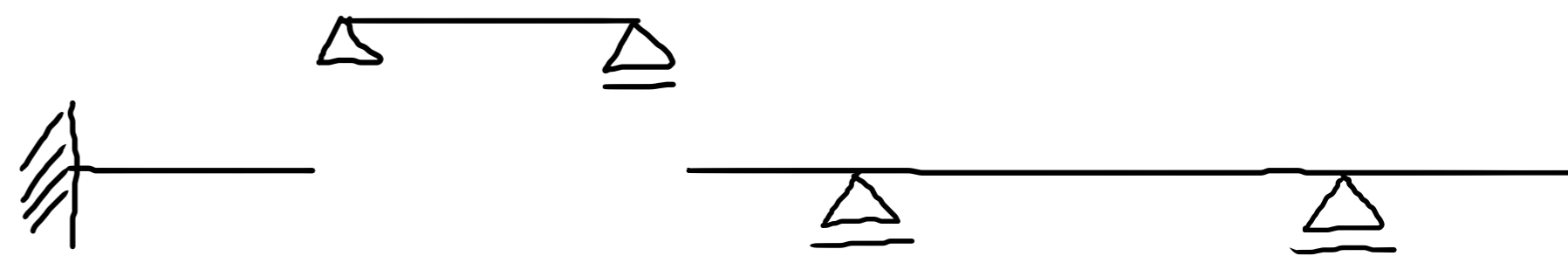

PŘÍČINKOVÉ ČÁRY - GERBERŮV NOSNÍK

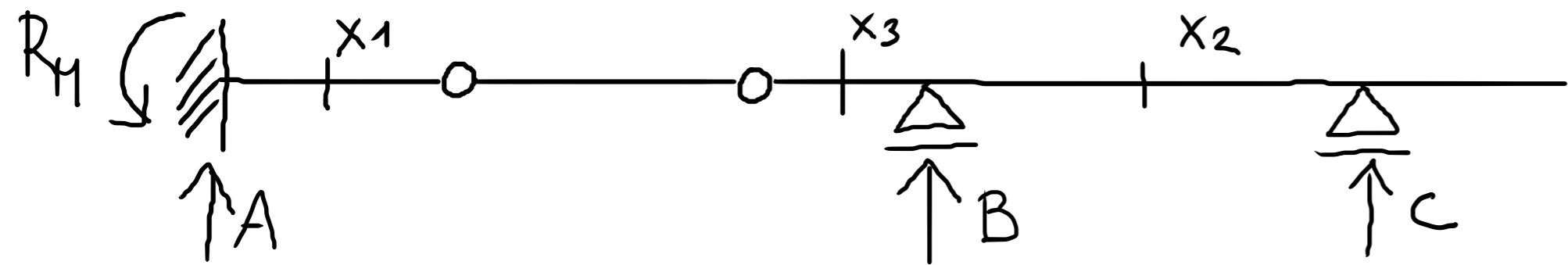

A

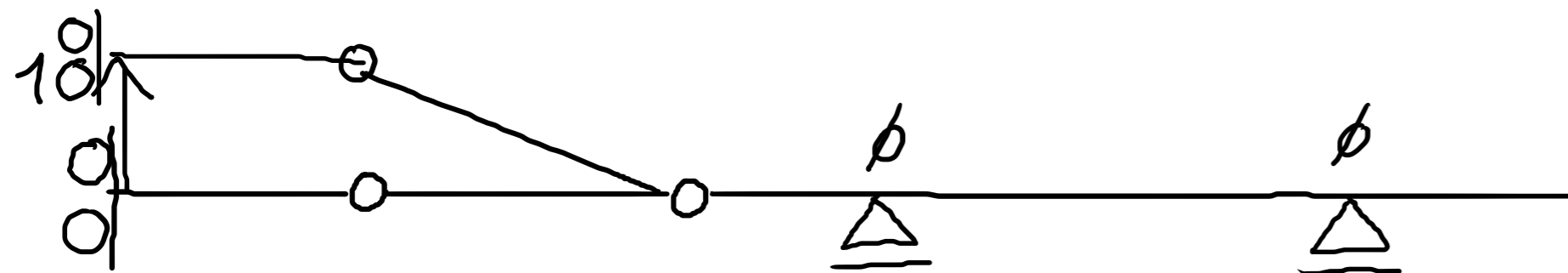

B

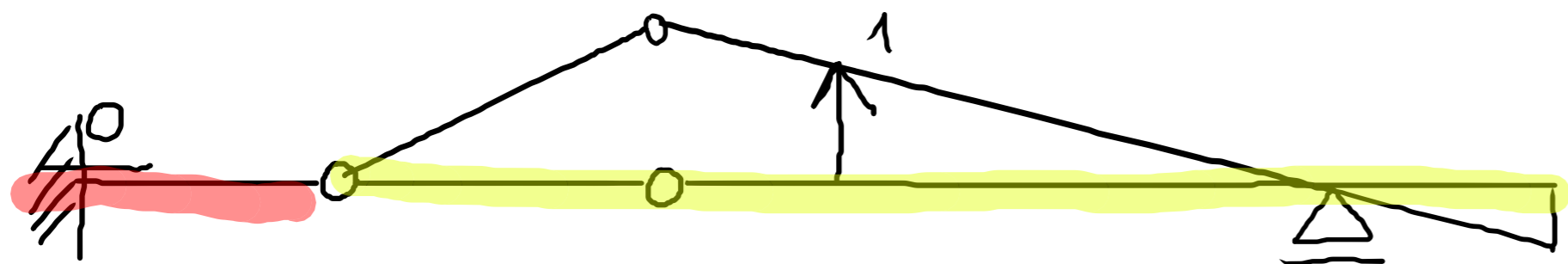

C

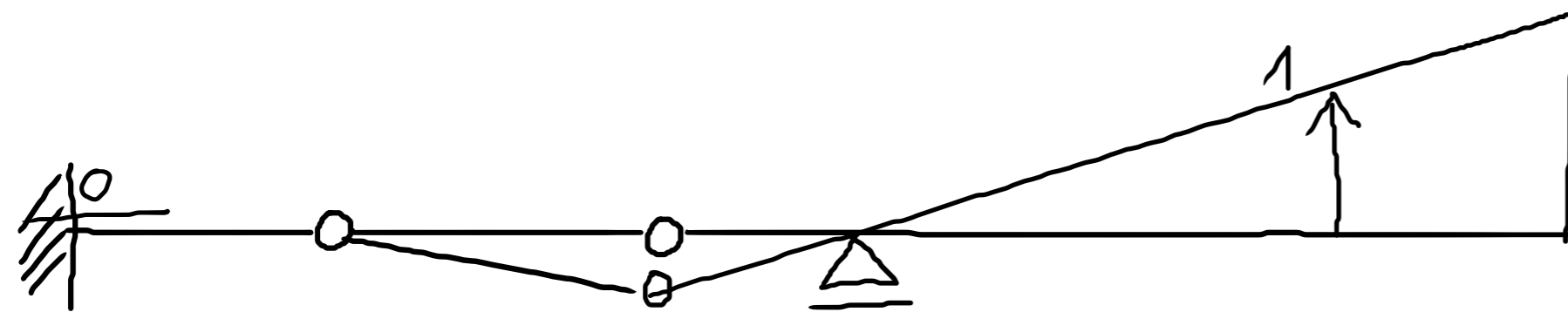

D

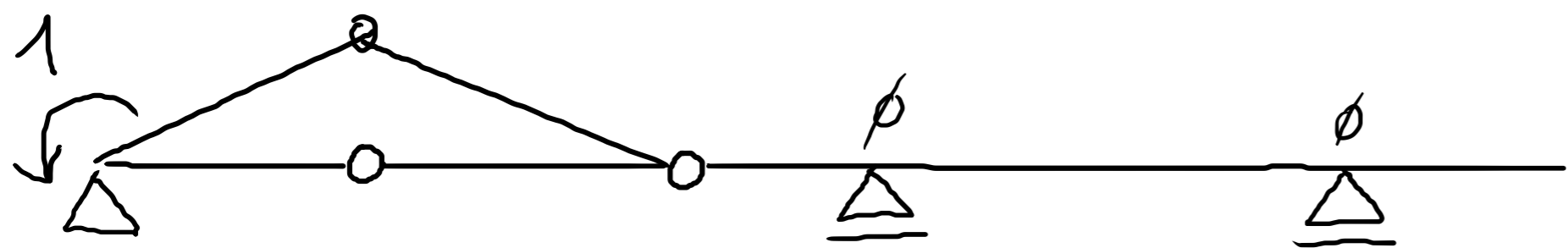

JAK JSME POČÍTALI V.S.
NA GERBEROVĚ NOSNÍKU ?

- 1) ROZDĚLIT V KLOUBECH
- 2) USPOŘÁDAT NA NESENE
A NESOUČÍ ČÁSTI

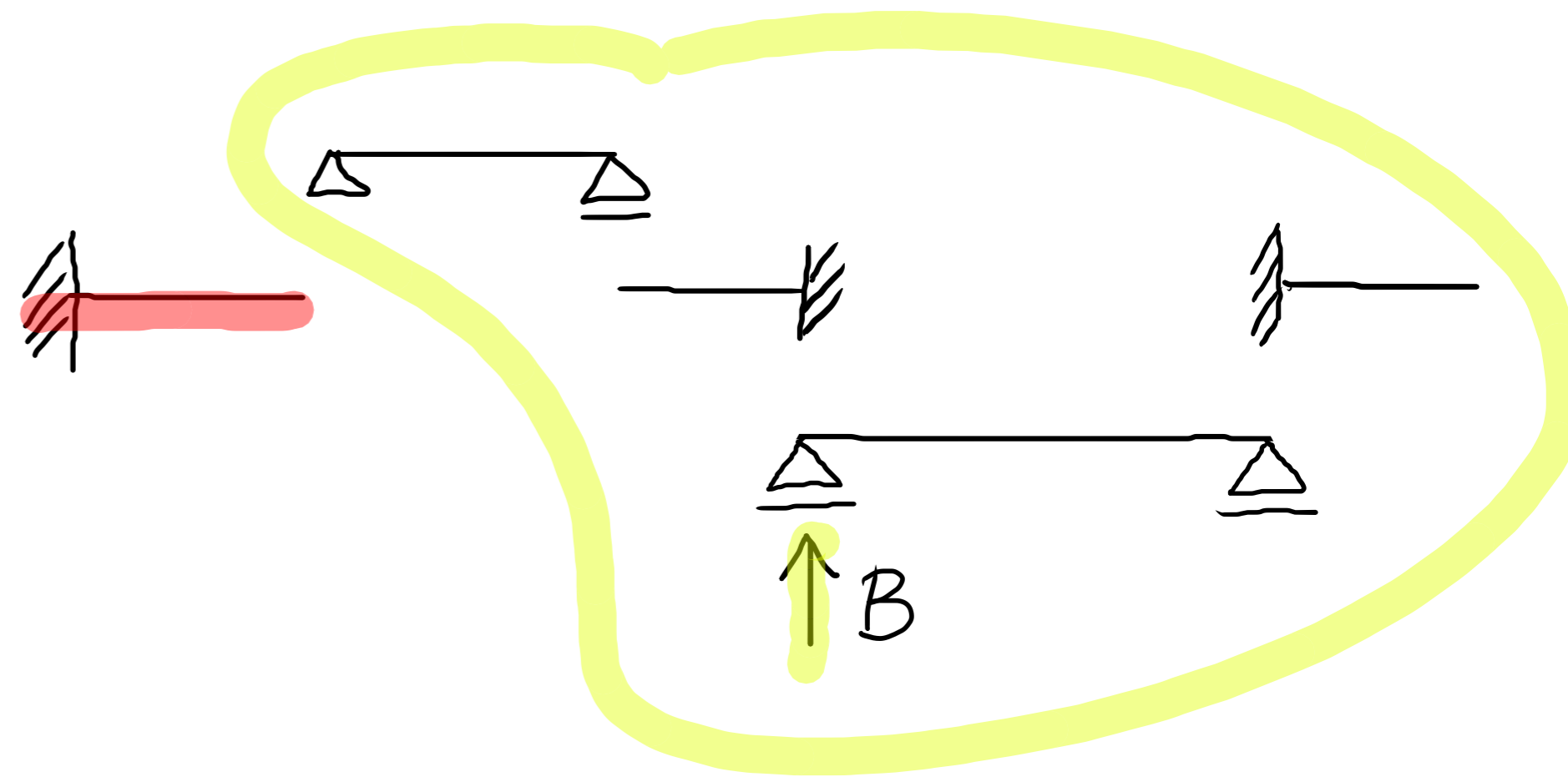
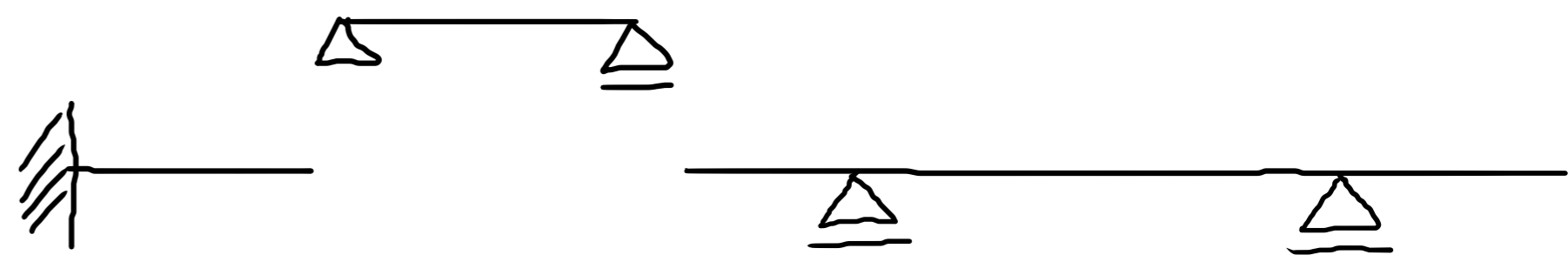

PŘÍČINKOVÉ ČÁRY - GERBERŮV NOSNÍK

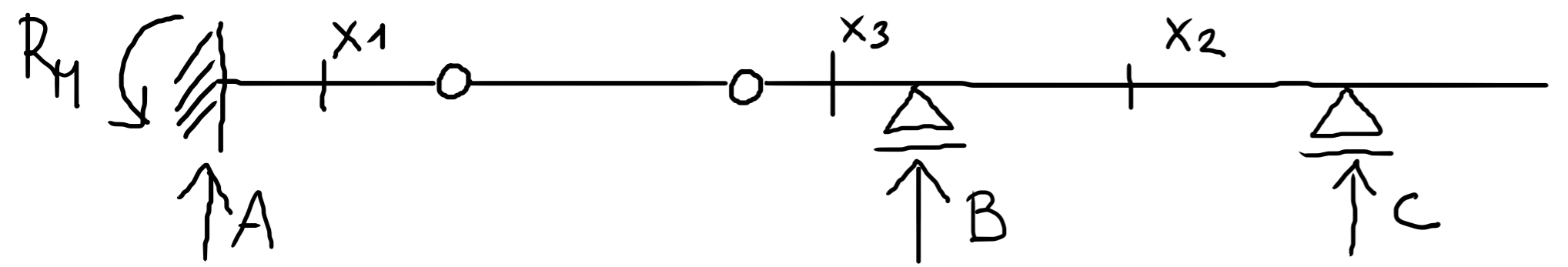

A

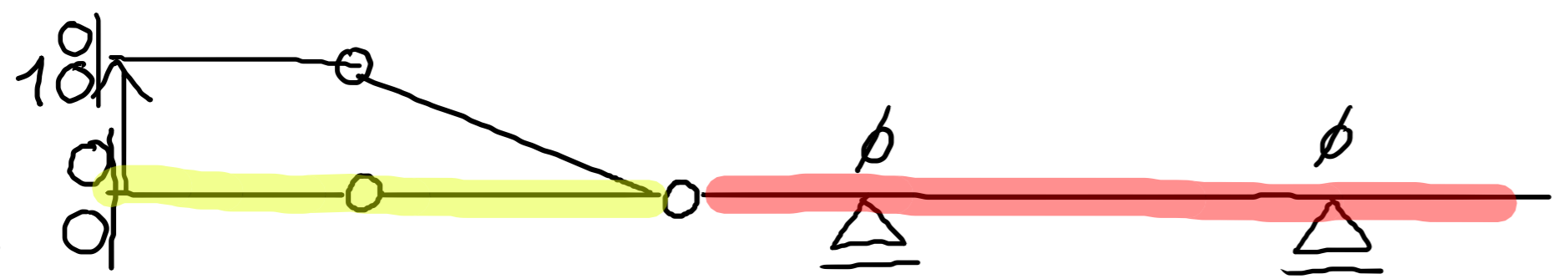

B

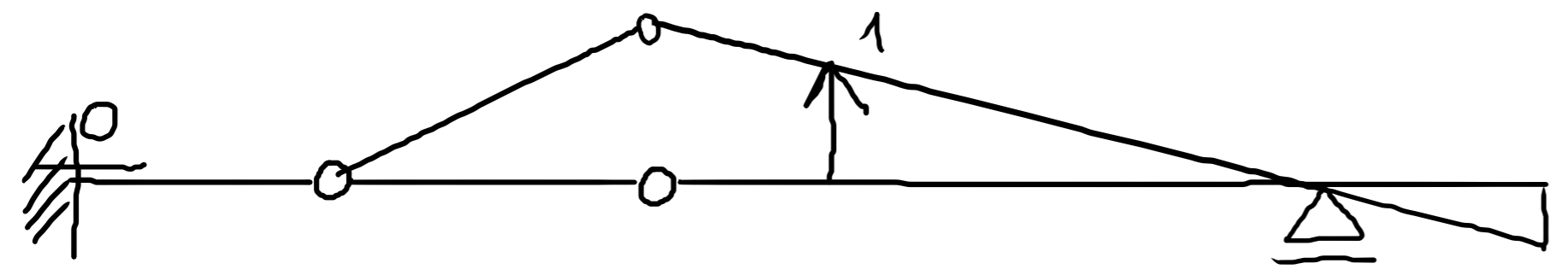

C

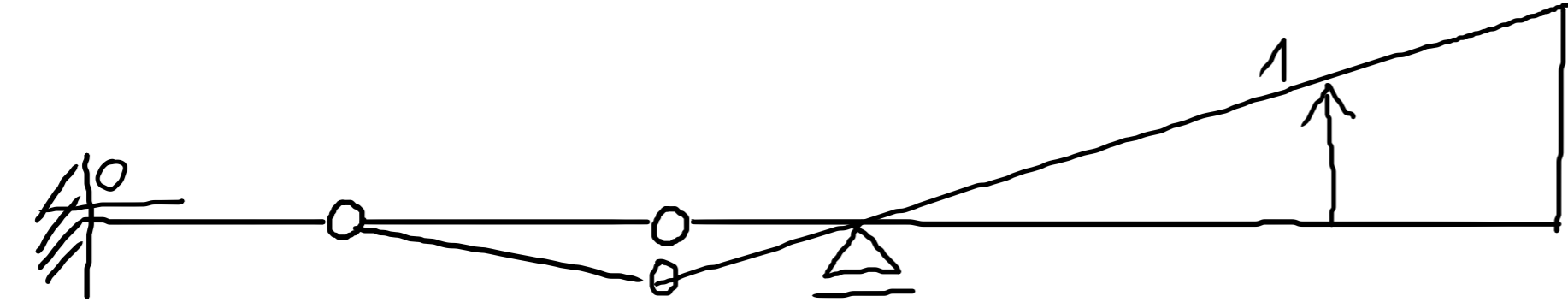

R_H

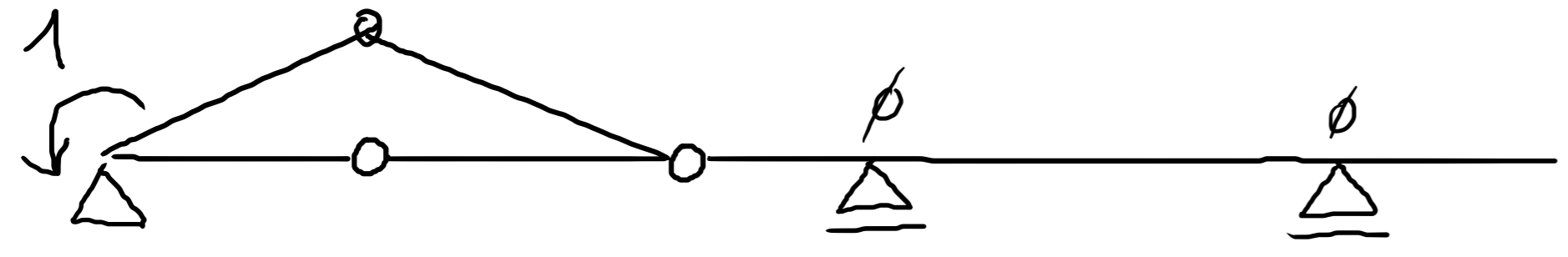

JAK JSME POČÍTALI V.S.
NA GERBEROVĚ NOSNÍKU?

- 1) ROZDĚLIT V KHOUBECH
- 2) USPOŘÁDAT NA NESENE
A NESOUČÍ ČÁSTI

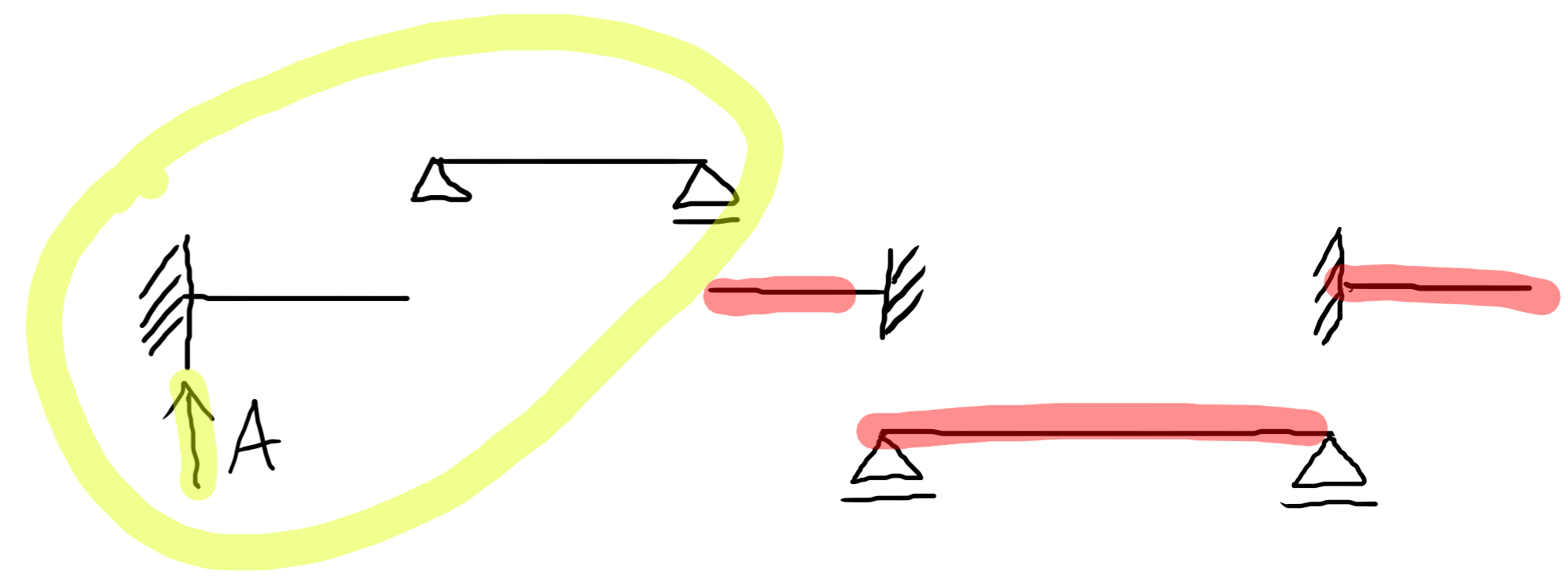
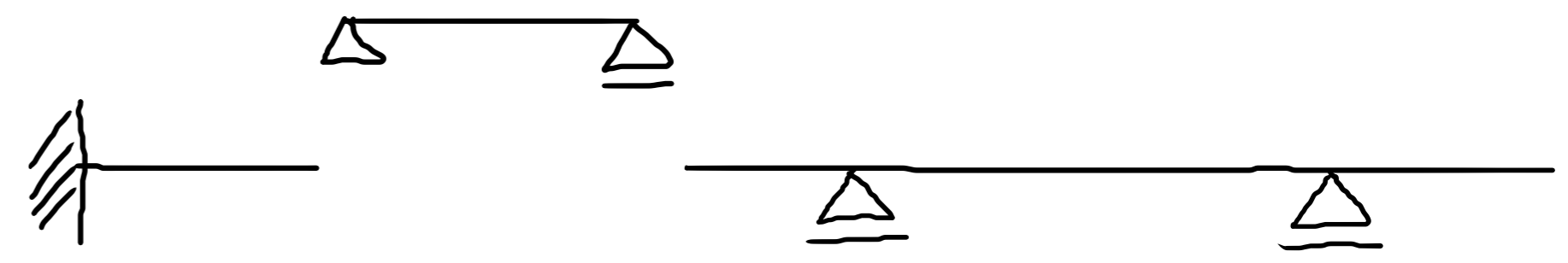

PŘÍČINKOVÉ ČÁRY - GERBERŮV NOSNÍK

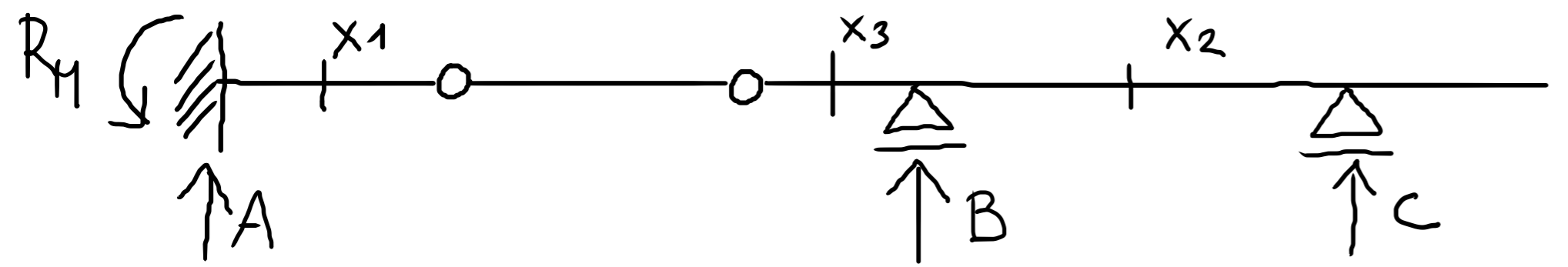

A

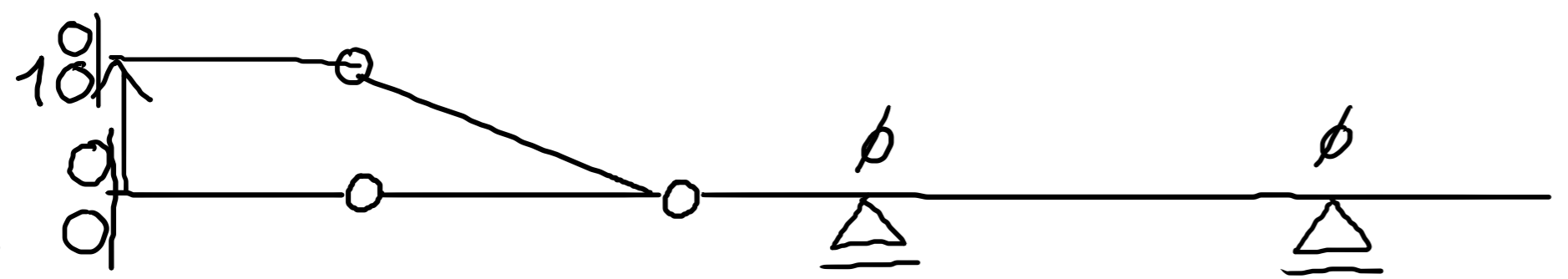

B

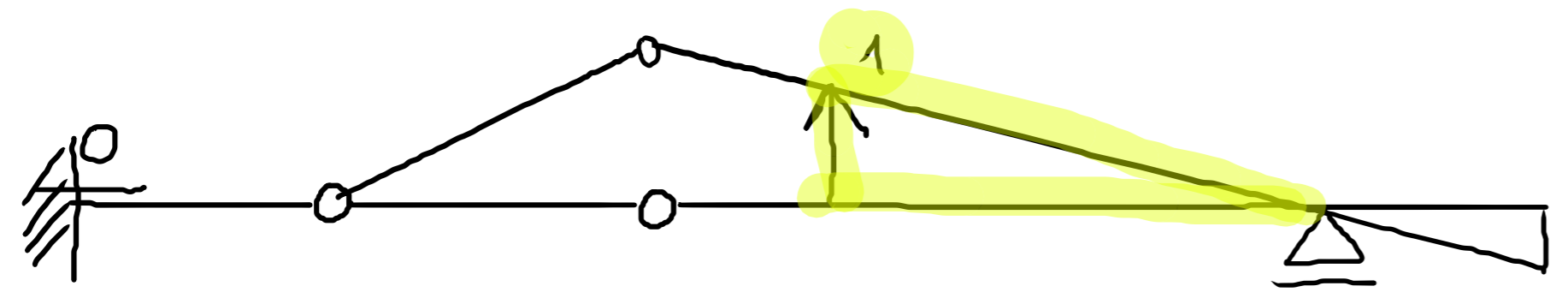

C

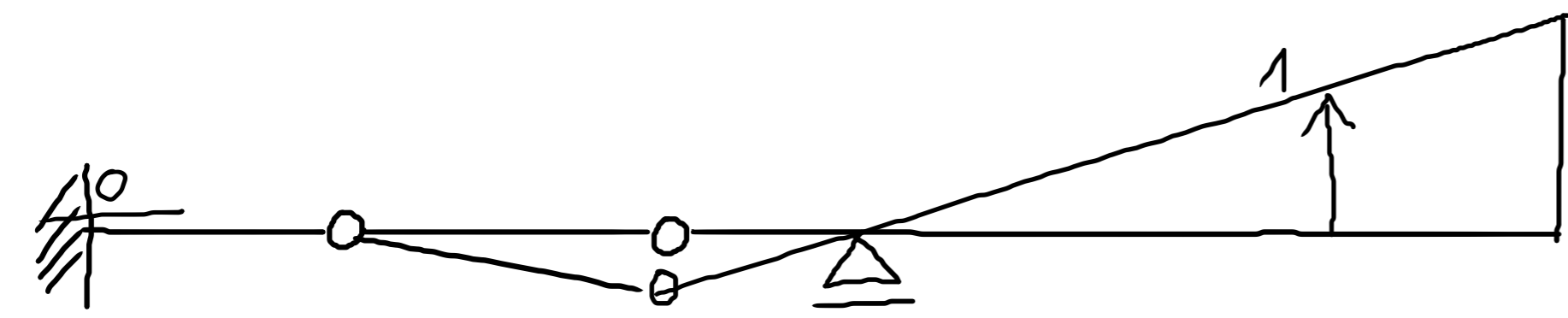

R_H

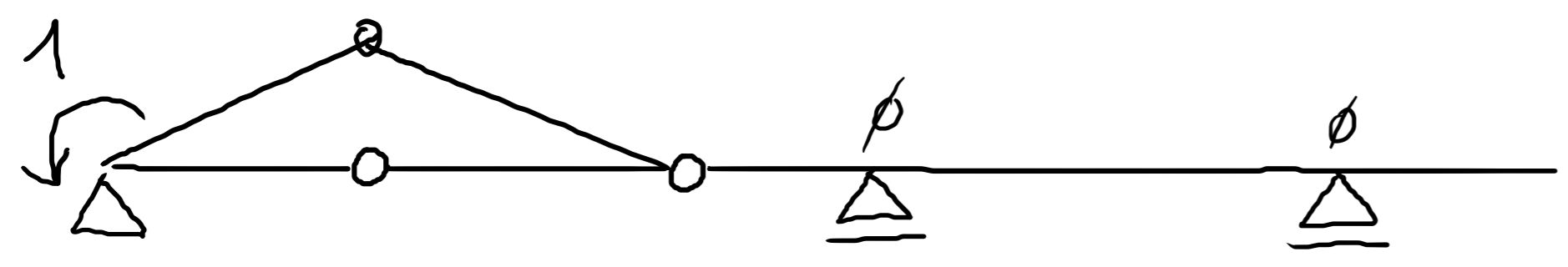

JAK JSME POČÍTALI V.S. NA GERBEROVĚ NOSNÍKU ?

- 1) ROZDĚLIT V KHOUBECH
- 2) USPOŘÁDAT NA NESENE A NESOUČÍ ČÁSTI

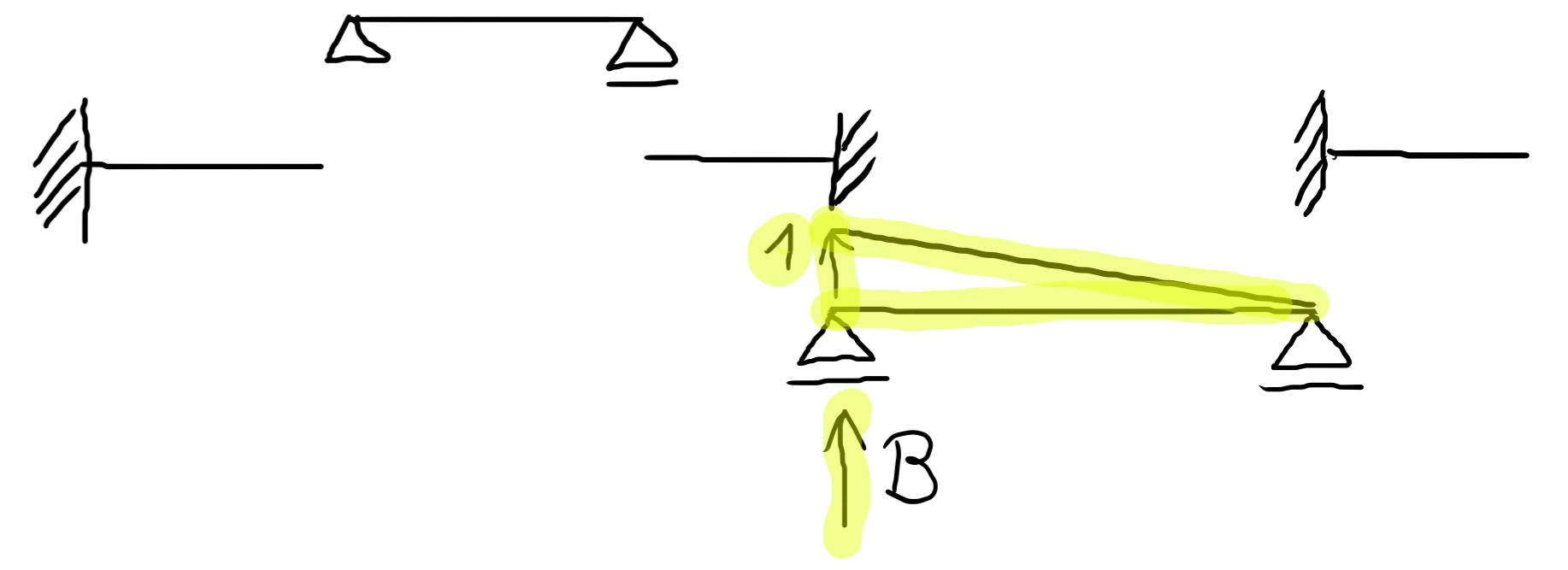
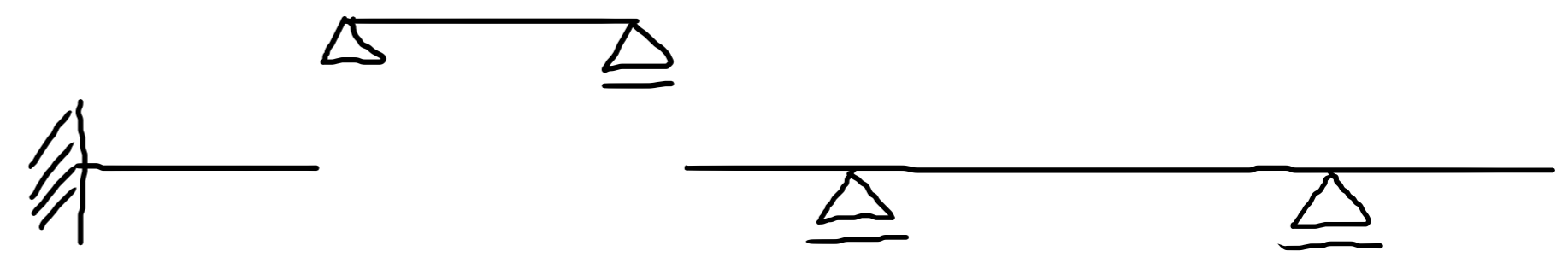

PŘÍČINKOVÉ ČÁRY - GERBERŮV NOSNÍK

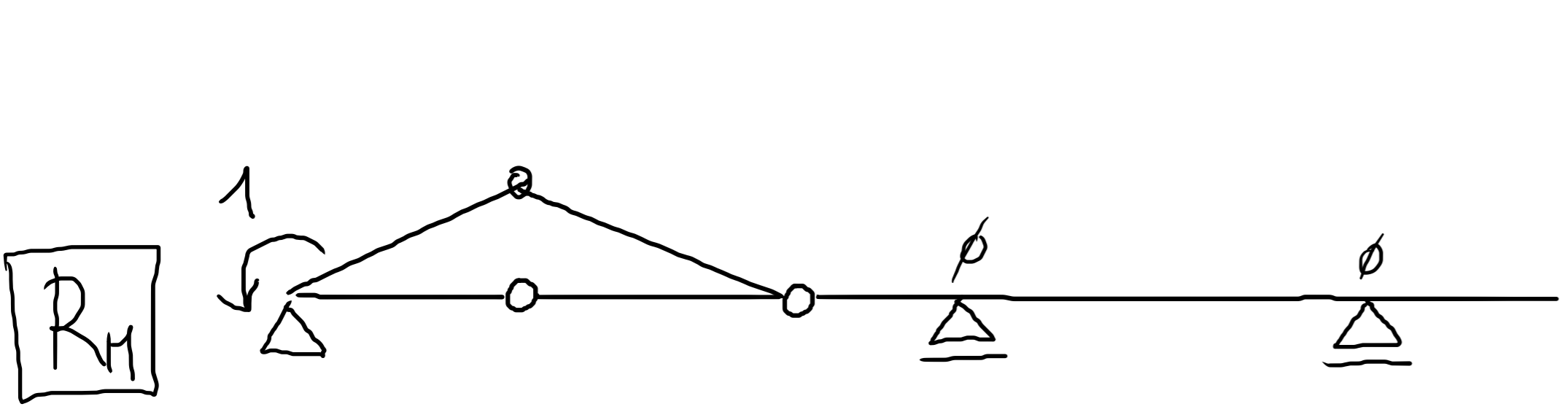
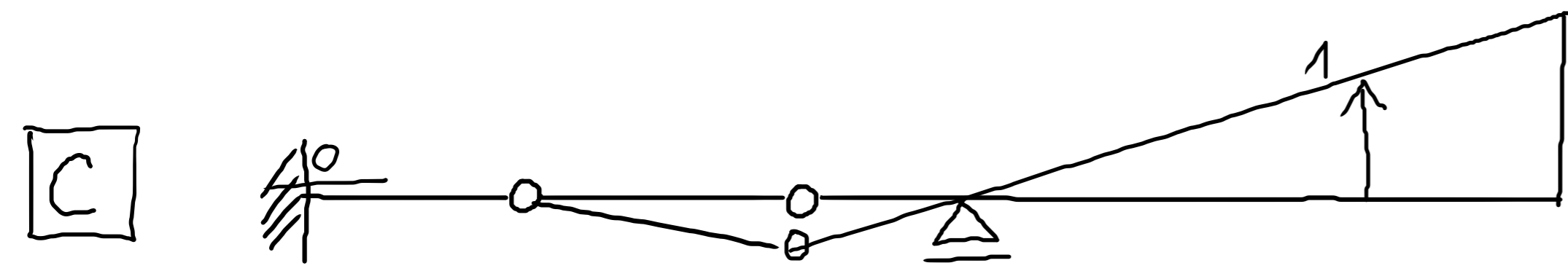
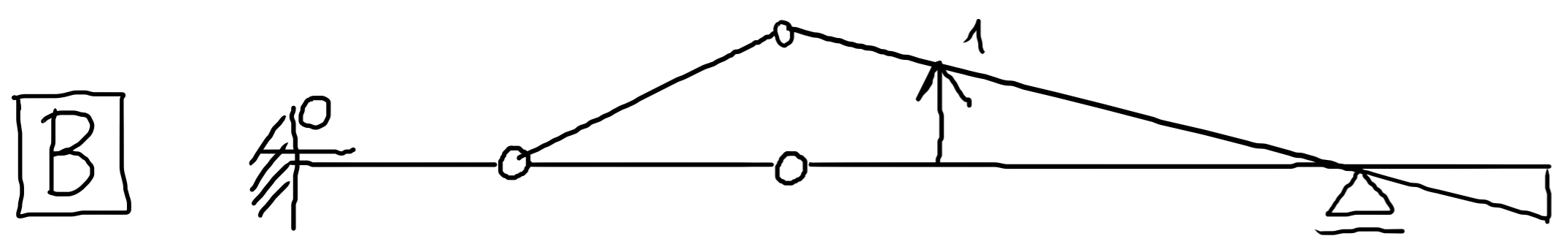
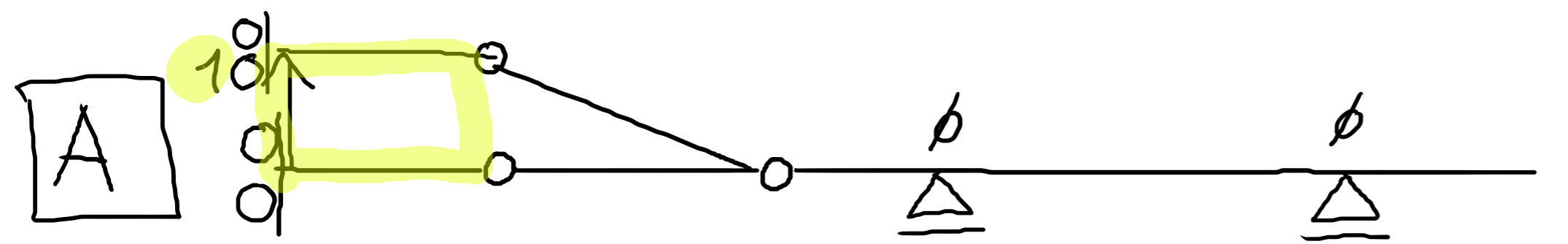
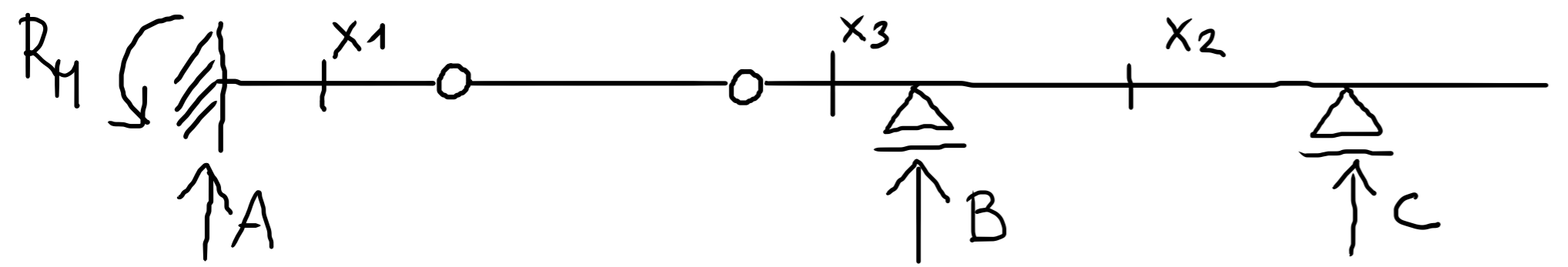

JAK JSME POČÍTALI V.S.
NA GERBEROVĚ NOSNÍKU?

- 1) ROZDĚLIT V KLOUBECH
- 2) USPOŘÁDAT NA NESENE
A NESOUČÍ ČÁSTI

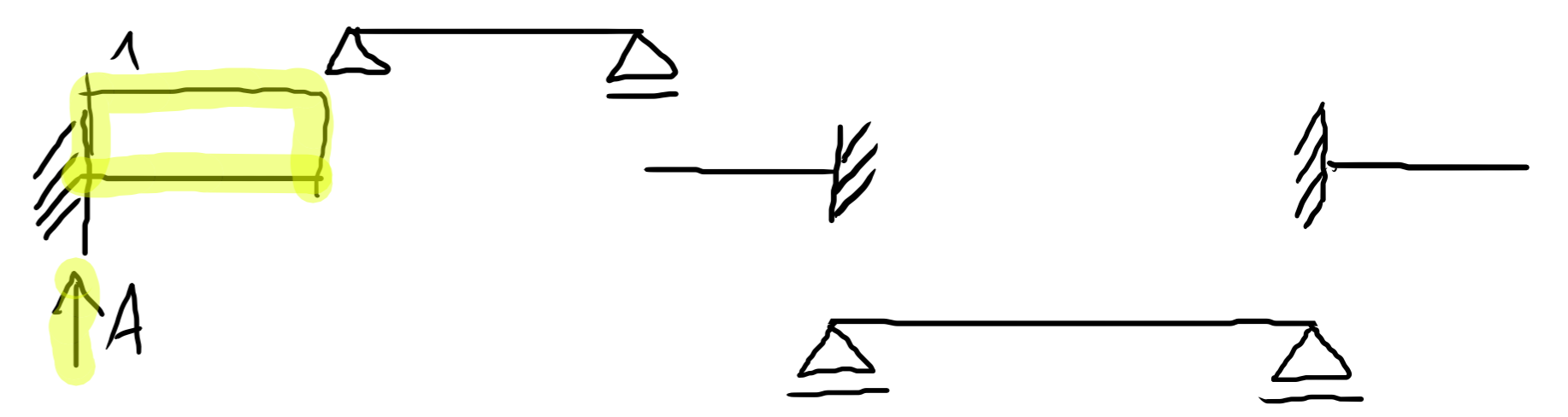
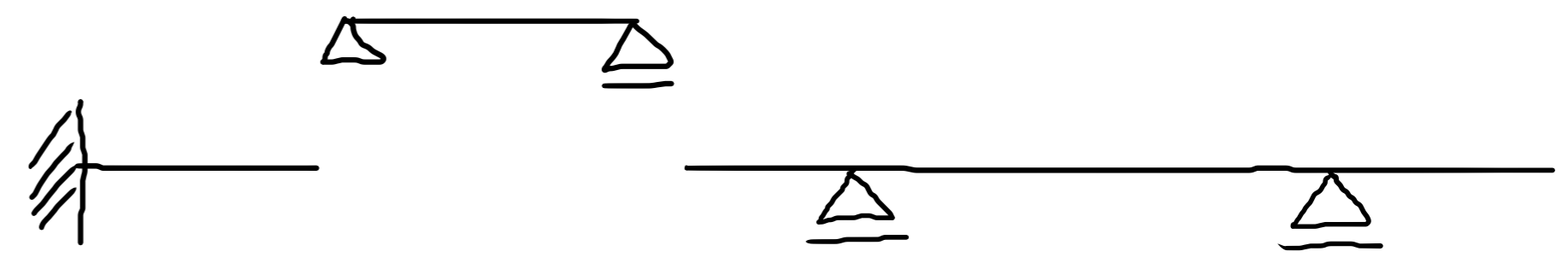

PŘÍČINKOVÉ ČÁRY - GERBERŮV NOSNÍK

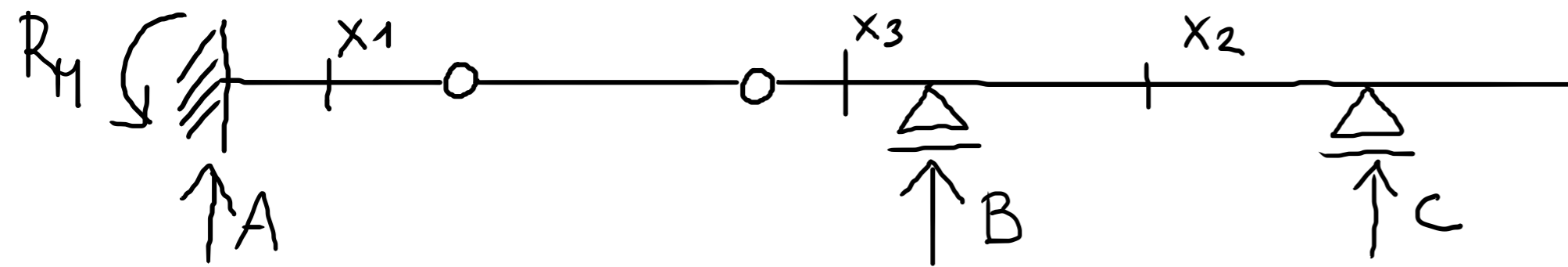

V_{x1}

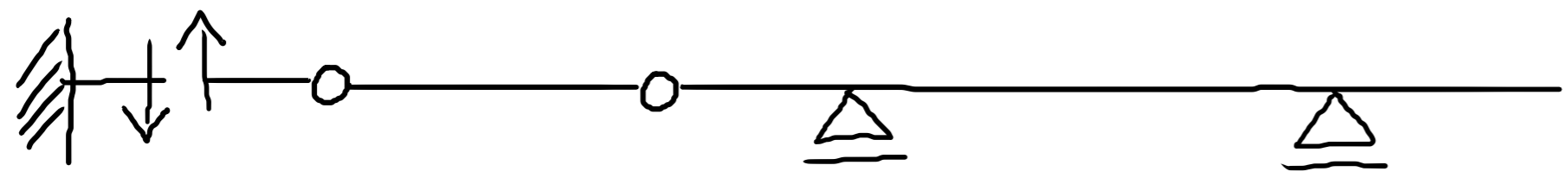

JAK JSME POČÍTALI V.S.
NA GERBEROVĚ NOSNÍKU?

- 1) ROZDĚLIT V KLOUBECH
- 2) USPOŘÁDAT NA NESENE
A NESOUcí ČÁSTI

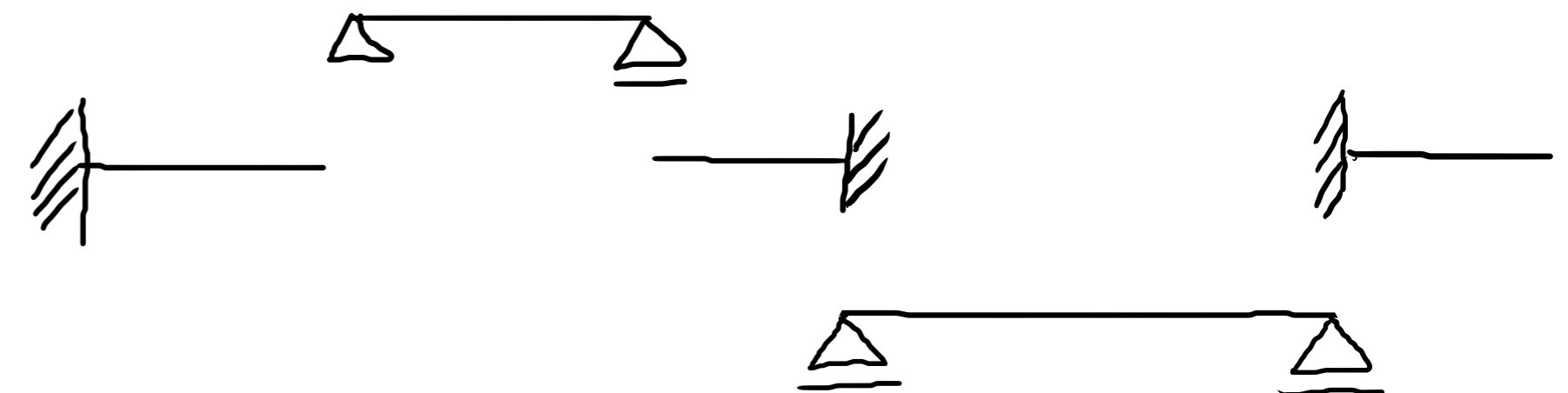
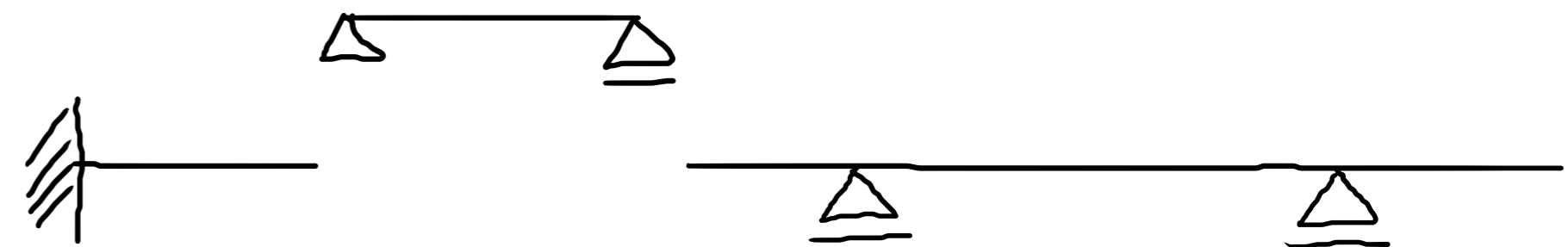

PŘÍČINKOVÉ ČÁRY - GERBERŮV NOSNÍK

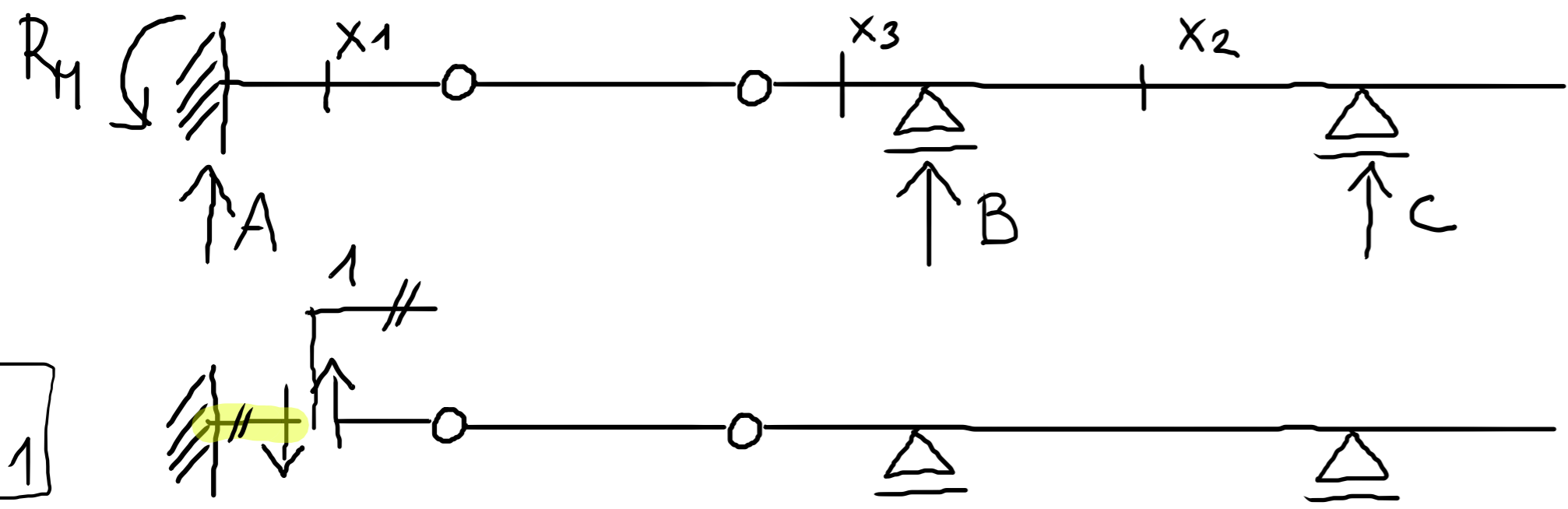

V_{x1}

JAK JSME POČÍTALI V.S.
NA GERBEROVĚ NOSNÍKU ?

- 1) ROZDĚLIT V KLOUBECH
- 2) USPOŘÁDAT NA NESENE
A NESOUcí ČÁSTI

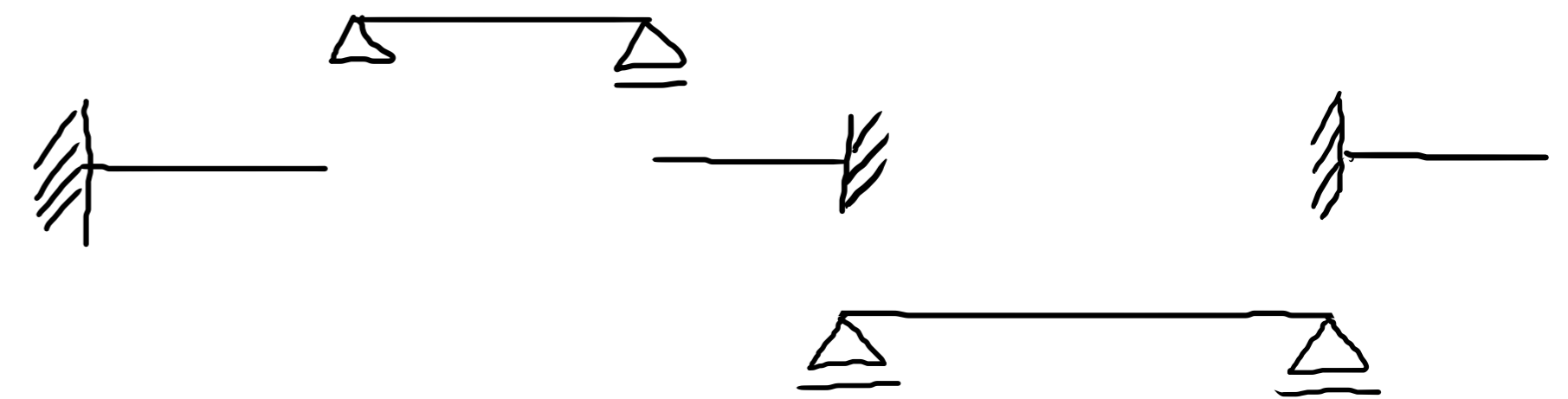
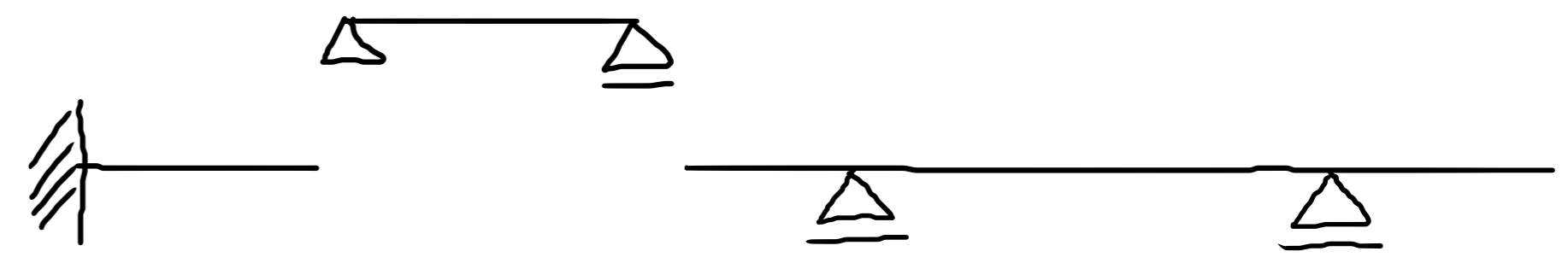

PŘÍČINKOVÉ ČÁRY - GERBERŮV NOSNÍK

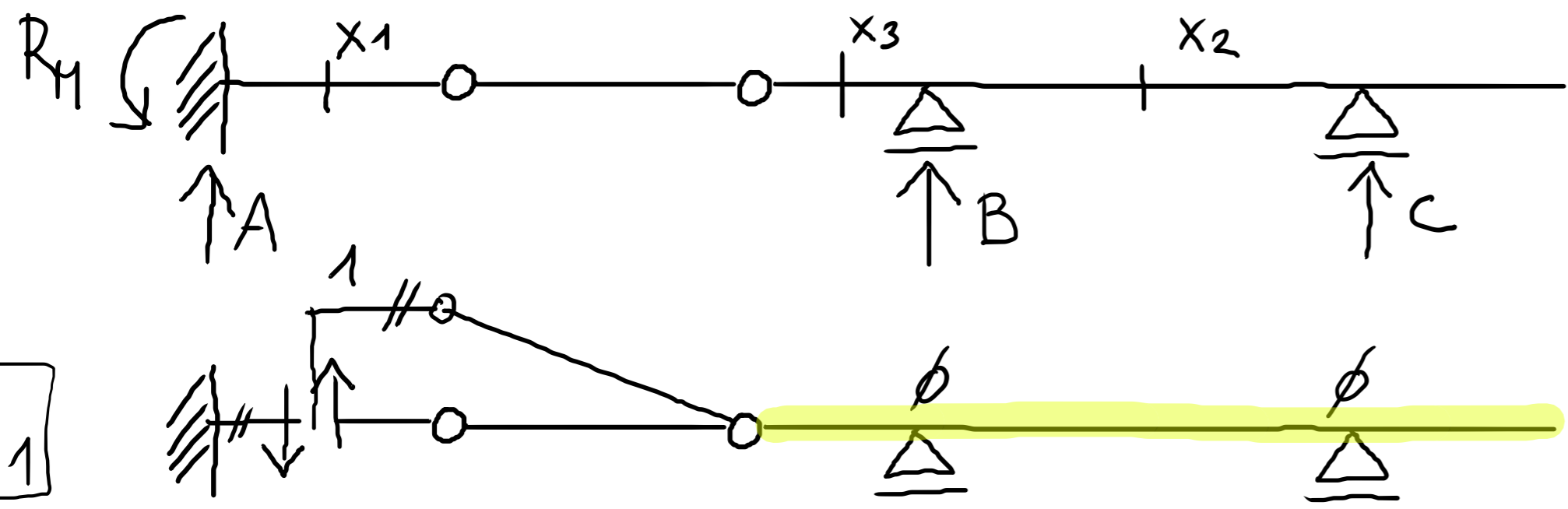

V_{x1}

JAK JSME POČÍTALI V.S.
NA GERBEROVĚ NOSNÍKU ?

- 1) ROZDĚLIT V KLOUBECH
- 2) USPOŘÁDAT NA NESENE
A NESOUČÍ ČÁSTI

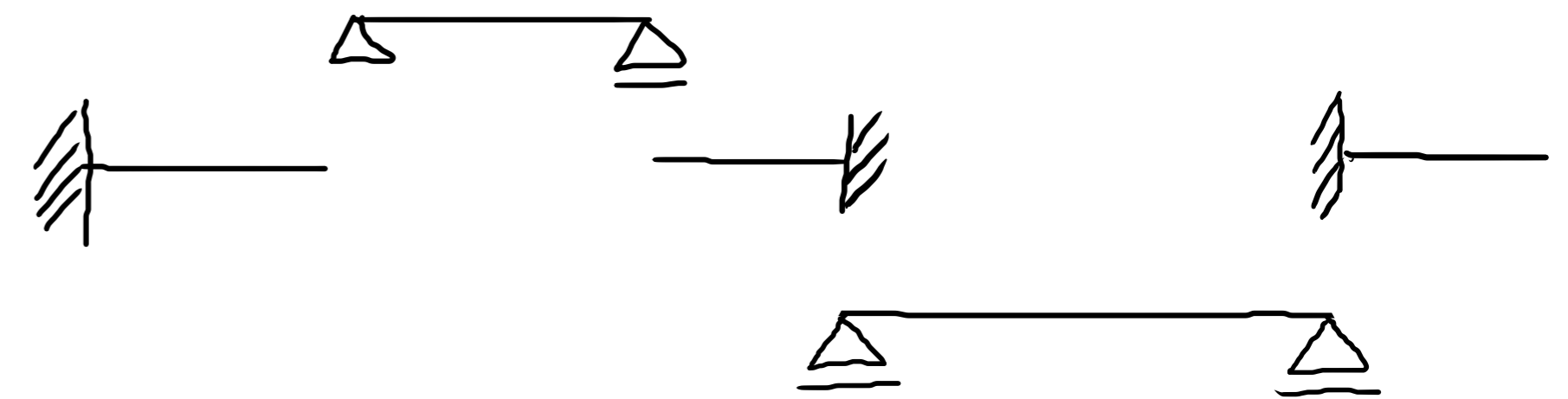
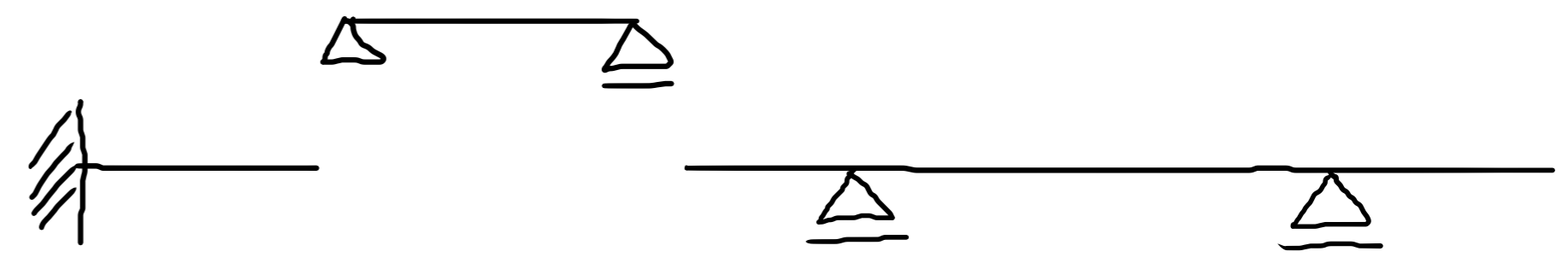

PŘÍČINKOVÉ ČÁRY - GERBERŮV NOSNÍK

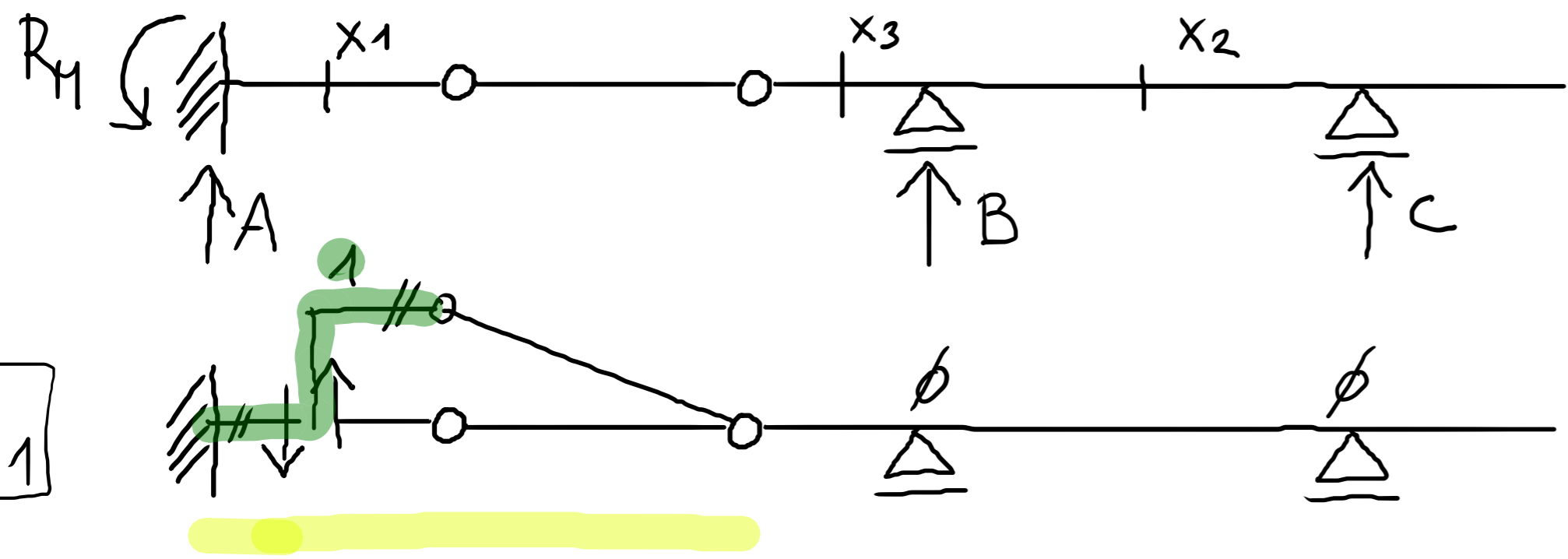

JAK JSME POČÍTALI V.S.
NA GERBEROVĚ NOSNÍKU ?

- 1) ROZDĚLIT V KLOUBECH
- 2) USPOŘÁDAT NA NESENE
A NESOUČÍ ČÁSTI

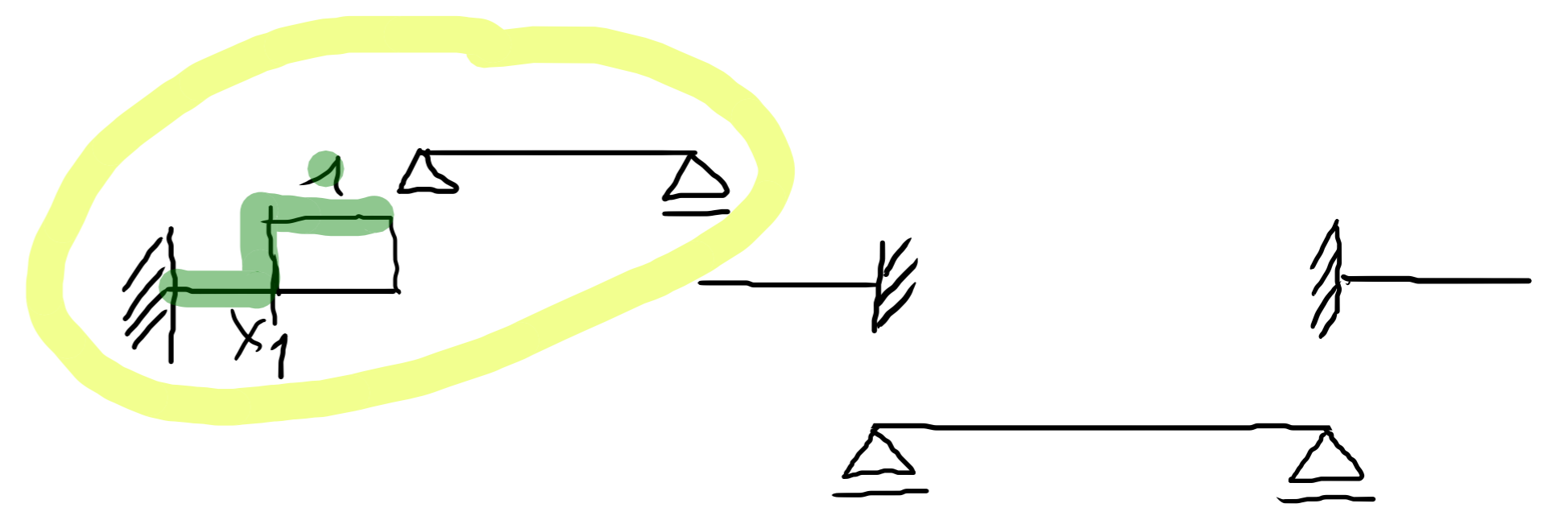
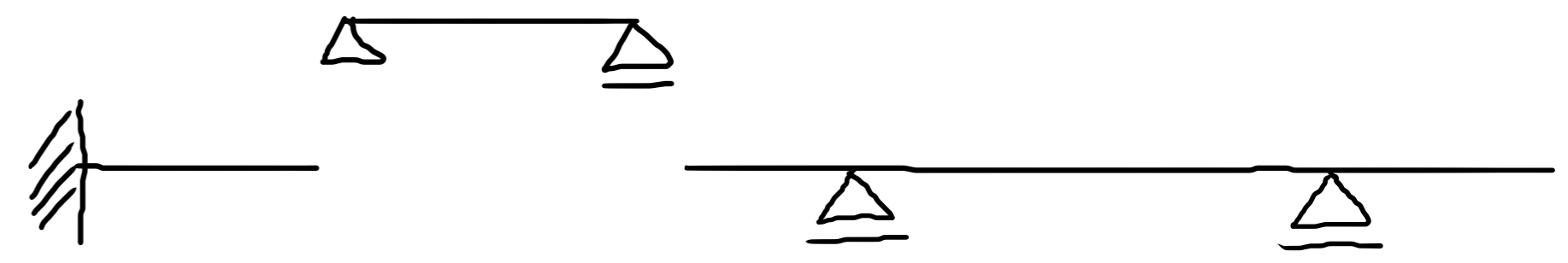

PŘÍČINKOVÉ ČÁRY - GERBERŮV NOSNÍK

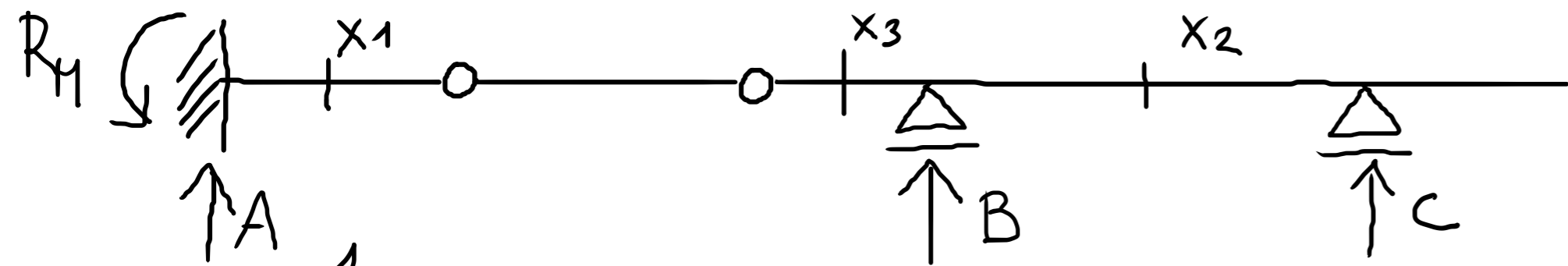

V_{x1}

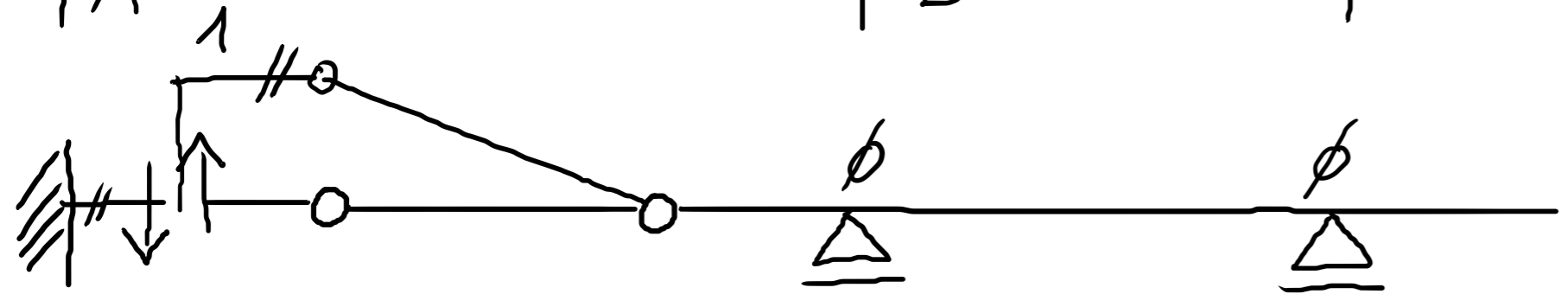

M_{x1}

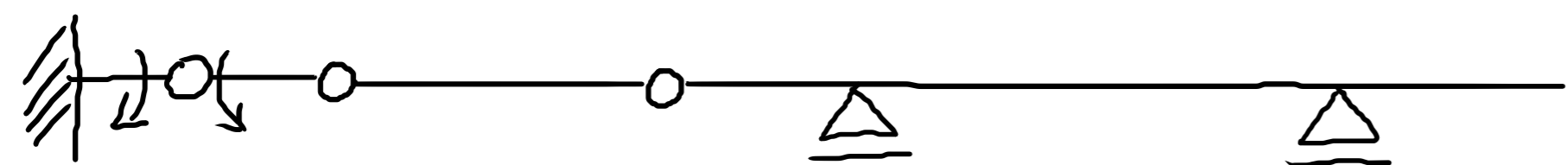

JAK JSME POČÍTALI V.S.
NA GERBEROVĚ NOSNÍKU?

- 1) ROZDĚLIT V KLOUBECH
- 2) USPOŘÁDAT NA NESENE
A NESOUČÍ ČÁSTI

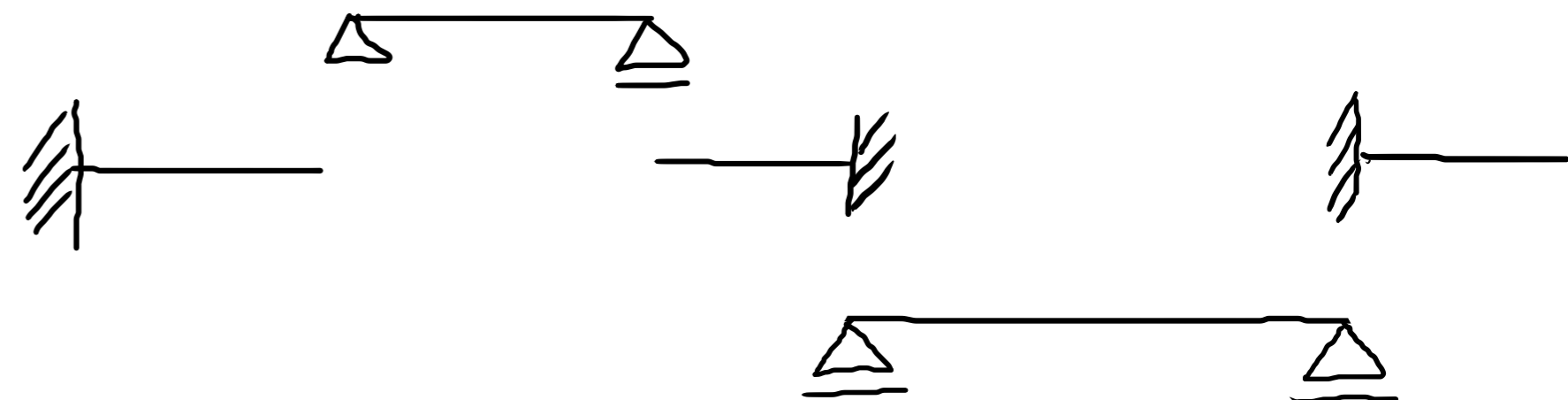
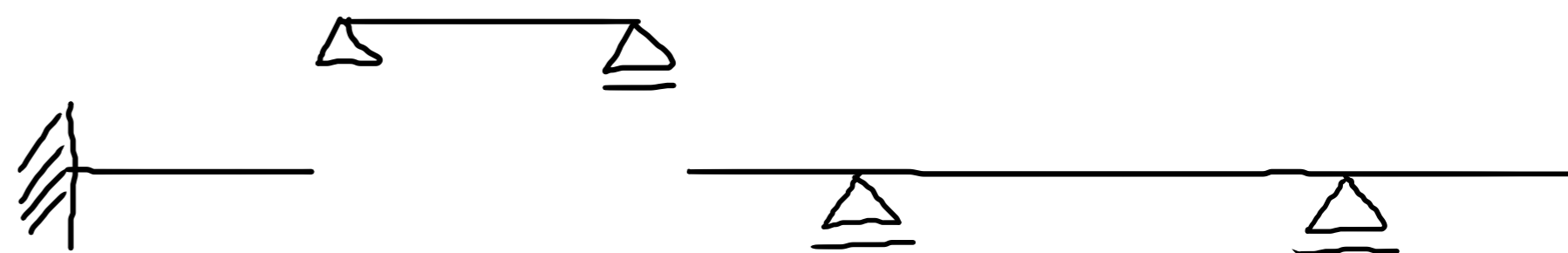

PŘÍČINKOVÉ ČÁRY - GERBERŮV NOSNÍK

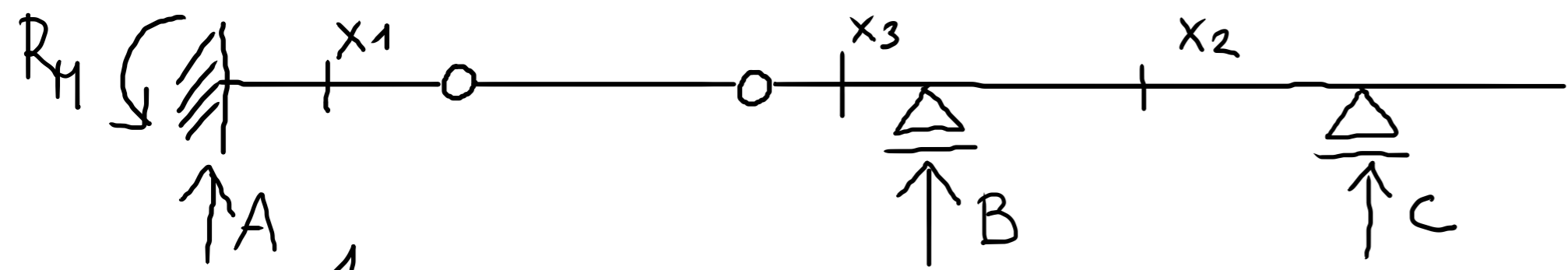

V_{x1}

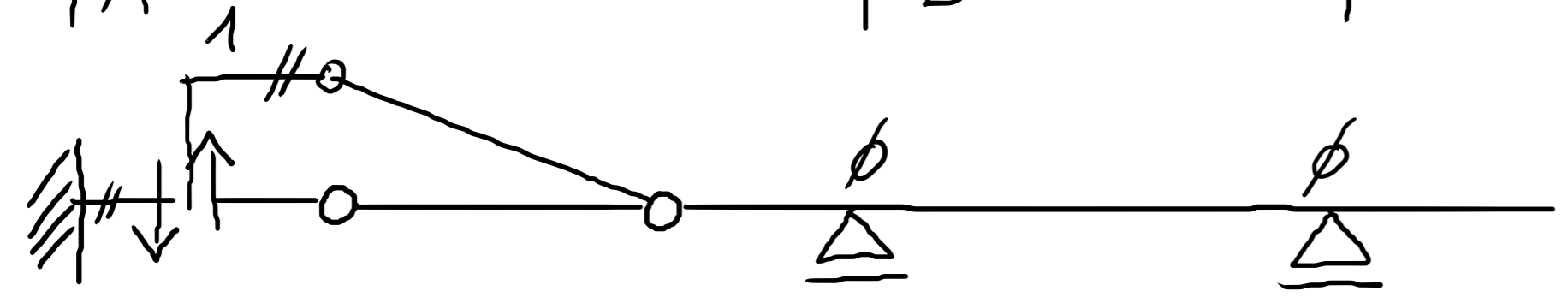

M_{x1}

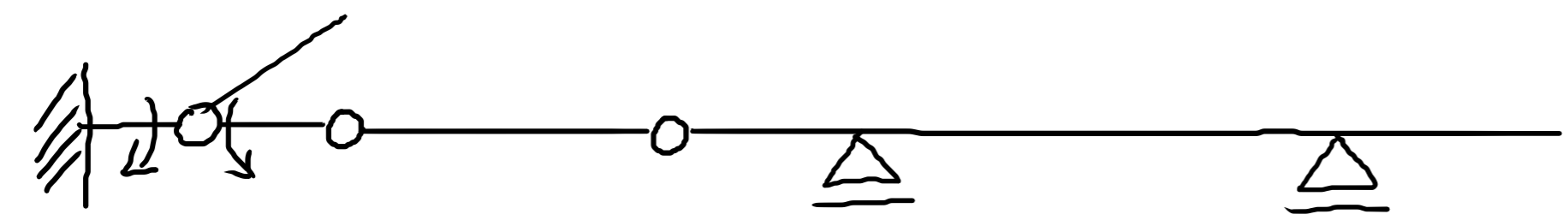

JAK JSME POČÍTALI V.S.
NA GERBEROVĚ NOSNÍKU?

- 1) ROZDĚLIT V KLOUBECH
- 2) USPOŘÁDAT NA NESENEJÍ
A NESOUČÍ ČÁSTI

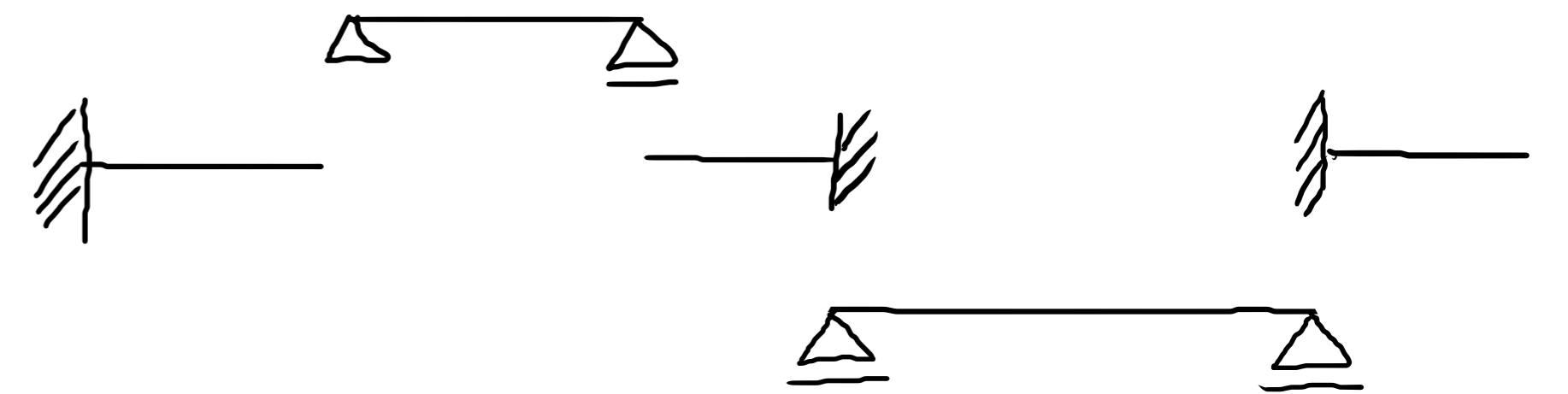
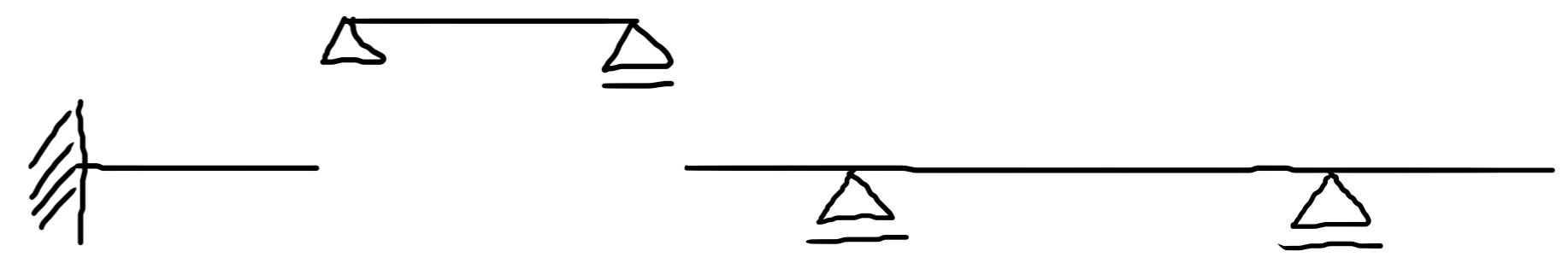

PŘÍČINKOVÉ ČÁRY - GERBERŮV NOSNÍK

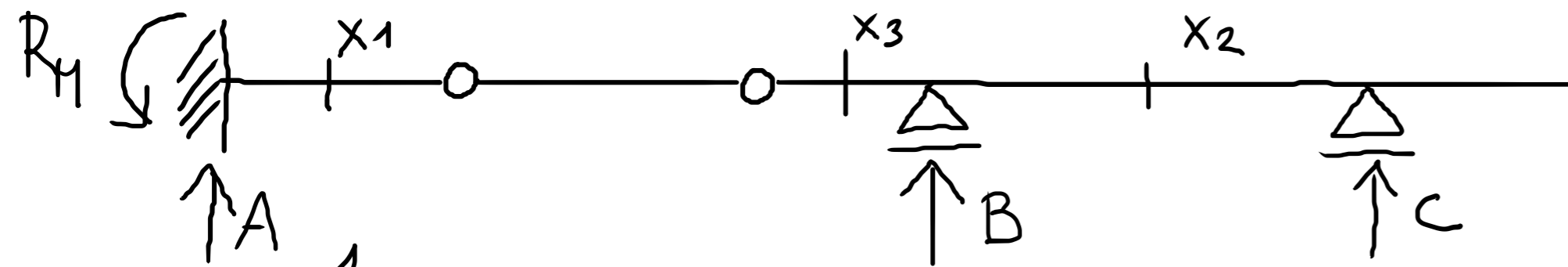

V_{x1}

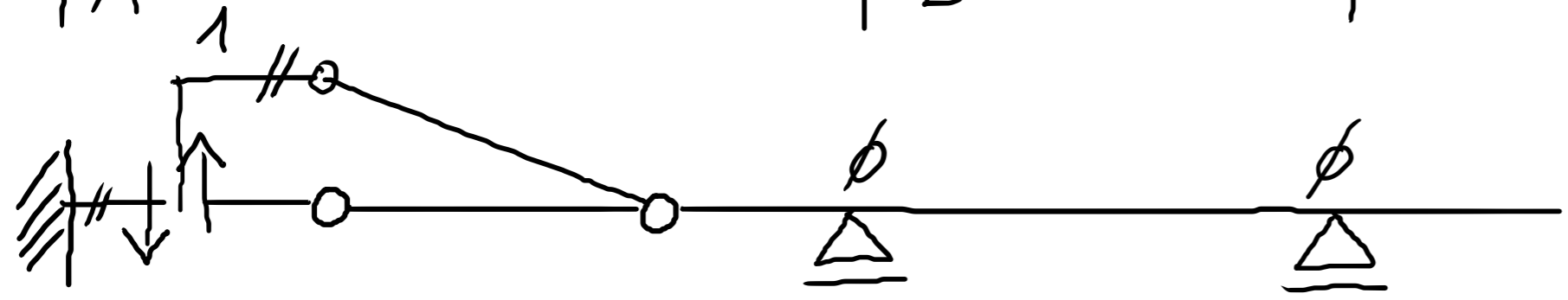

M_{x1}

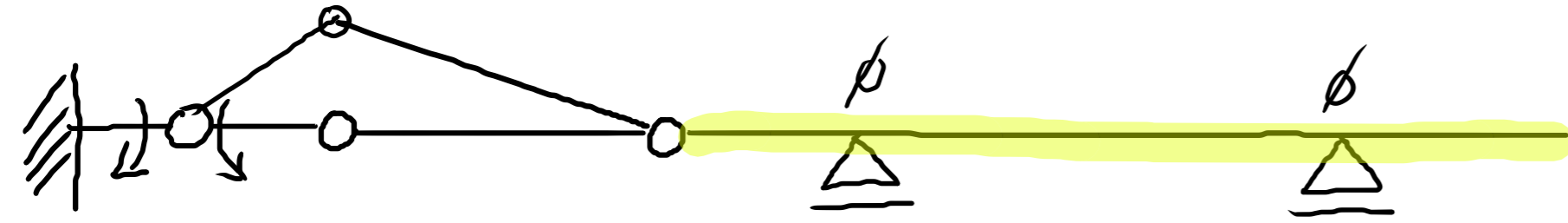

JAK JSME POČÍTALI V.S.
NA GERBEROVĚ NOSNÍKU?

- 1) ROZDĚLIT V KLOUBECH
- 2) USPOŘÁDAT NA NESENEJÍ
A NESOUČÍ ČÁSTI

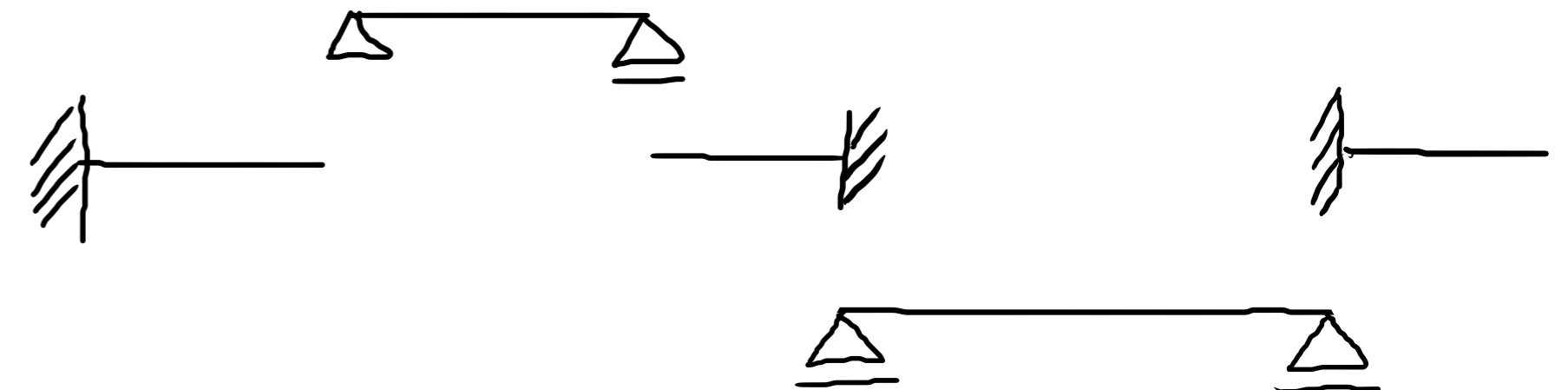
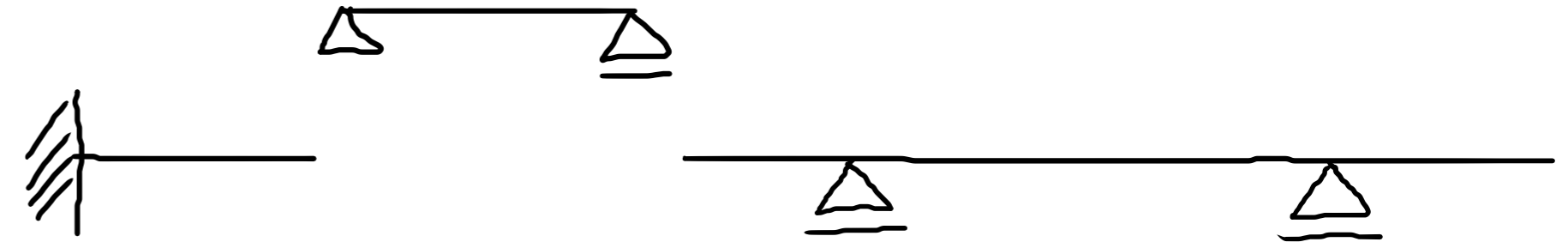

PŘÍČINKOVÉ ČÁRY - GERBERŮV NOSNÍK

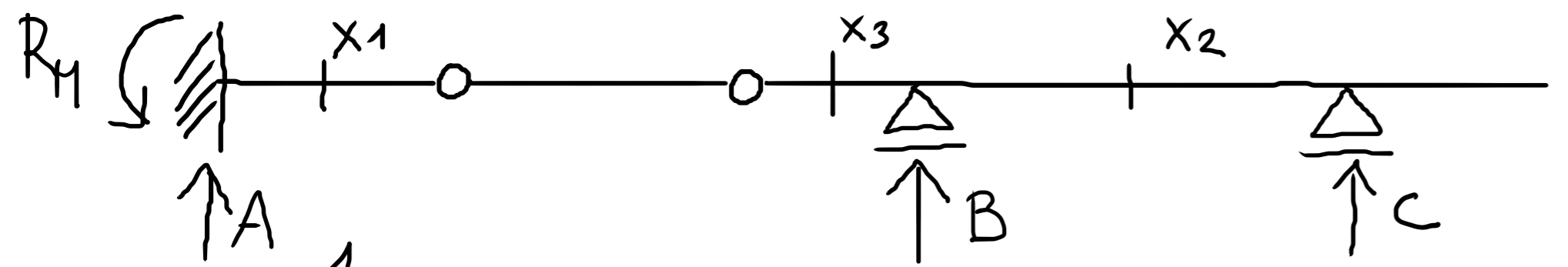

V_{x1}

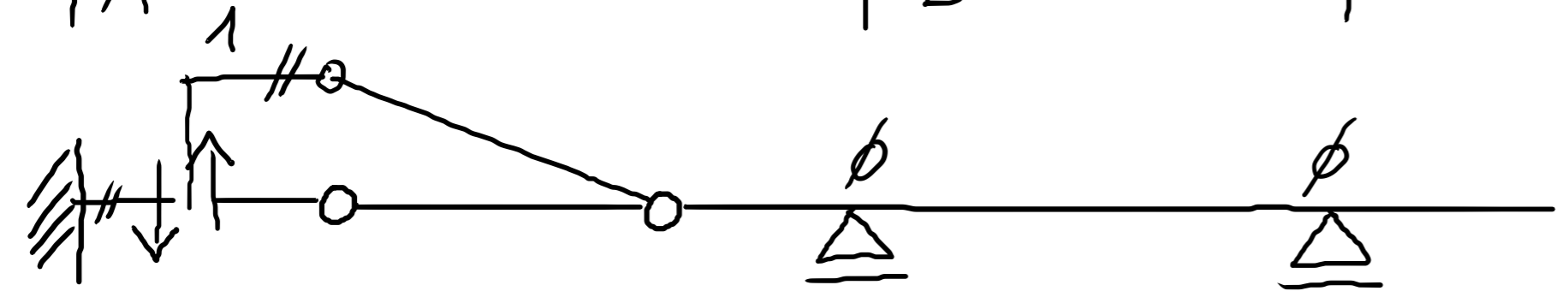

M_{x1}

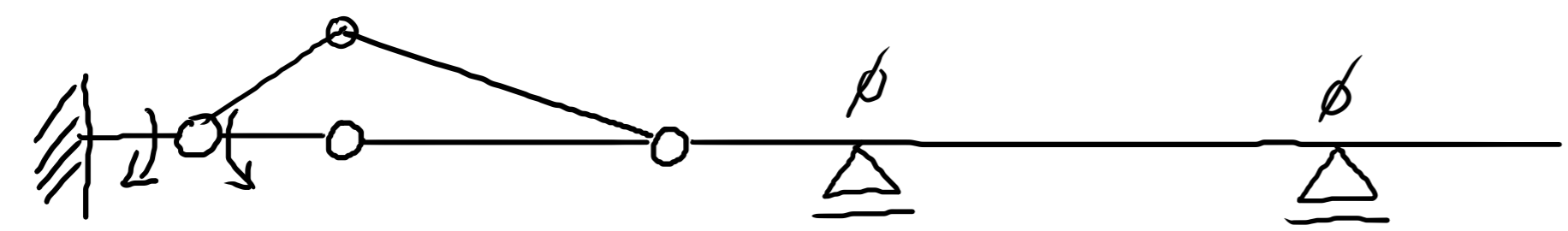

V_{x2}

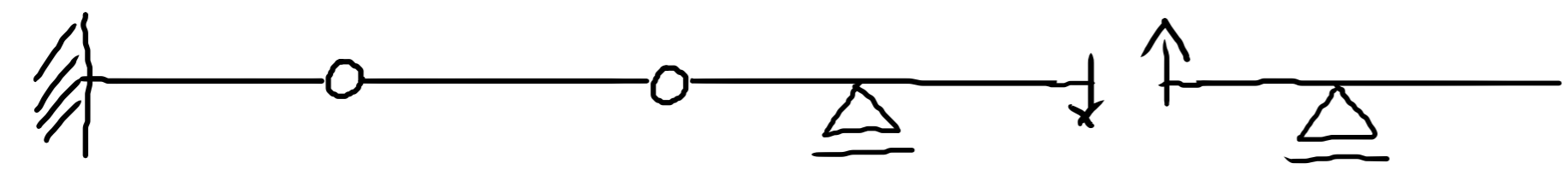

M_{x2}

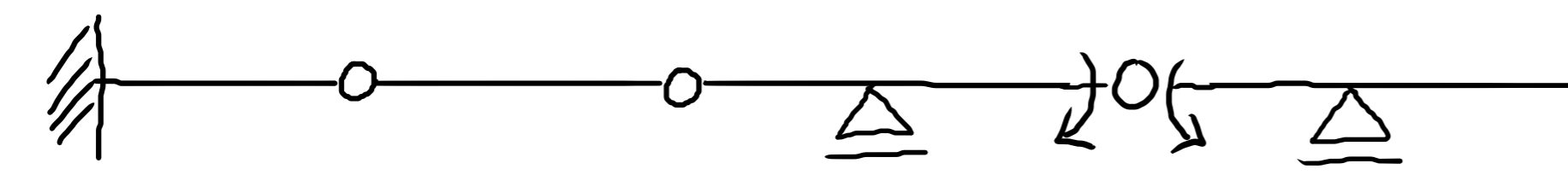

V_{x3}

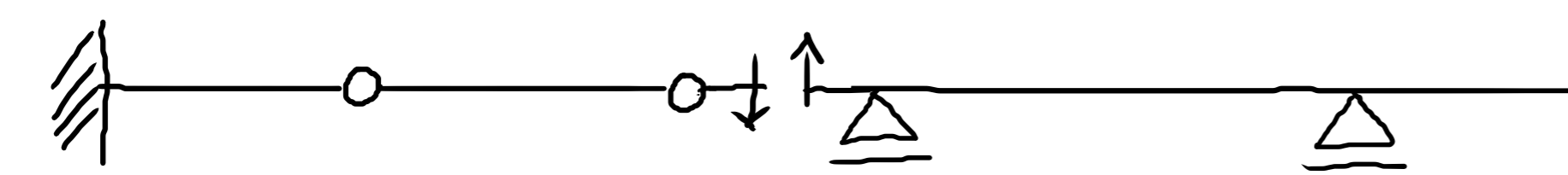

M_{x3}

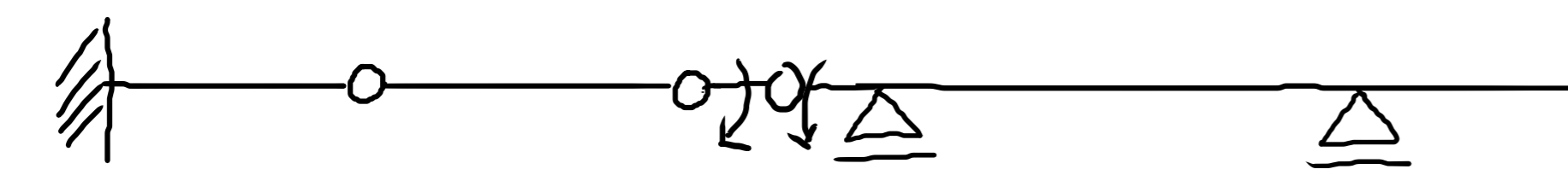

JAK JSME POČÍTALI V.S.
NA GERBEROVĚ NOSNÍKU?

- 1) ROZDĚLIT V KLOUBECH
- 2) USPOŘÁDAT NA NESENEJÍ
A NESOUČÍ ČÁSTI

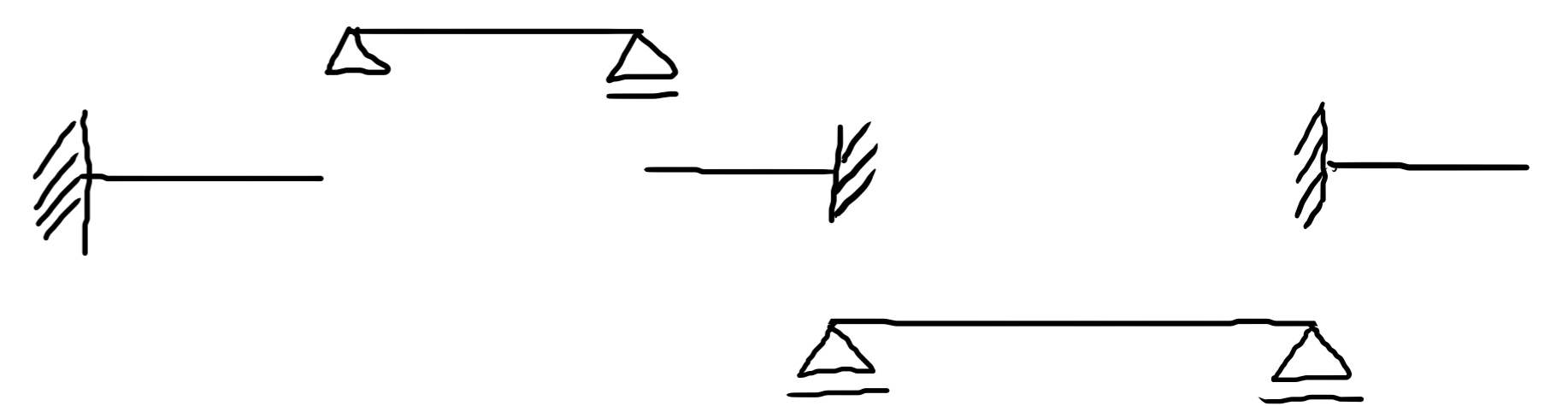
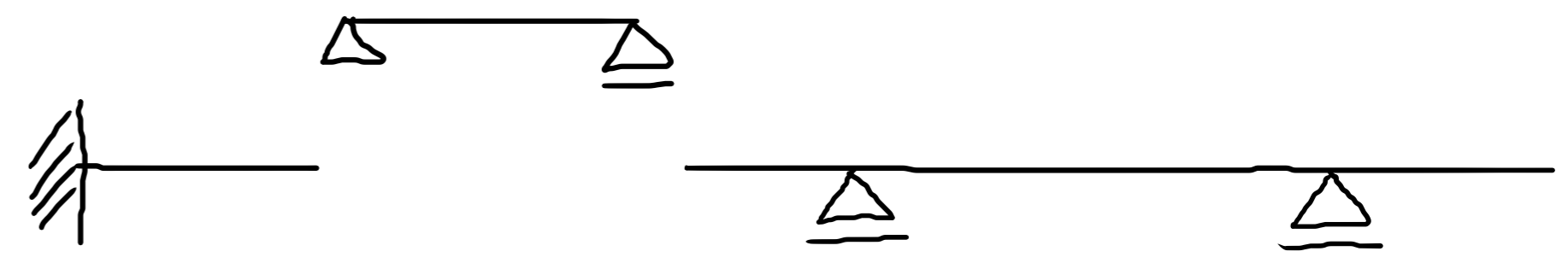

PŘÍČINKOVÉ ČÁRY - GERBERŮV NOSNÍK

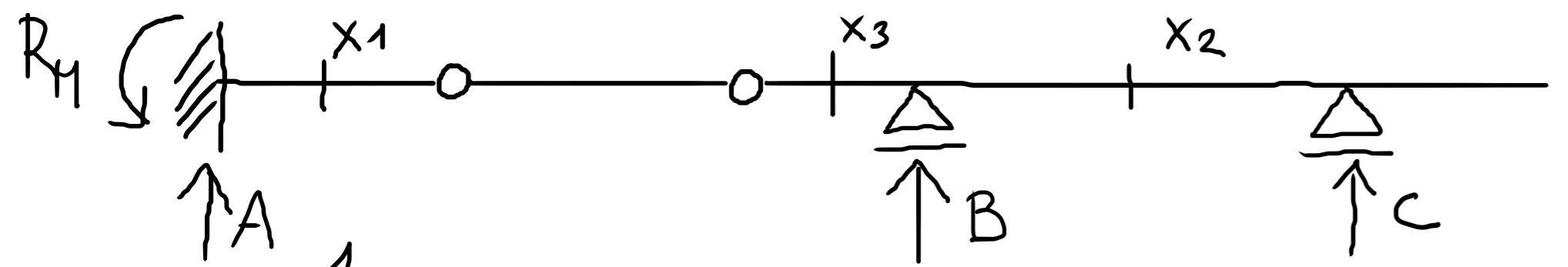

V_{x1}

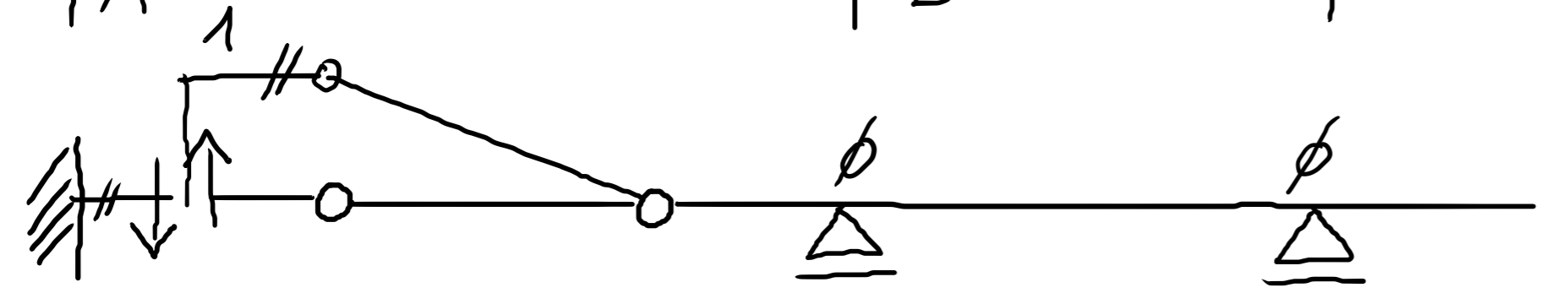

M_{x1}

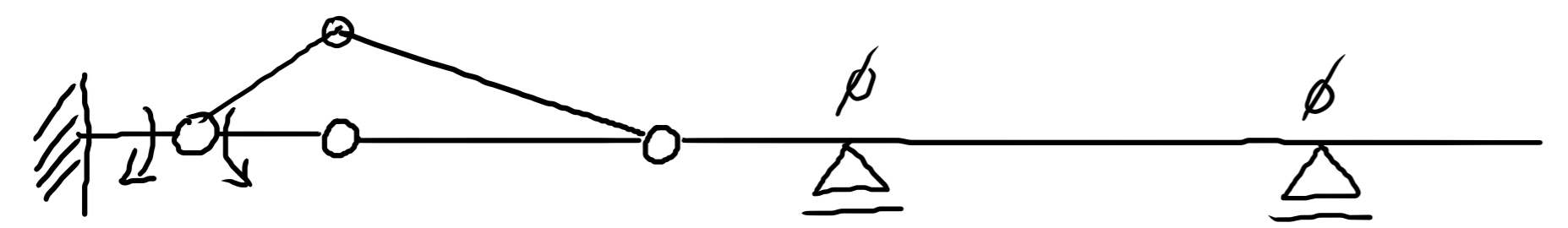

V_{x2}

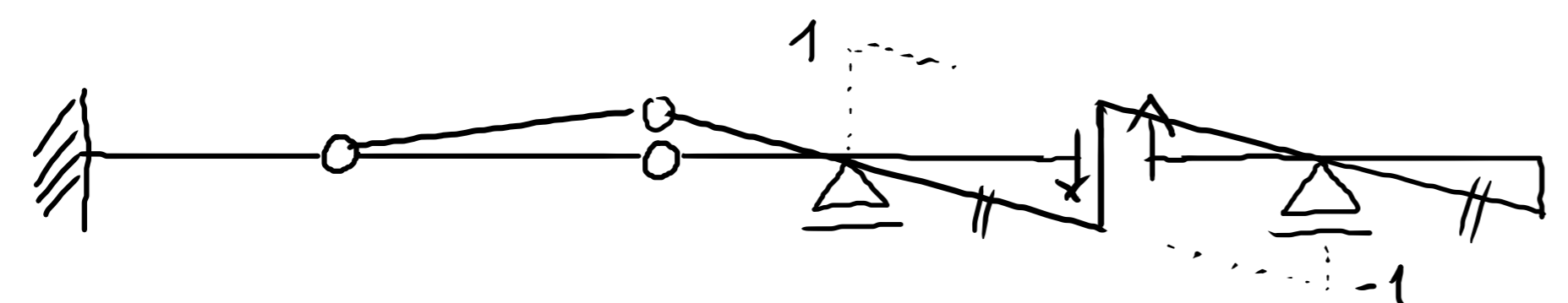

M_{x2}

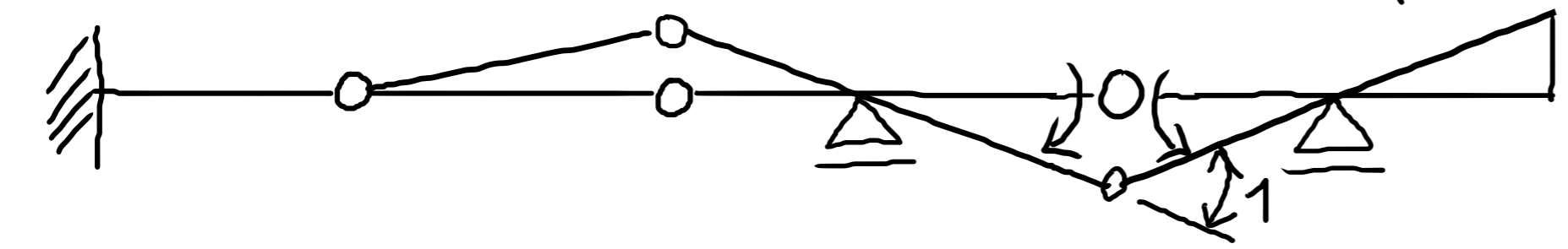

V_{x3}

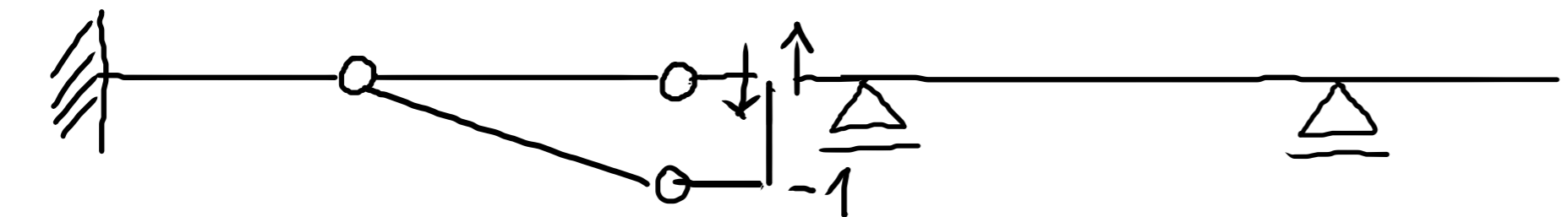

M_{x3}

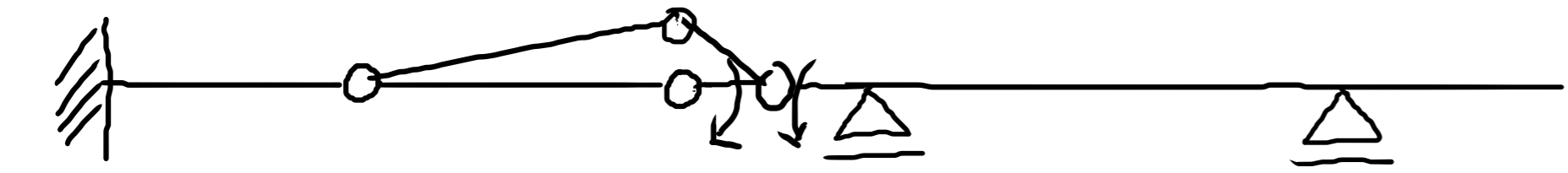

JAK JSME POČÍTALI V.S.
NA GERBEROVĚ NOSNÍKU?

- 1) ROZDĚLIT V KLOUBECH
- 2) USPOŘÁDAT NA NESENEJÍ
A NESOUČÍ ČÁSTI

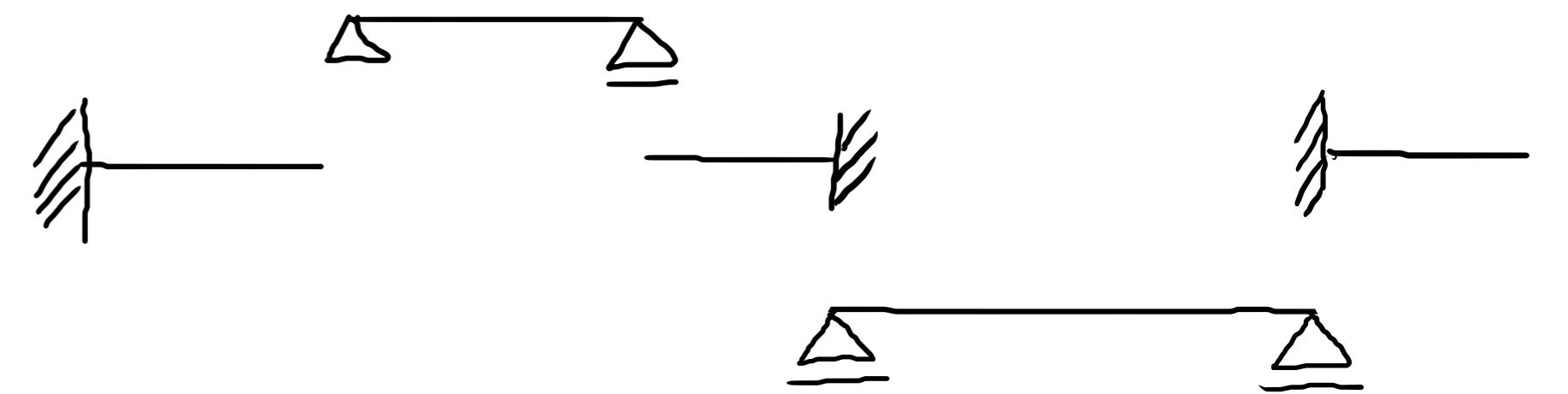
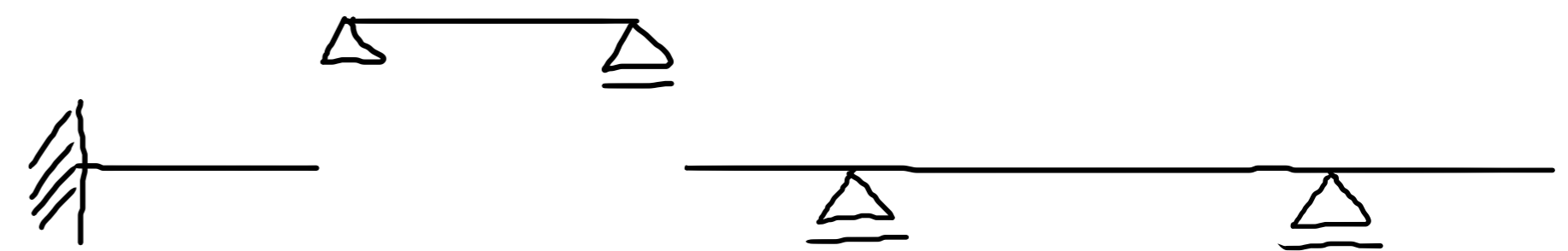

PŘÍČINKOVÉ ČÁRY - GERBERŮV NOSNÍK

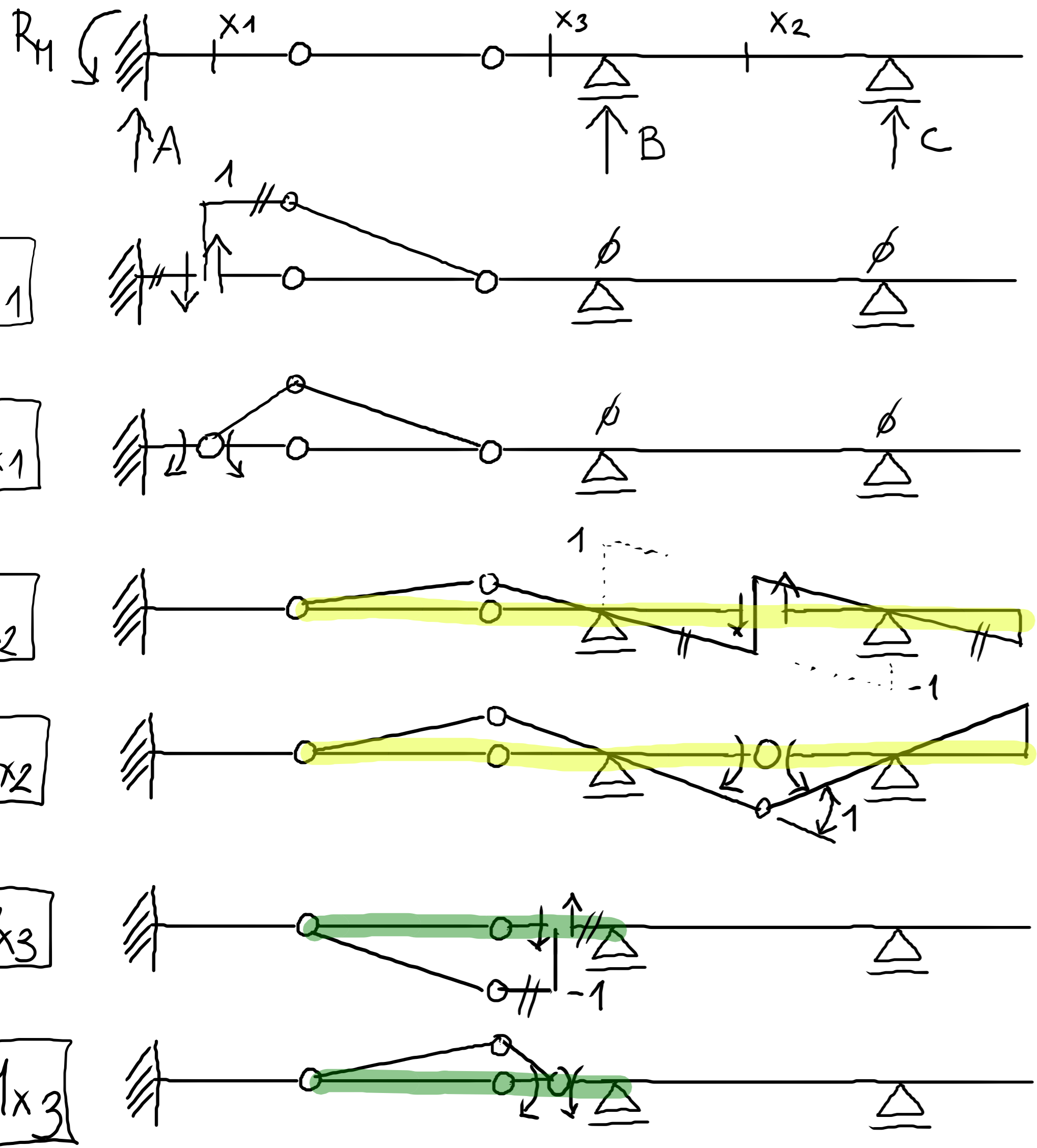

JAK JSME POČÍTALI V.S. NA GERBEROVĚ NOSNÍKU?

- 1) ROZDĚLIT V KLOUBECH
- 2) USPOŘÁDAT NA NESENEJÍ A NESOUČÍ ČÁSTI

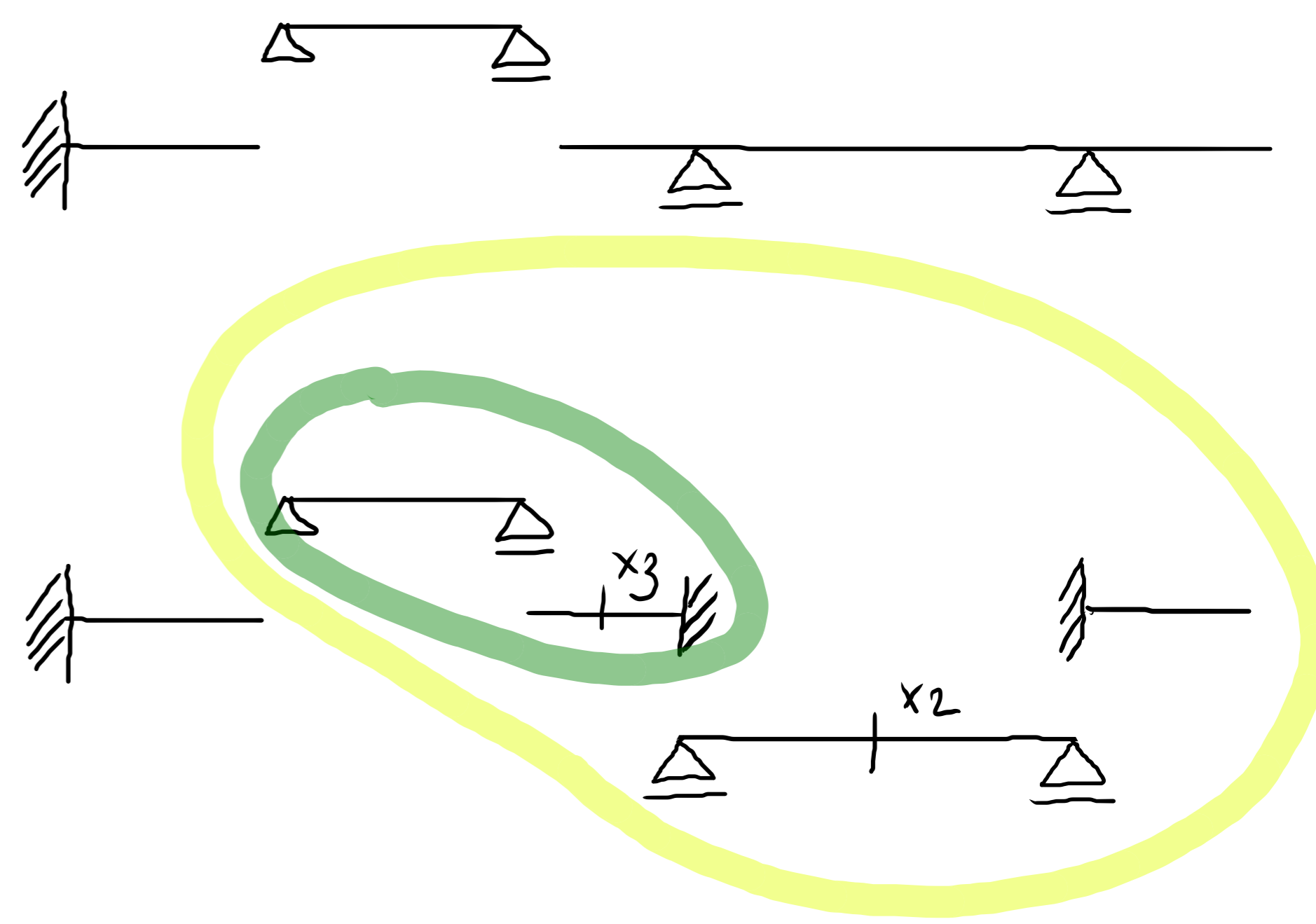

PŘÍČINKOVÉ ČÁRY - SPOJITÝ NOSNÍK (S P. K.)

PŘÍČINKOVÉ ČÁRY - SPOJITÝ NOSNÍK

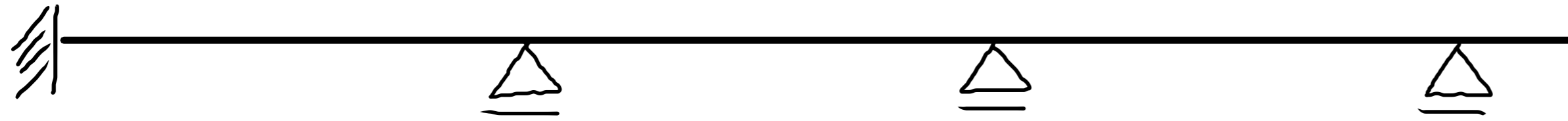

PŘÍČINKOVÉ ČÁRY - SPOJITÝ NOSNÍK

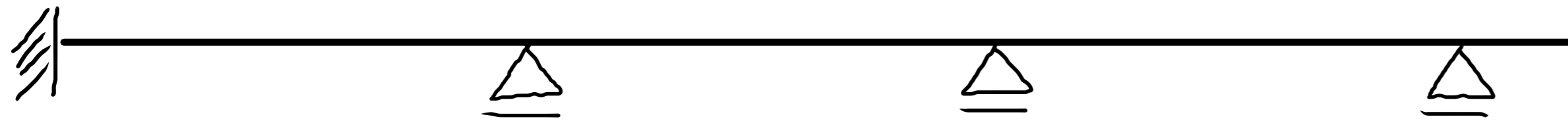

S.U. \rightarrow MAX 1°

S.N. \rightarrow VŽDY 3°

PŘÍČINKOVÉ ČÁRY - SPOJITÝ NOSNÍK

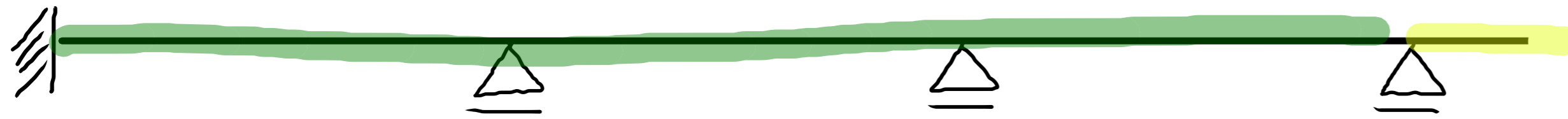

S.U. \rightarrow MAX 1°

S.N. \rightarrow VŽDY 3°

PŘÍČINKOVÉ ČÁRY - SPOJITÝ NOSNÍK

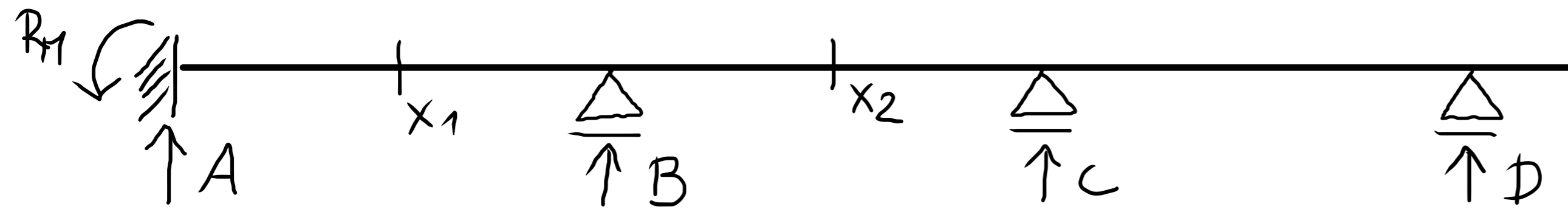

S.U. \rightarrow MAX 1°

S.N. \rightarrow VŽDY 3°

PŘÍČINKOVÉ ČÁRY - SPOJITÝ NOSNÍK

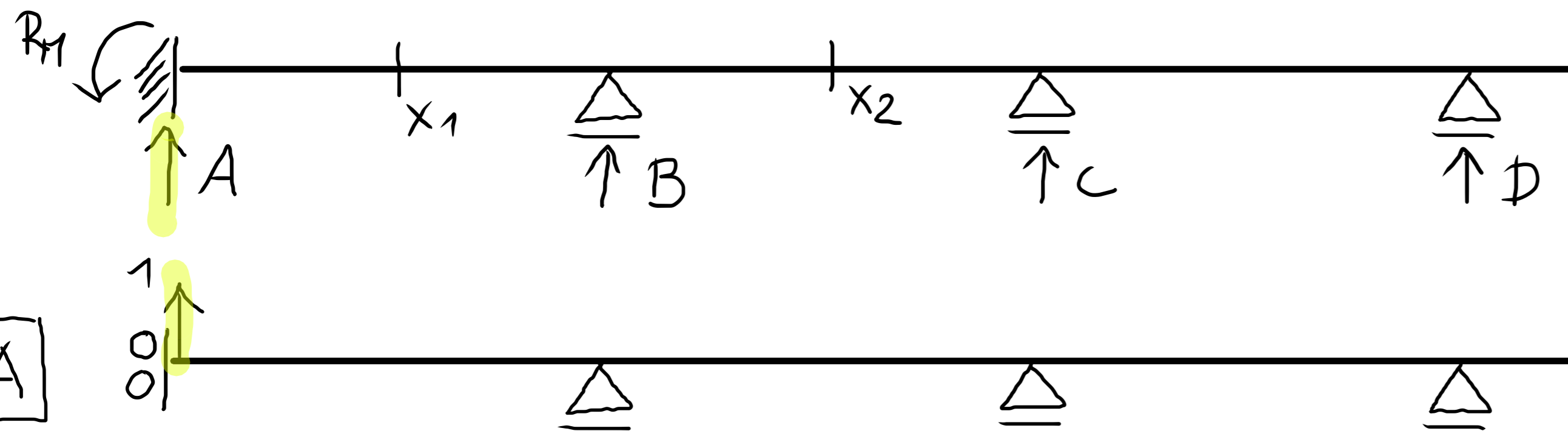

S.U. \rightarrow MAX 1°

S.N. \rightarrow VŽDY 3°

PŘÍČINKOVÉ ČÁRY - SPOJITÝ NOSNÍK

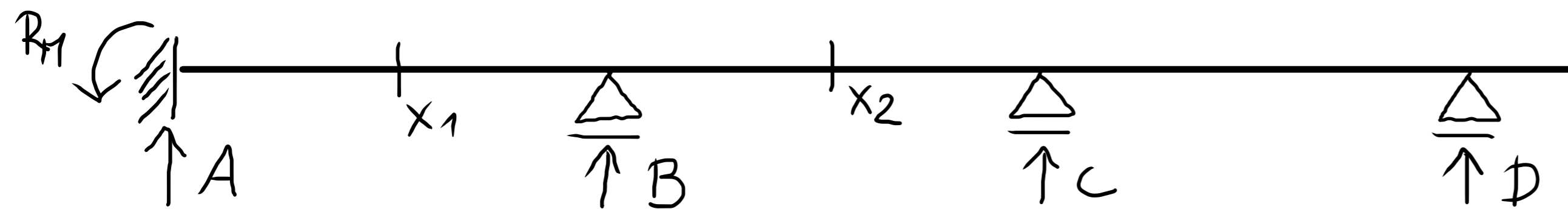

A

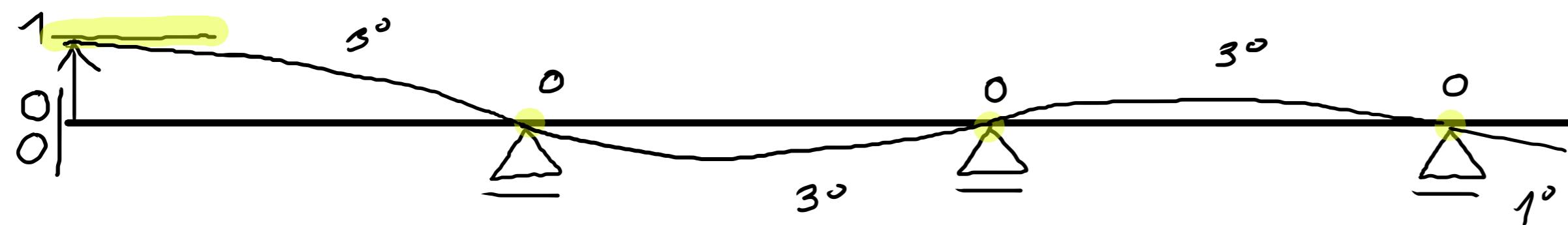

S.U. \rightarrow MAX 1°

S.N. \rightarrow VŽDY 3°

PŘÍČINKOVÉ ČÁRY - SPOJITÝ NOSNÍK

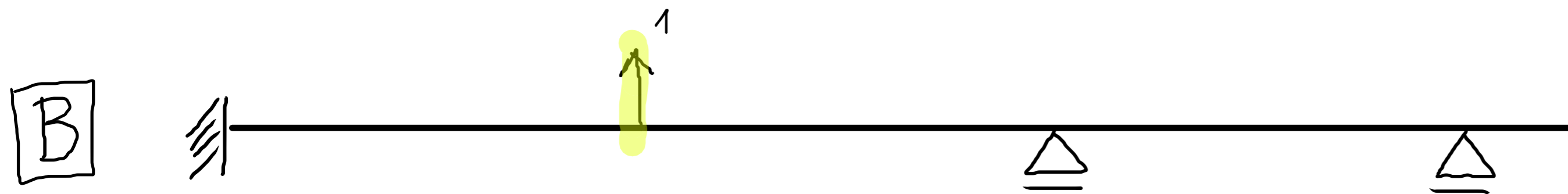
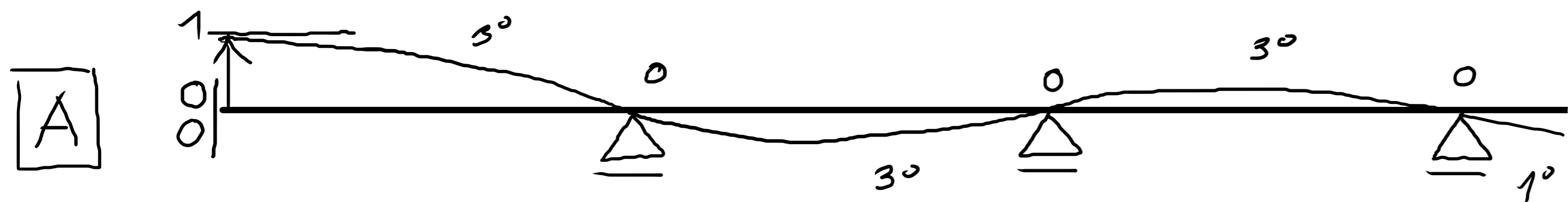
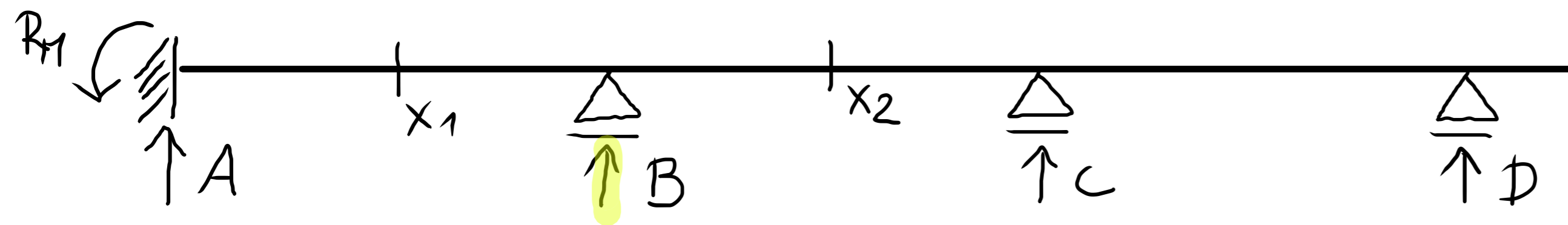

S.U. \rightarrow MAX 1°

S.N. \rightarrow VŽDY 3°

PŘÍČINKOVÉ ČÁRY - SPOJITÝ NOSNÍK

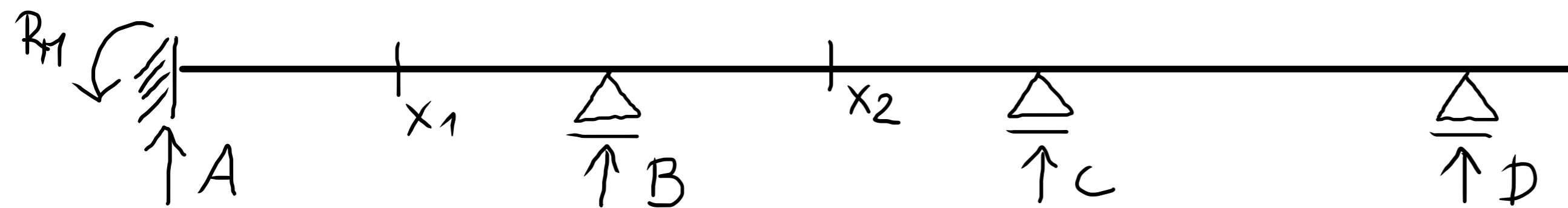

A



B

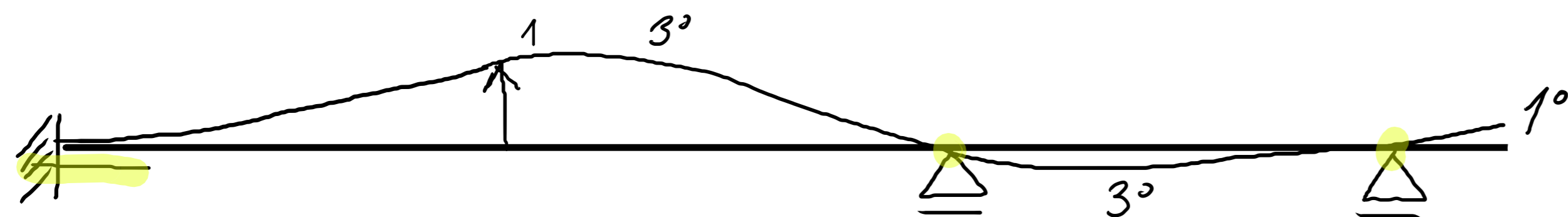

S.U. \rightarrow MAX 1°

S.N. \rightarrow VŽDY 3°

PŘÍČINKOVÉ ČÁRY - SPOJITÝ NOSNÍK

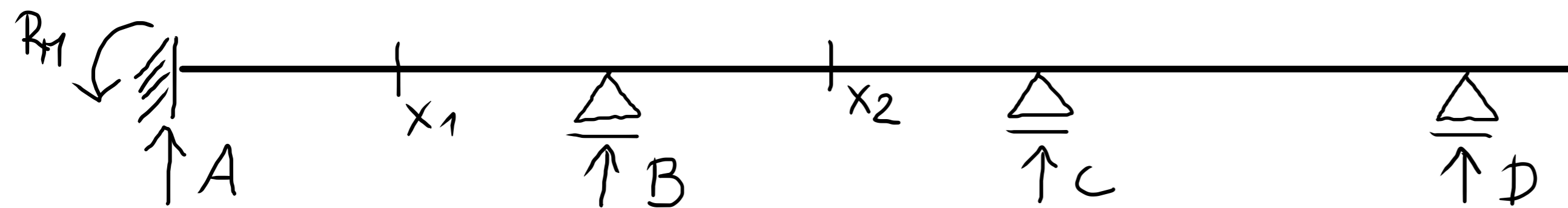

A



B

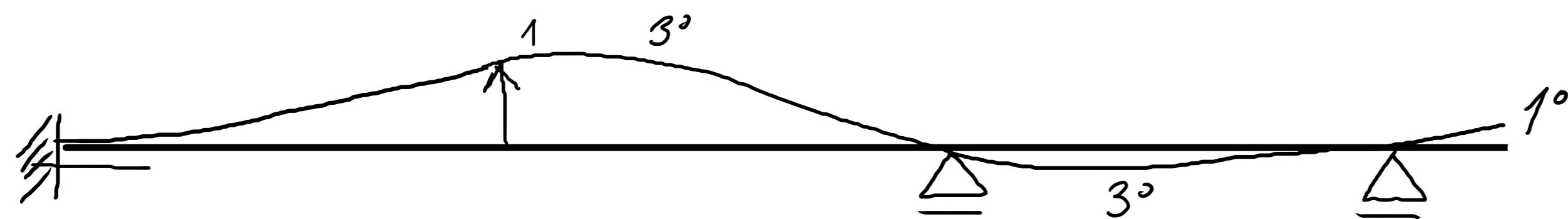

V_{x2}

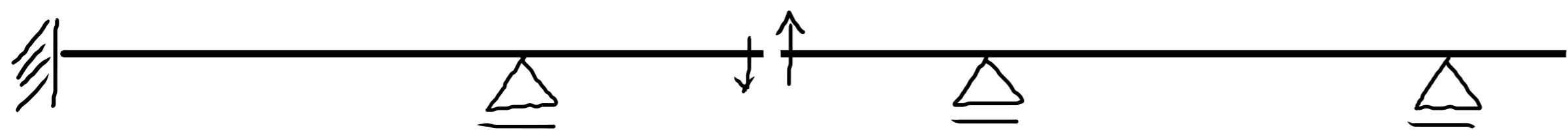

S.U. \rightarrow MAX 1°

S.N. \rightarrow VŽDY 3°

PŘÍČINKOVÉ ČÁRY - SPOJITÝ NOSNÍK

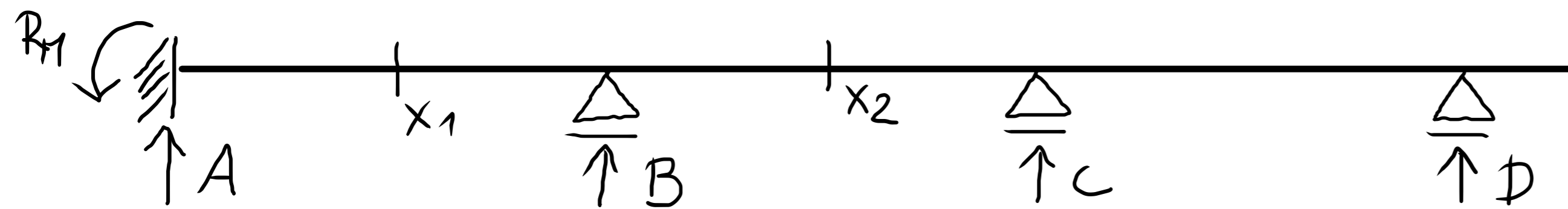

A

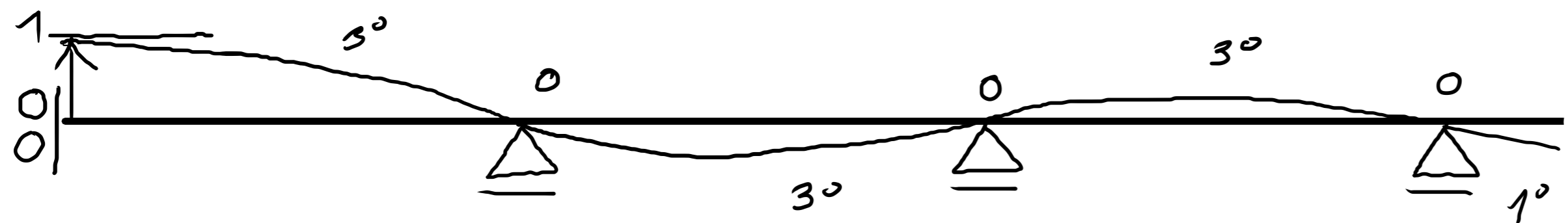

B

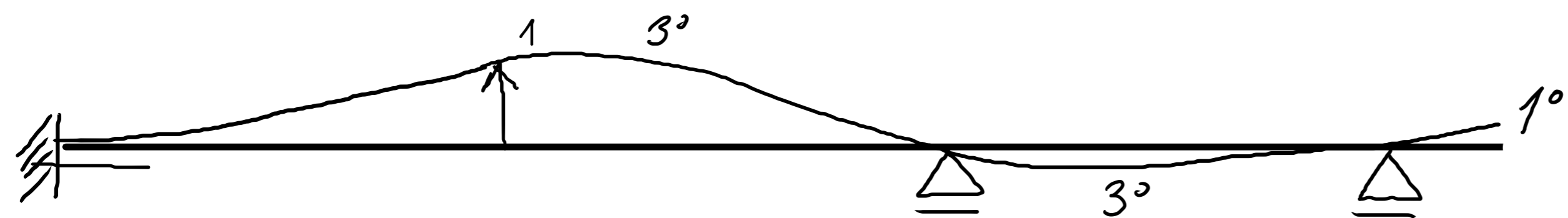

V_{x2}

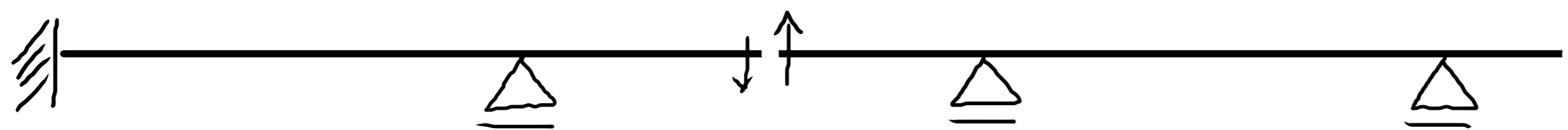

S.U. \rightarrow MAX 1°

S.N. \rightarrow VŽDY 3°

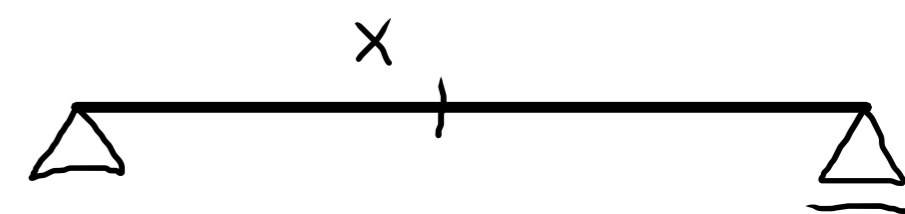

V_x

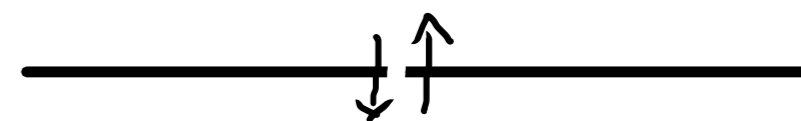

PŘÍČINKOVÉ ČÁRY - SPOJITÝ NOSNÍK

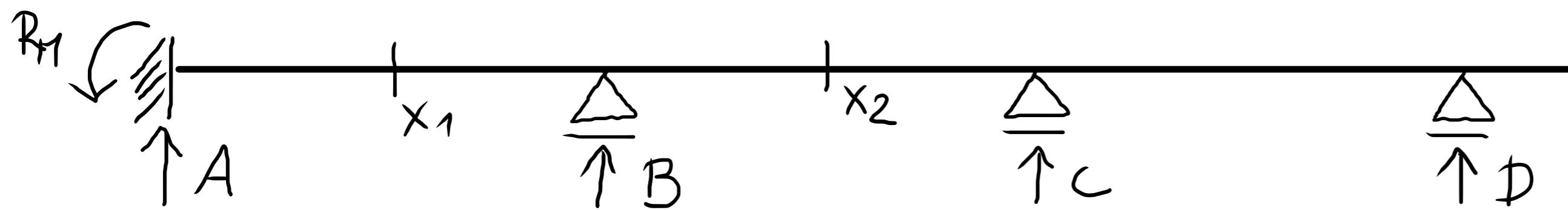

A

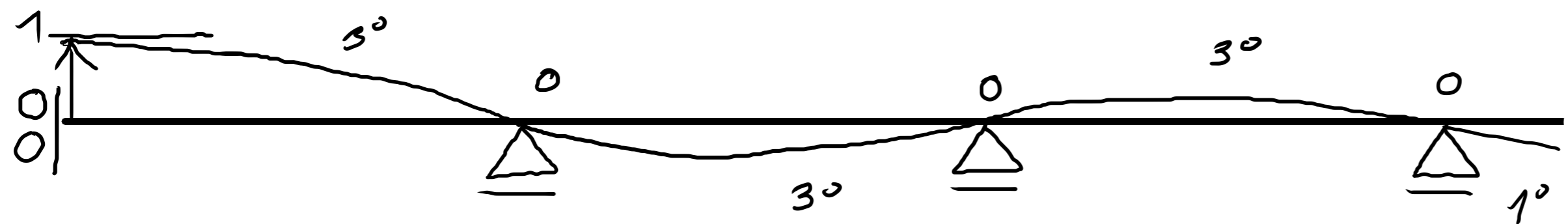

B

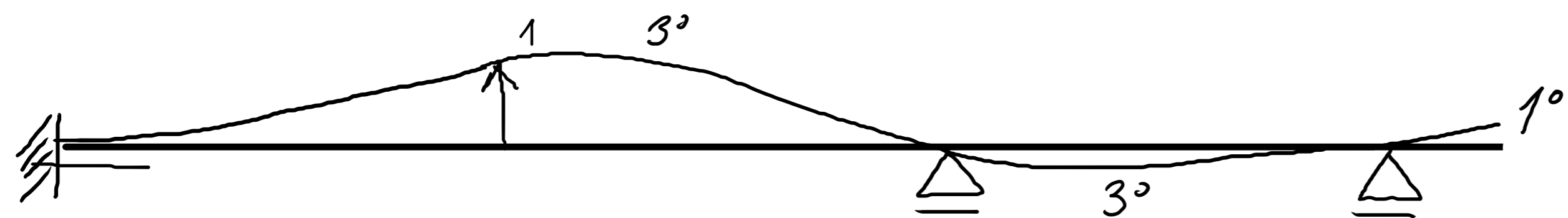

V_{x2}

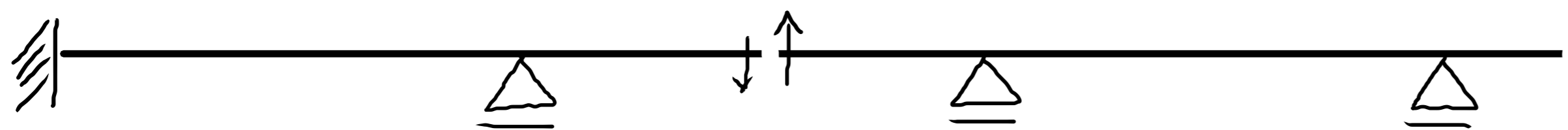

S.U. \rightarrow MAX 1°
 S.N. \rightarrow VŽDY 3°

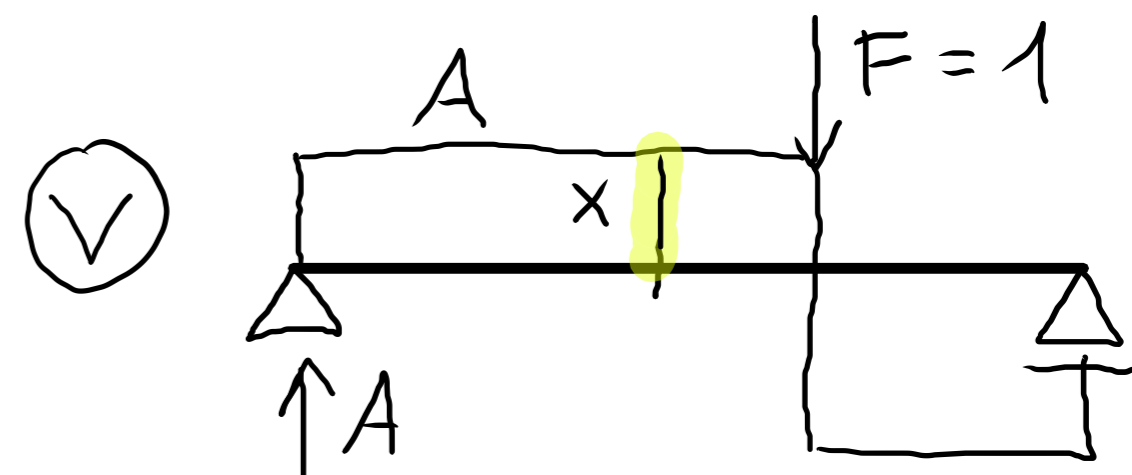

V_x

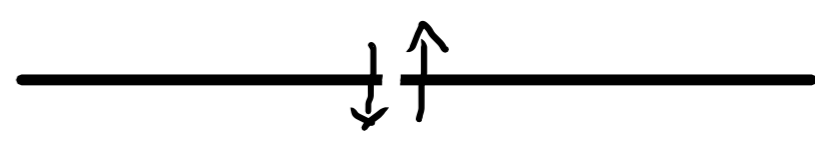

$V_x = A$

PŘÍČINKOVÉ ČÁRY - SPOJITÝ NOSNÍK

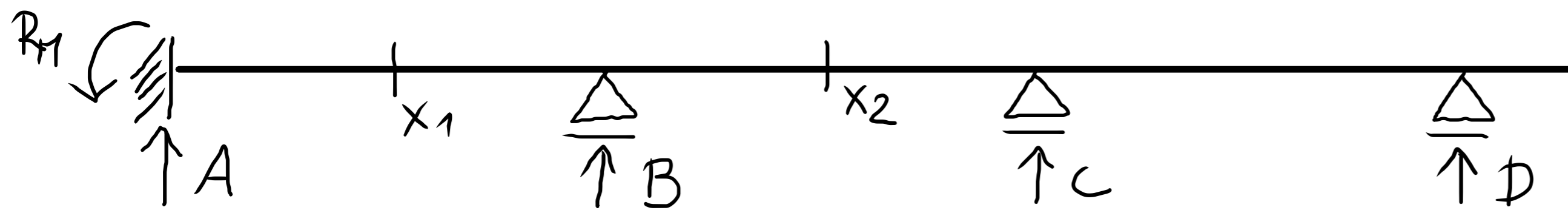

A

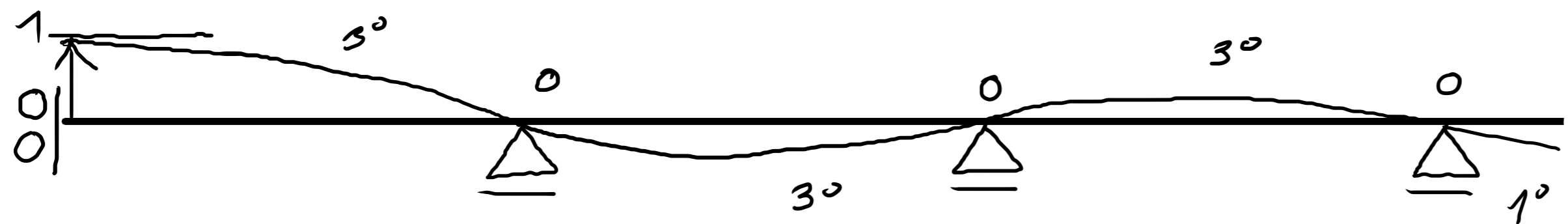

B

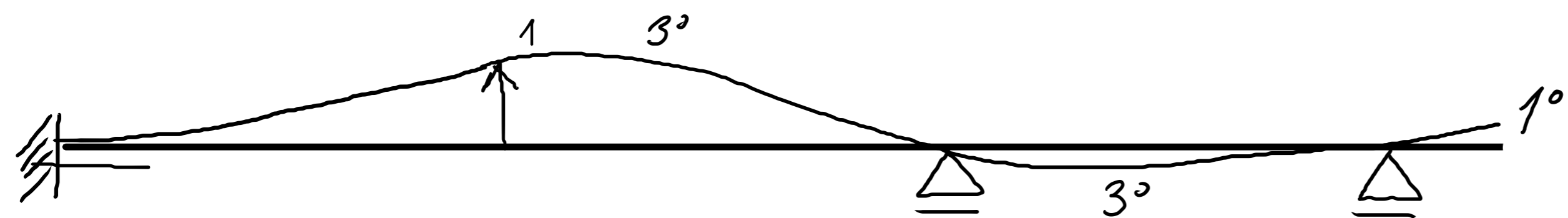

V_{x2}

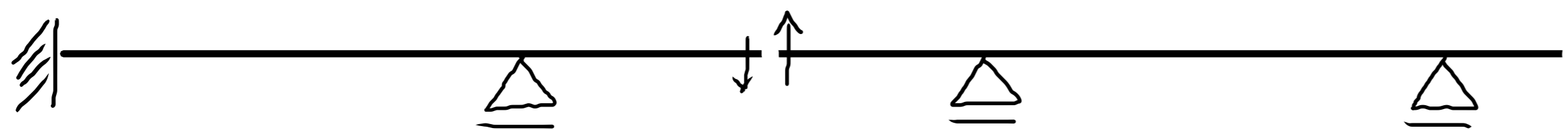

S.U. \rightarrow MAX 1°

S.N. \rightarrow VŽDY 3°

V

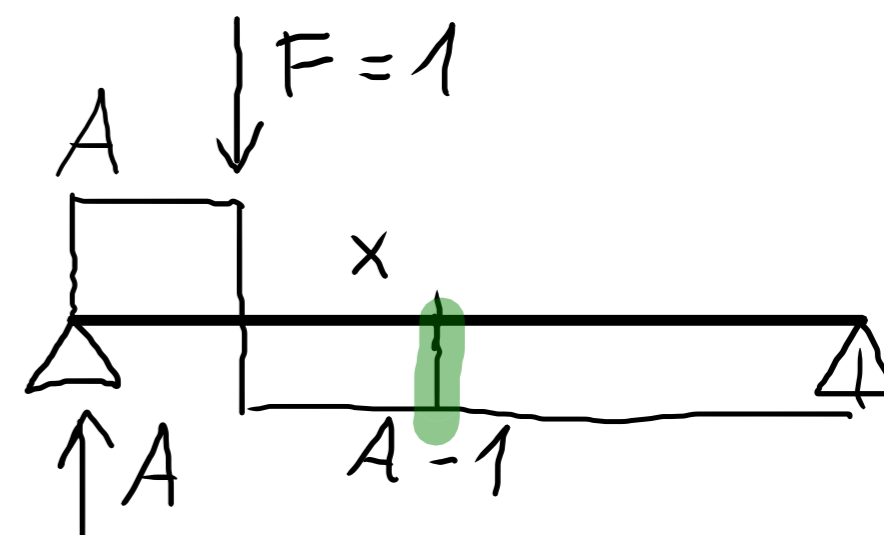

V_x

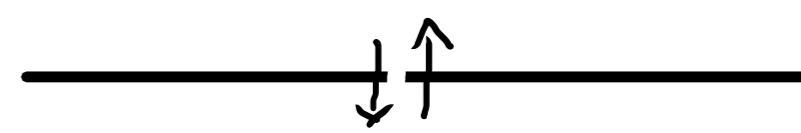

$V_x = A - 1$

$V_x = A$

PŘÍČINKOVÉ ČÁRY - SPOJITÝ NOSNÍK

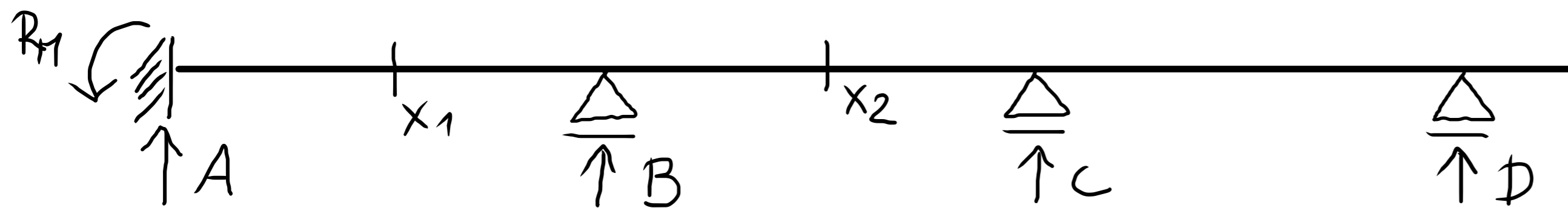

A

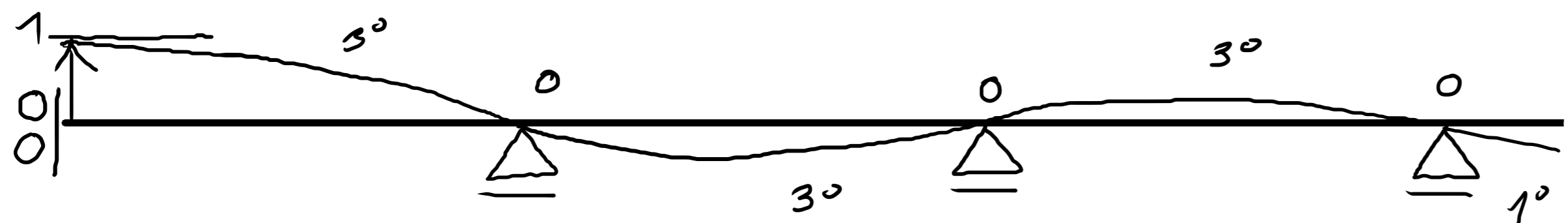

B

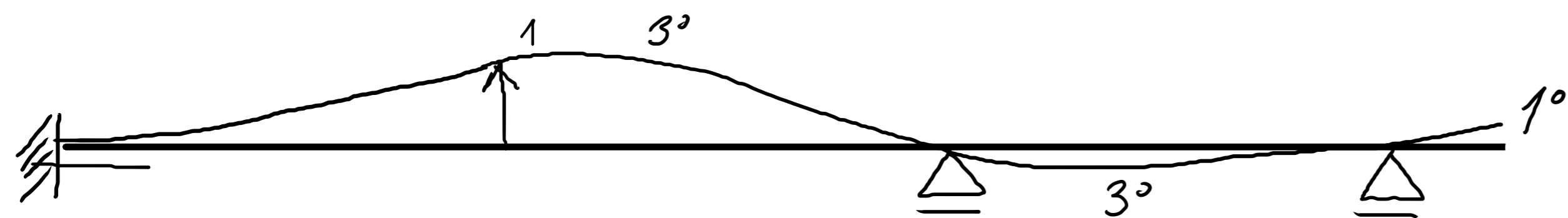

V_{x2}

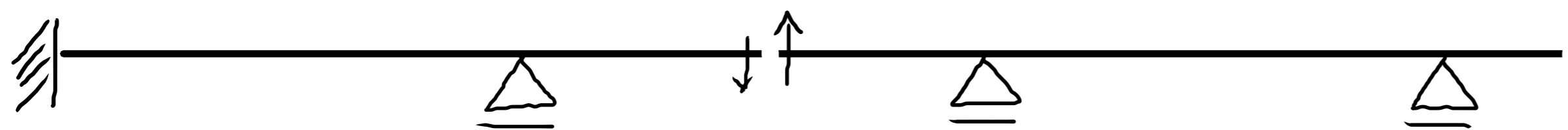

S.U. → MAX 1°

S.N. → VZDY 3°

V

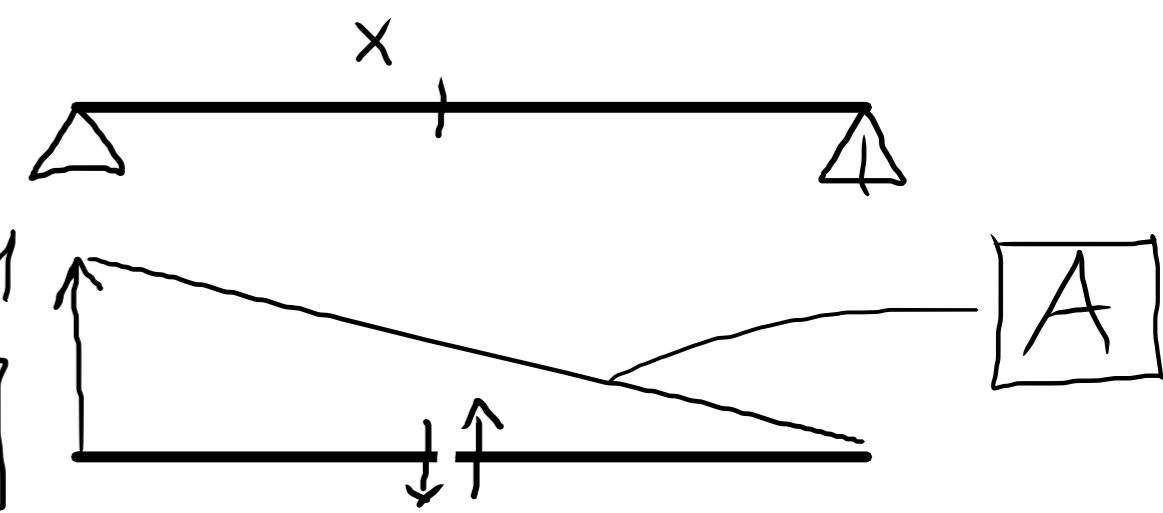

$$V_x = A - 1$$

$$V_x = A$$

PŘÍČINKOVÉ ČÁRY - SPOJITÝ NOSNÍK

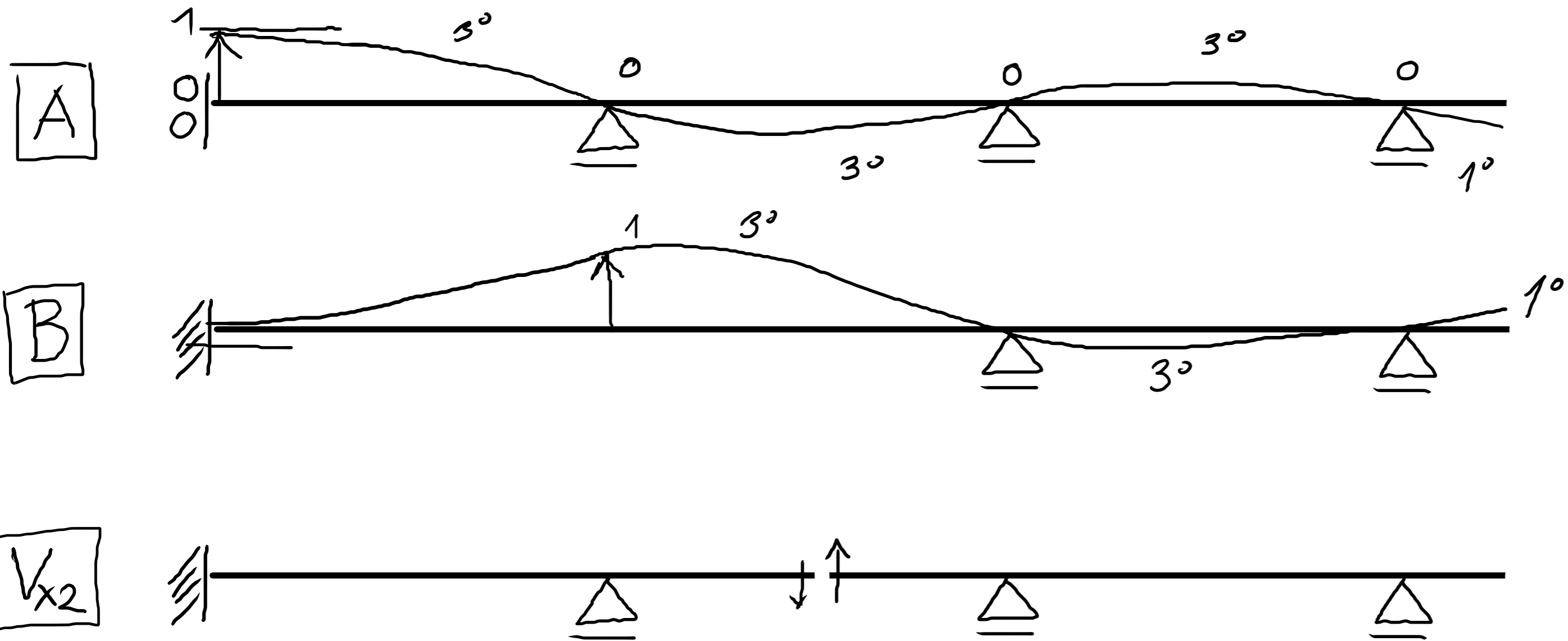
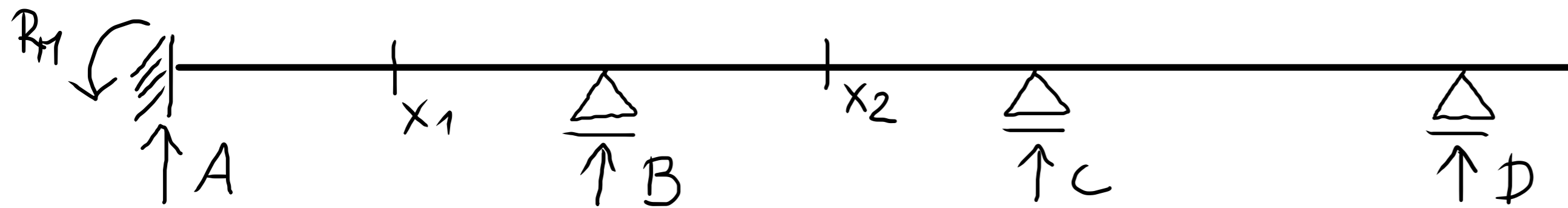

S.U. \rightarrow MAX 1°
 S.N. \rightarrow VŽDY 3°

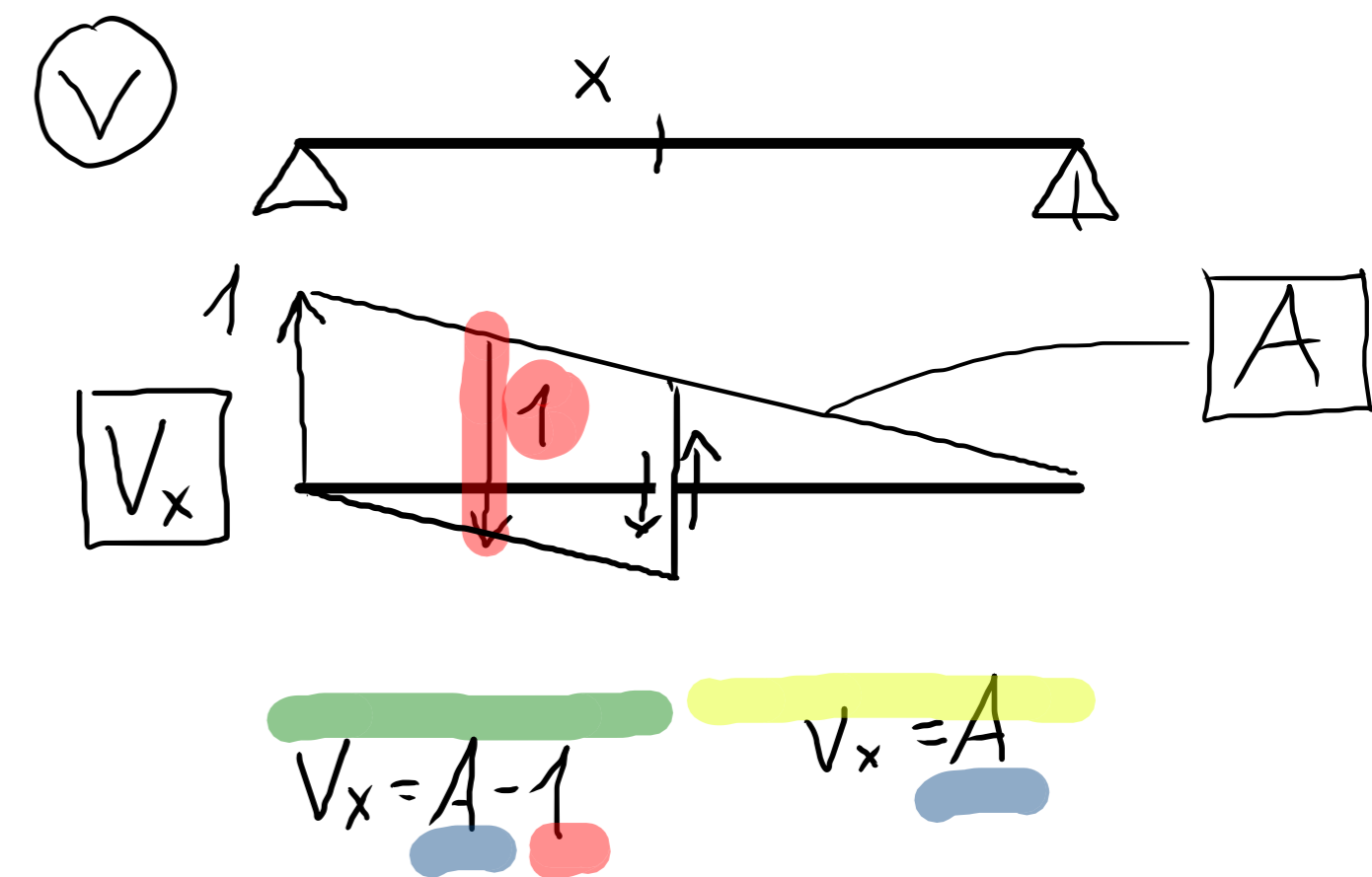

PŘÍČINKOVÉ ČÁRY - SPOJITÝ NOSNÍK

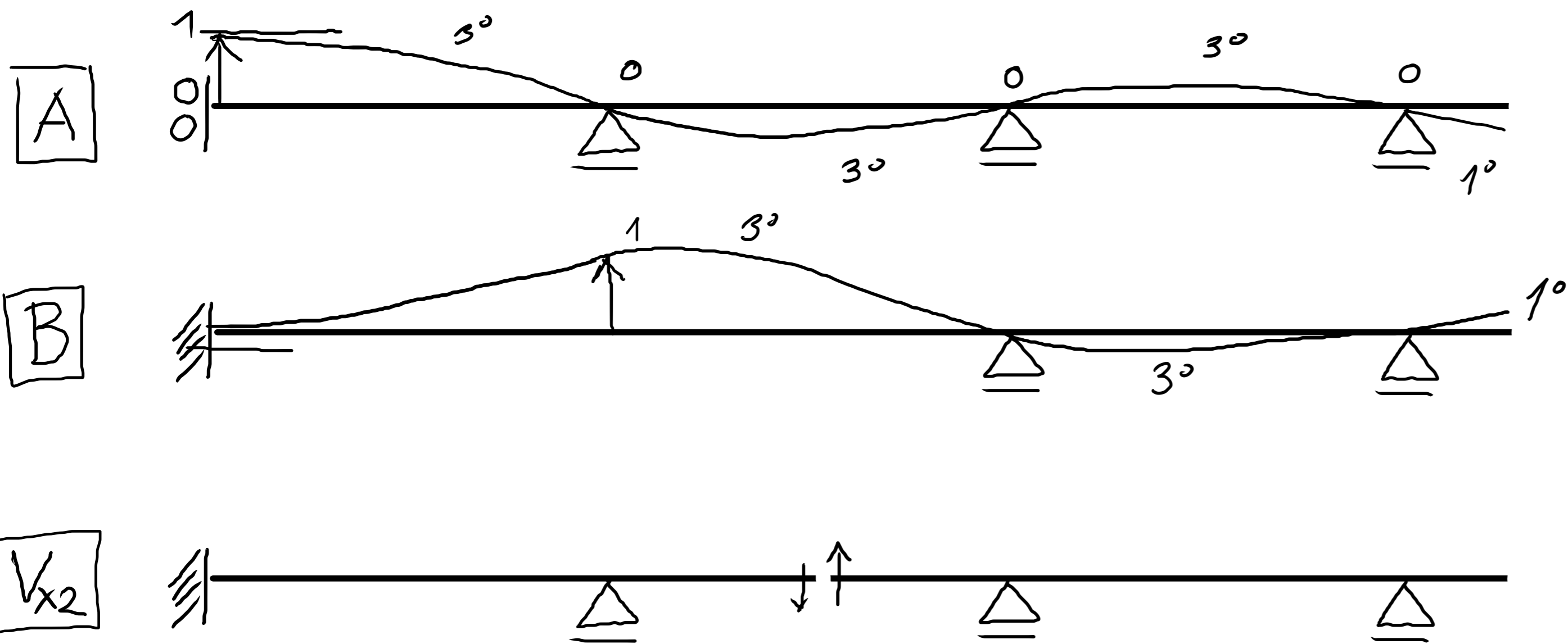
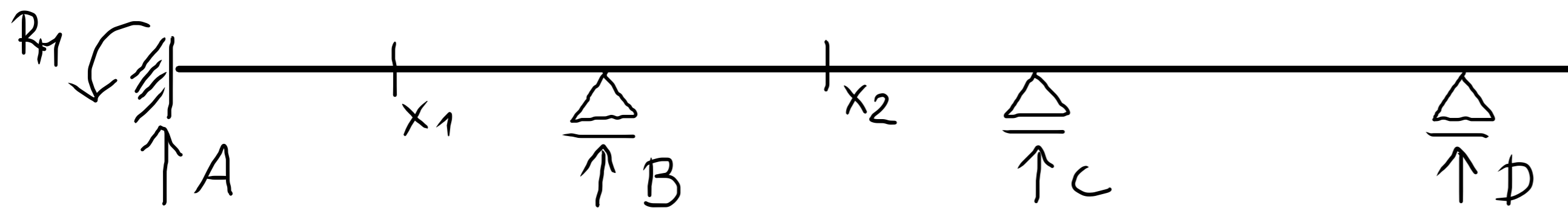

S.U. \rightarrow MAX 1°

S.N. \rightarrow VŽDY 3°

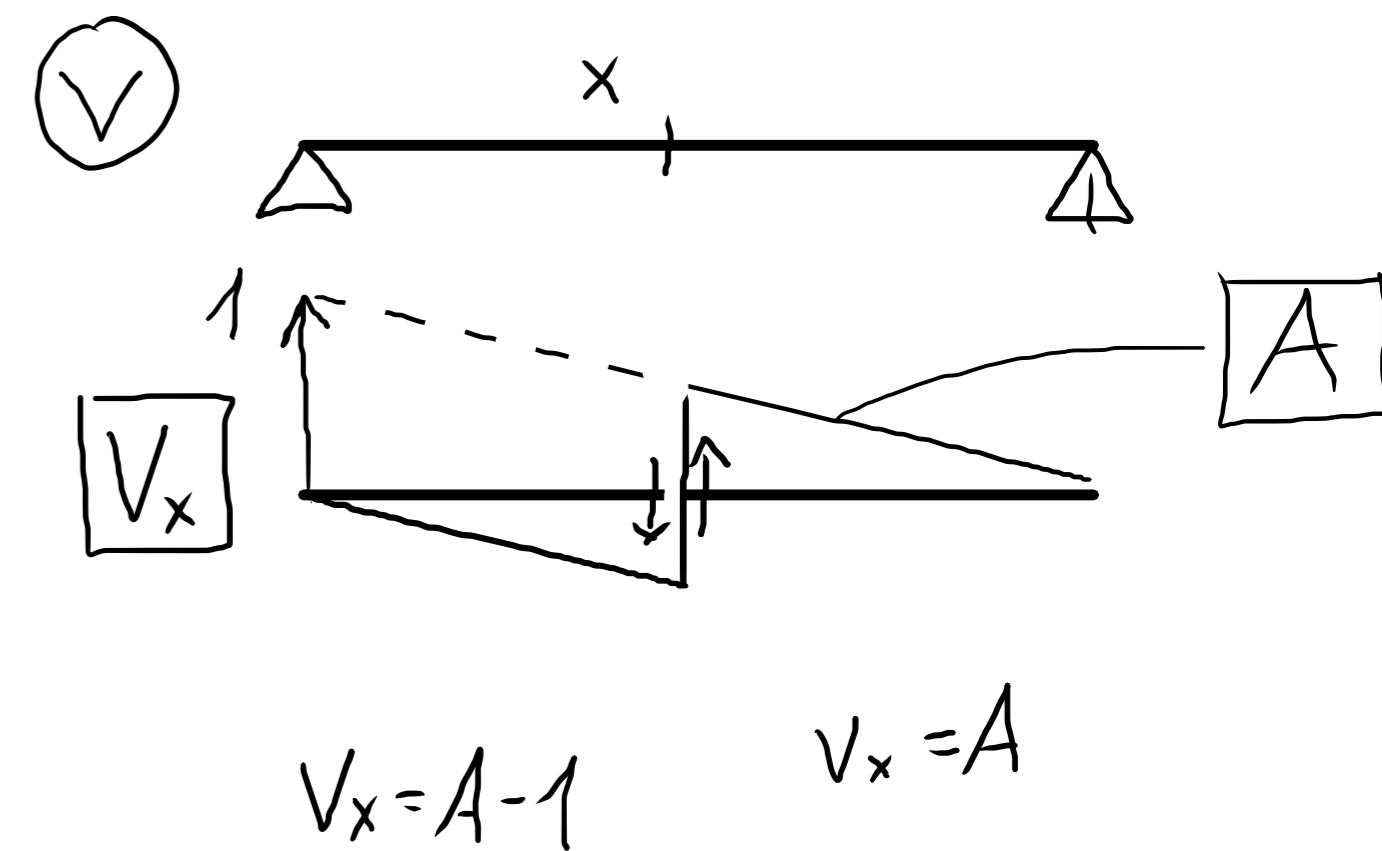

PŘÍČINKOVÉ ČÁRY - SPOJITÝ NOSNÍK

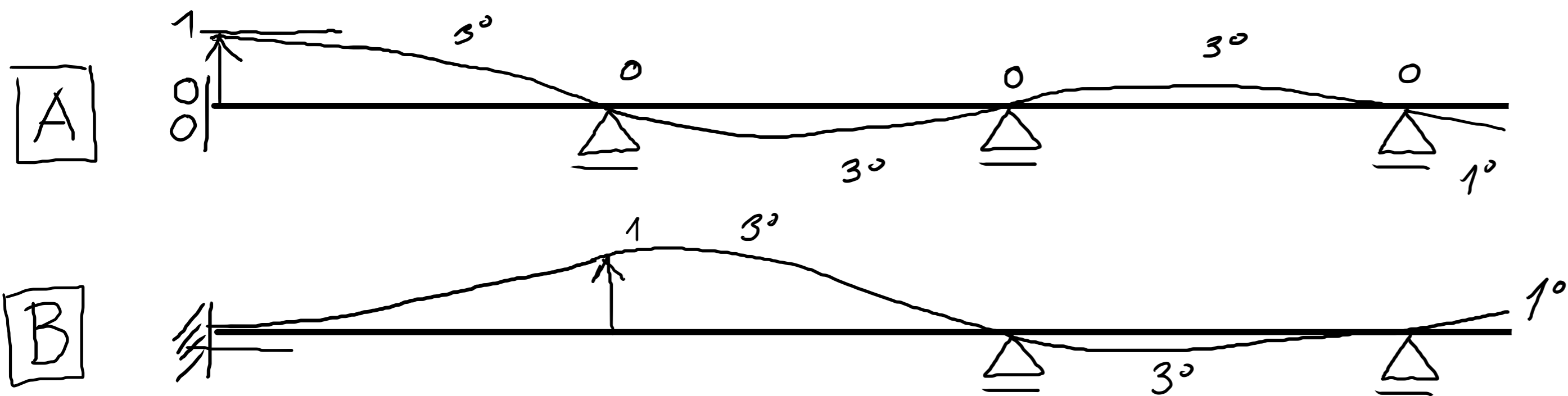
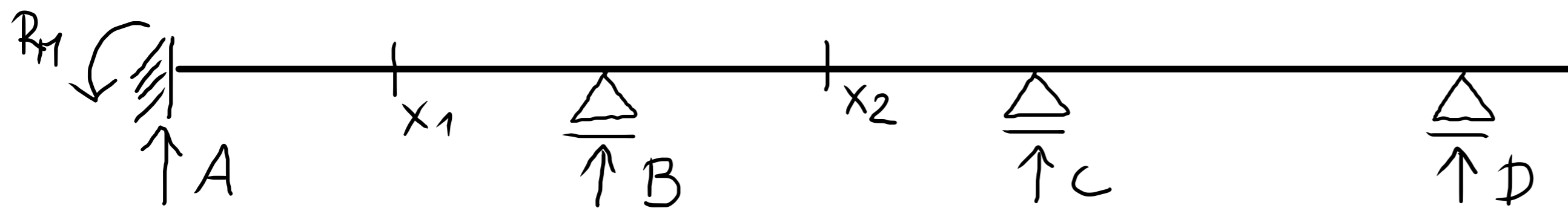

$\downarrow F=1 \quad V_x = A+B$

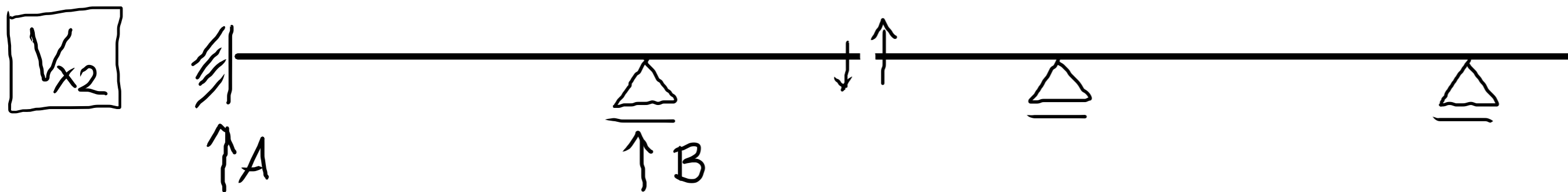

S.U. \rightarrow MAX 1°
 S.N. \rightarrow VŽDY 3°

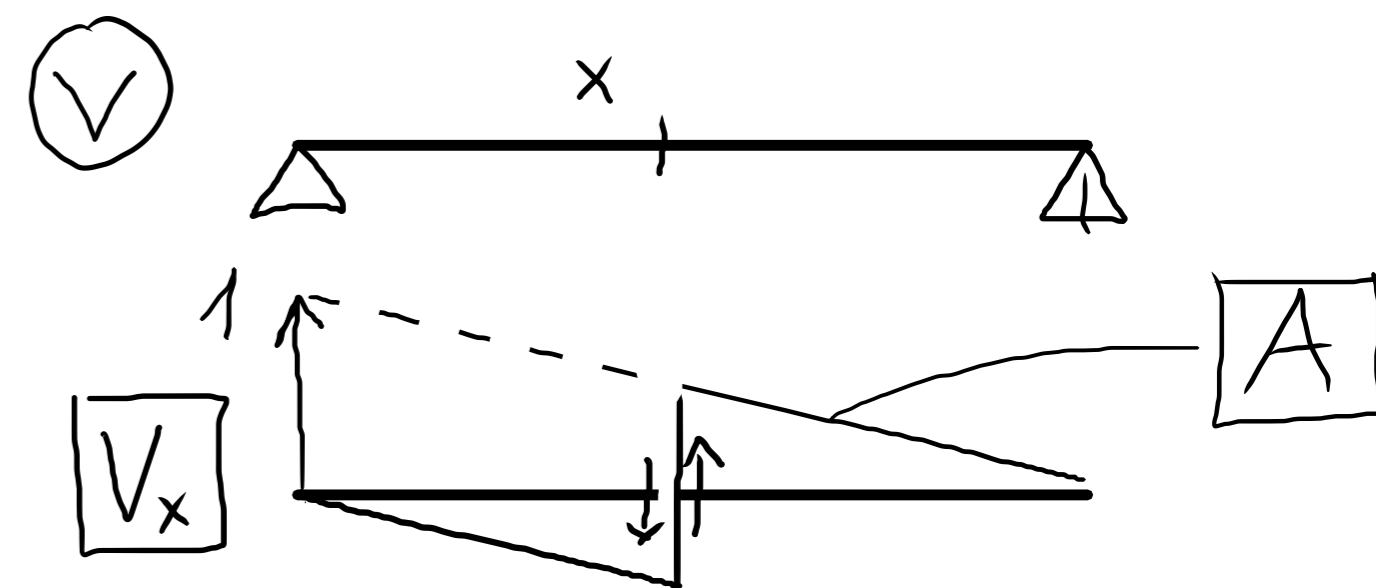

$V_x = A-1 \quad V_x = A$

PŘÍČINKOVÉ ČÁRY - SPOJITÝ NOSNÍK

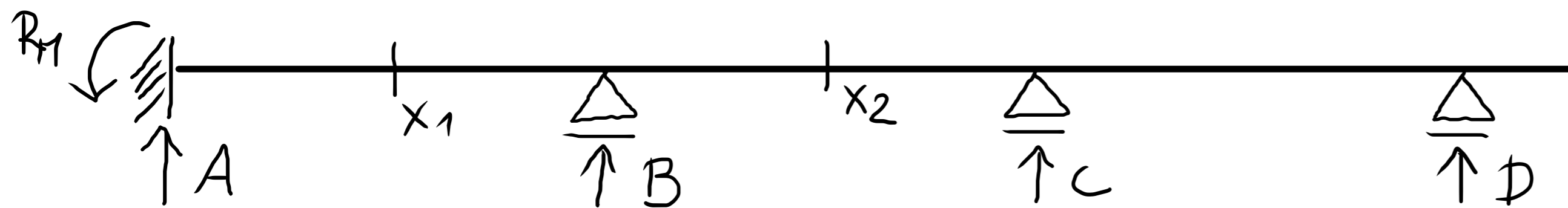

A

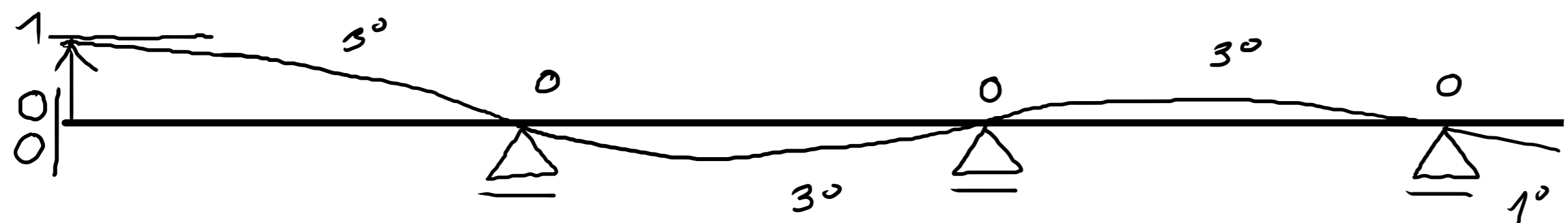

B

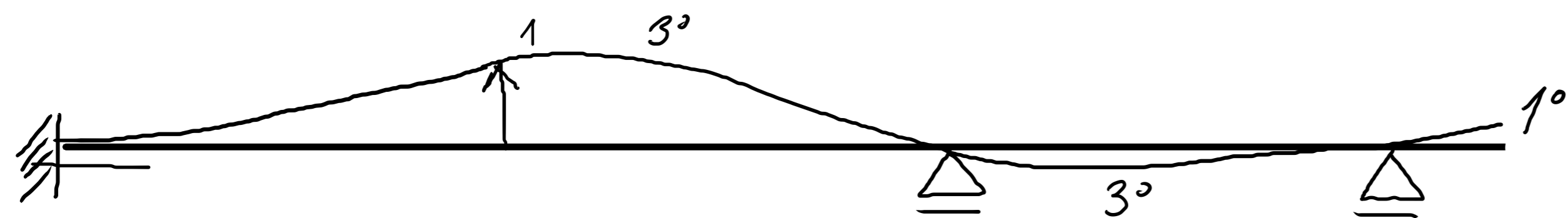

$$V_x = A + B - 1$$

$$\downarrow F = 1 \quad V_x = A + B$$

V_{x2}

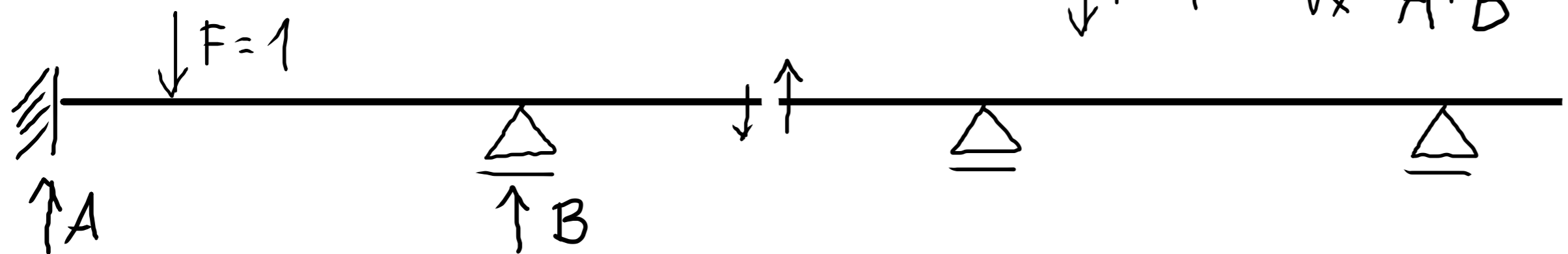

S.U. \rightarrow MAX 1°

S.N. \rightarrow VŽDY 3°

V

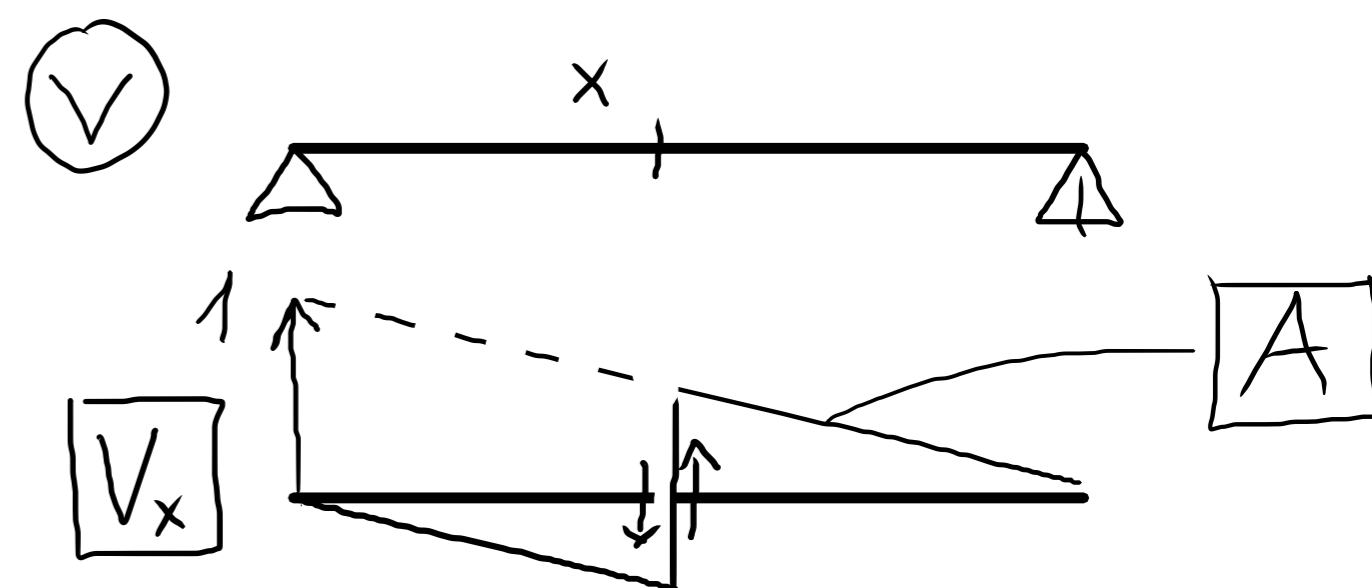

$$V_x = A - 1$$

$$V_x = A$$

PŘÍČINKOVÉ ČÁRY - SPOJITÝ NOSNÍK

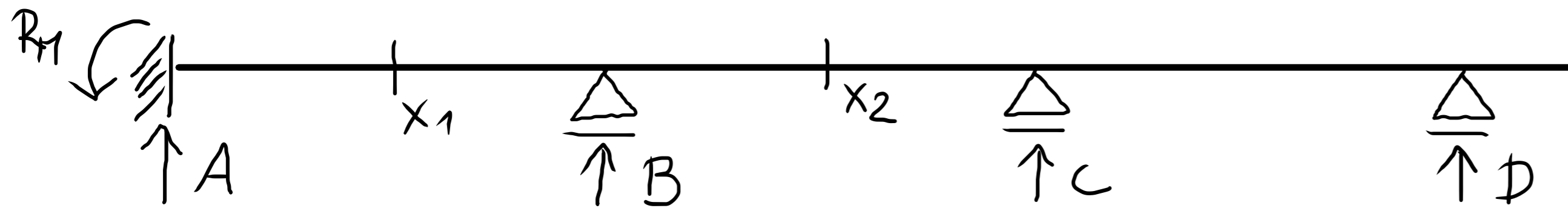

A

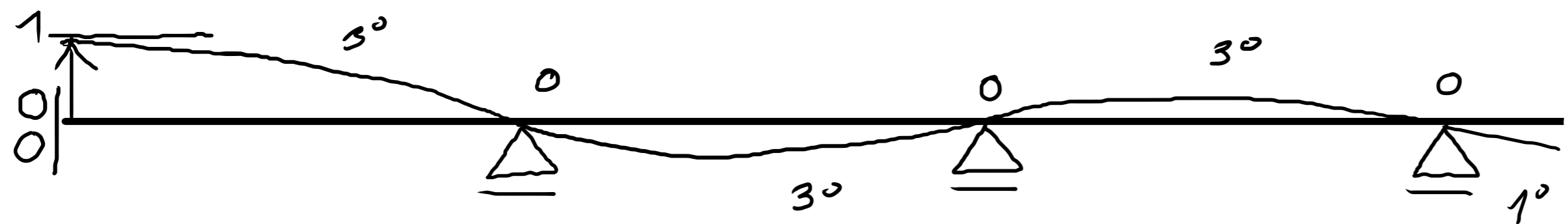

B

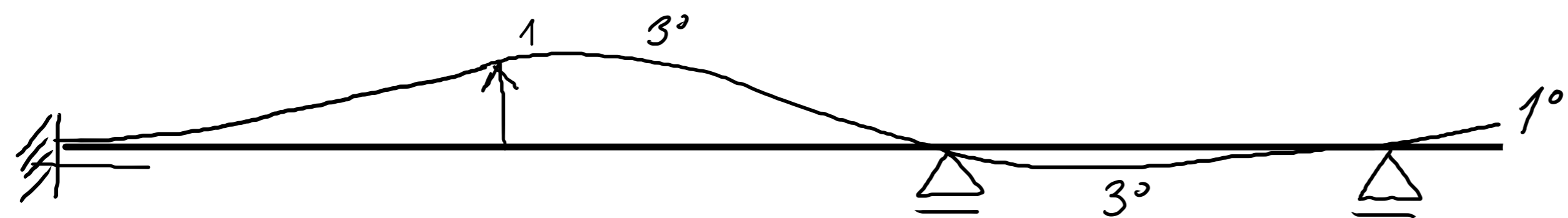

V_{x2}

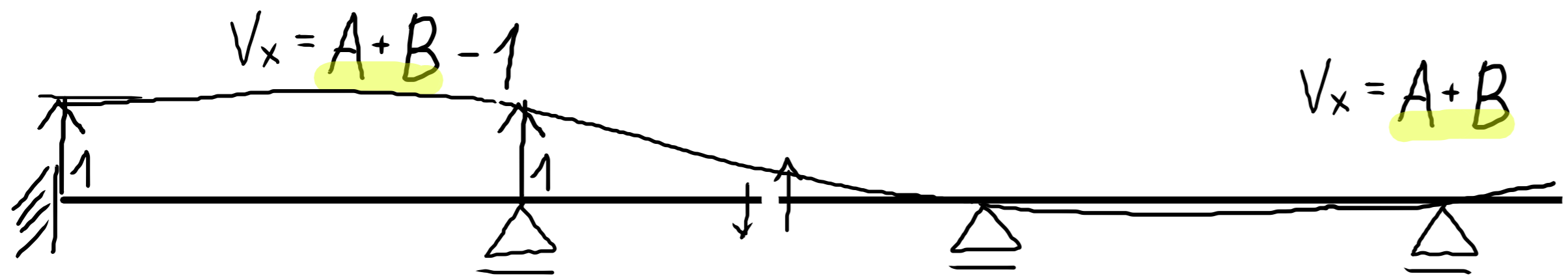

S.U. → MAX 1°
S.N. → VZDY 3°

V

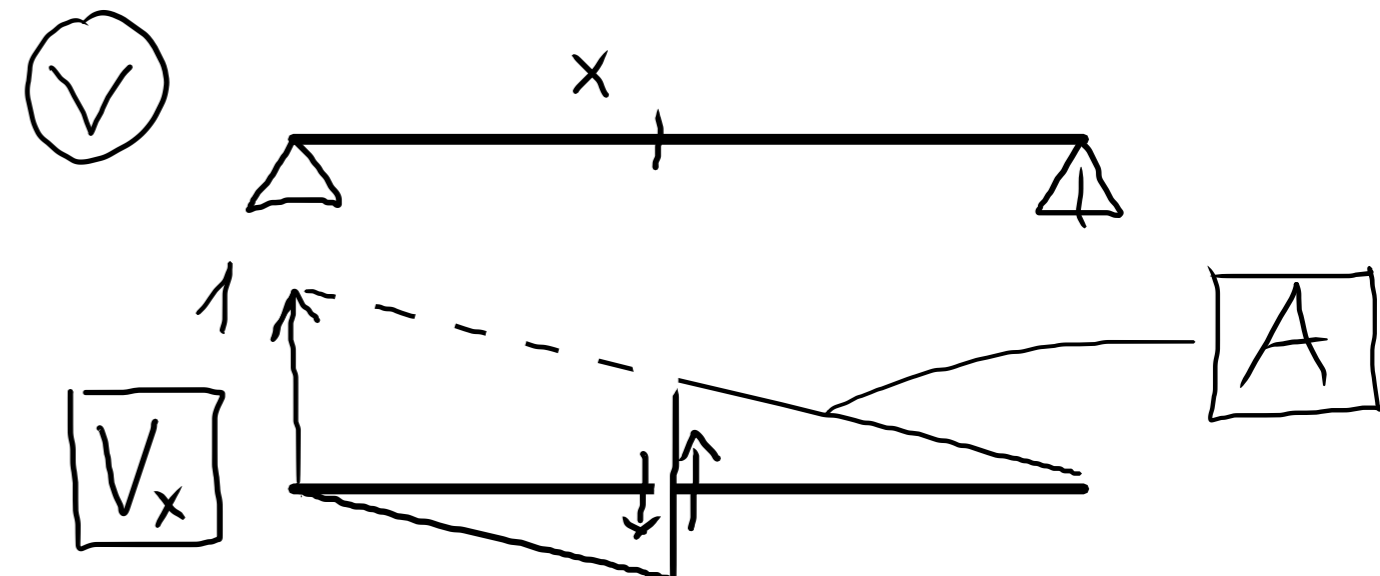

$V_x = A - 1$ $V_x = A$

PŘÍČINKOVÉ ČÁRY - SPOJITÝ NOSNÍK

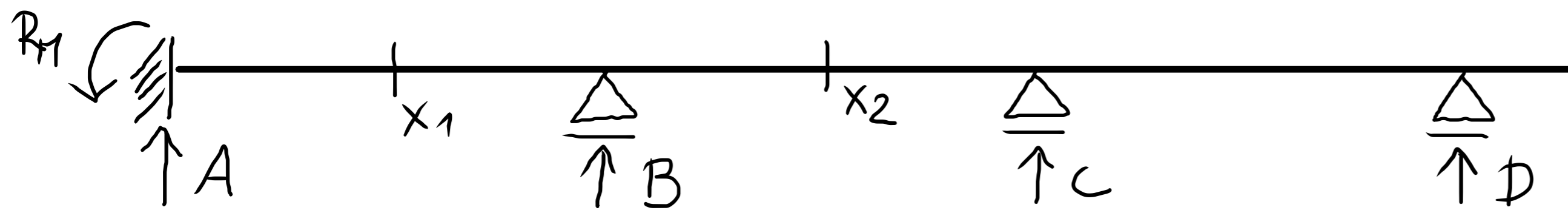

A

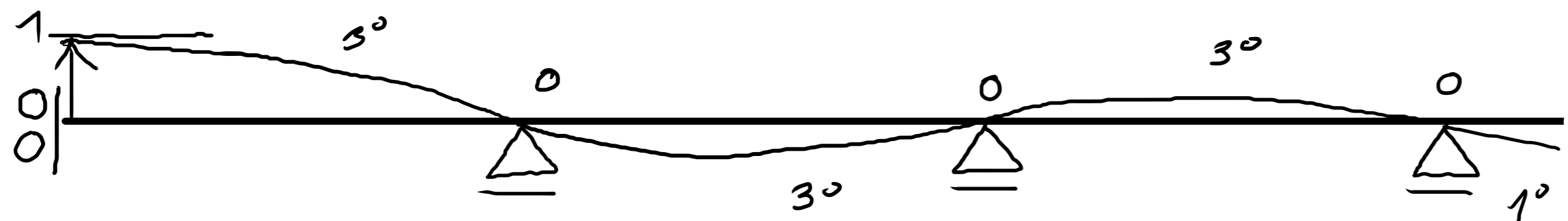

B

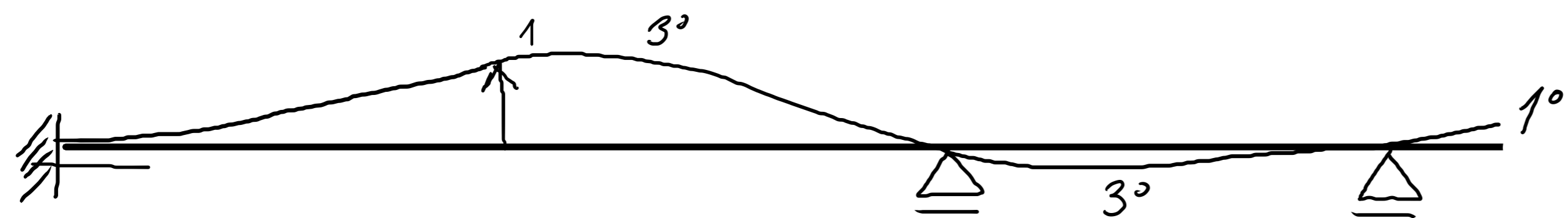

V_{x2}

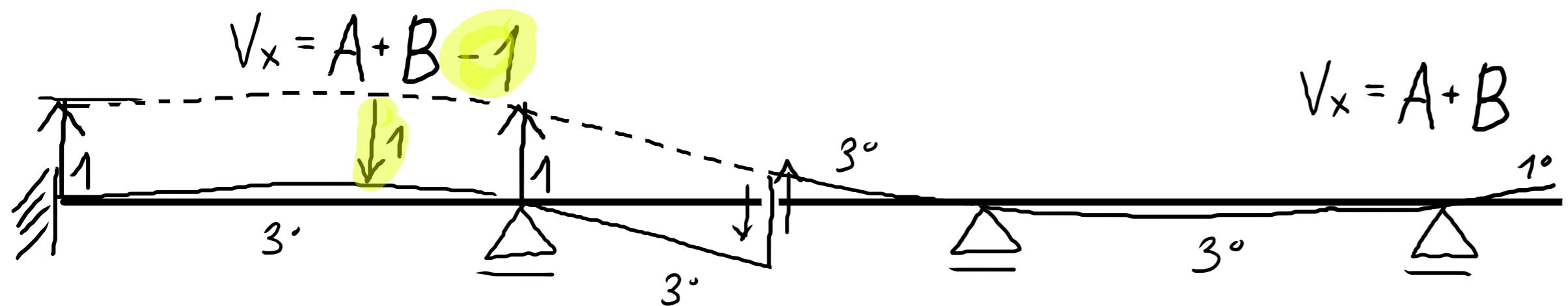

S.U. \rightarrow MAX 1°

S.N. \rightarrow VŽDY 3°

V

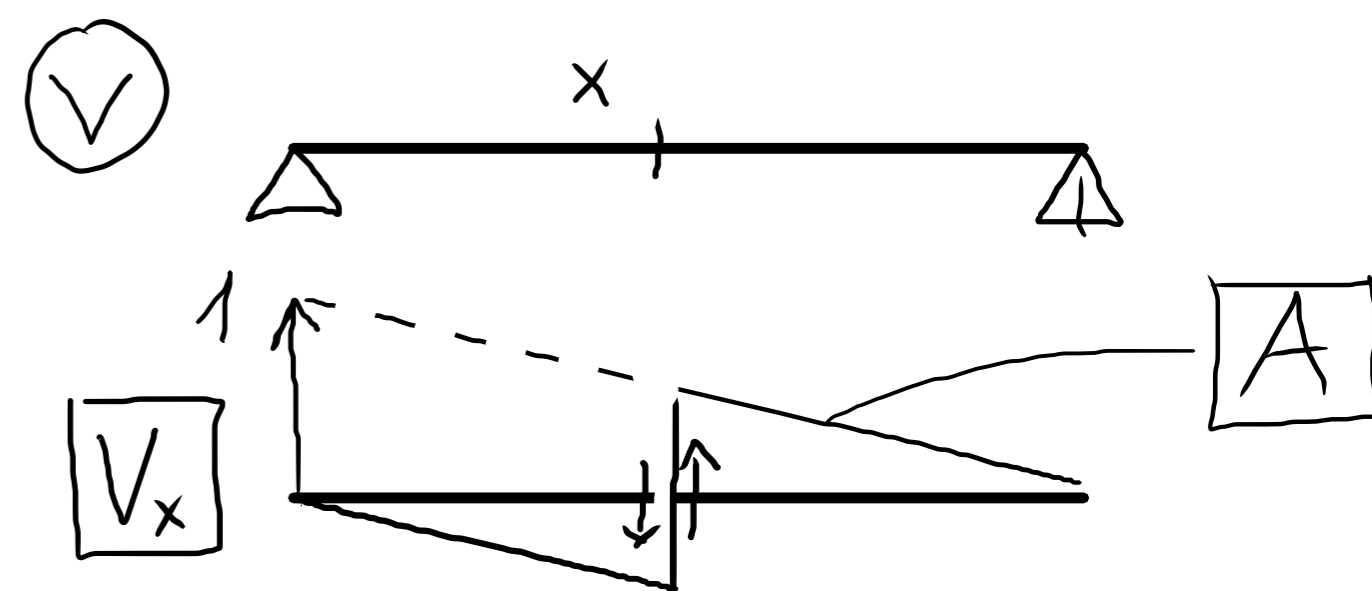

$V_x = A - 1$

$V_x = A$

PŘÍČINKOVÉ ČÁRY - SPOJITÝ NOSNÍK

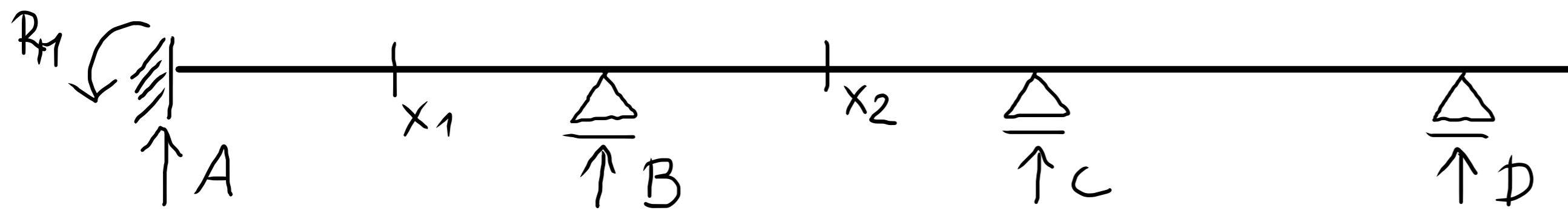

A

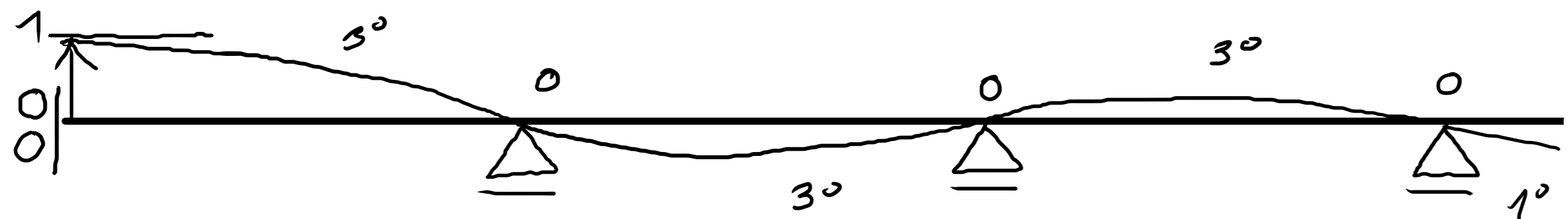

B

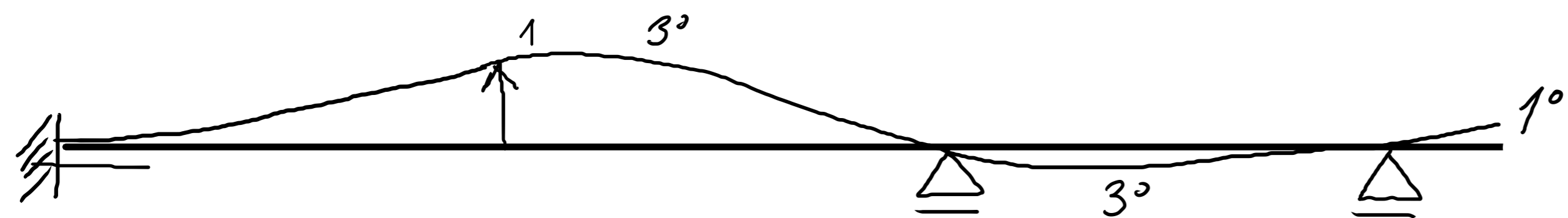

V_{x2}

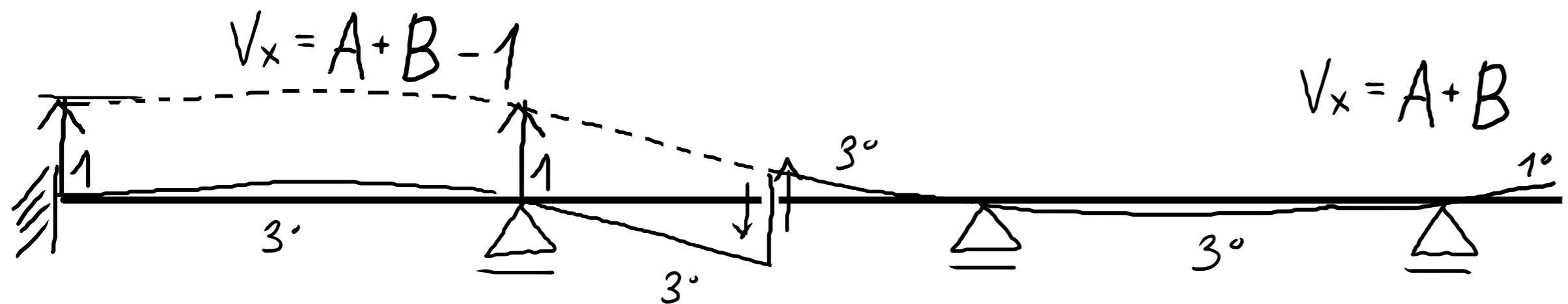

M_{x2}

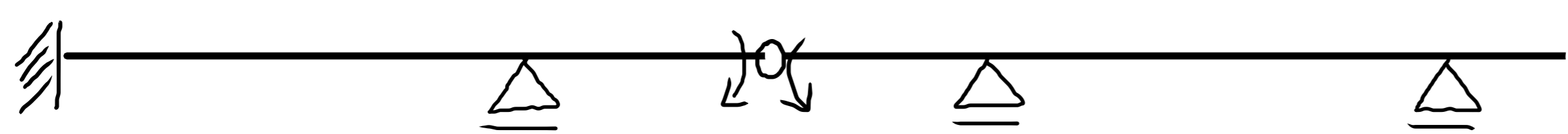

S.U. → MAX 1°

S.N. → VŽDY 3°

V

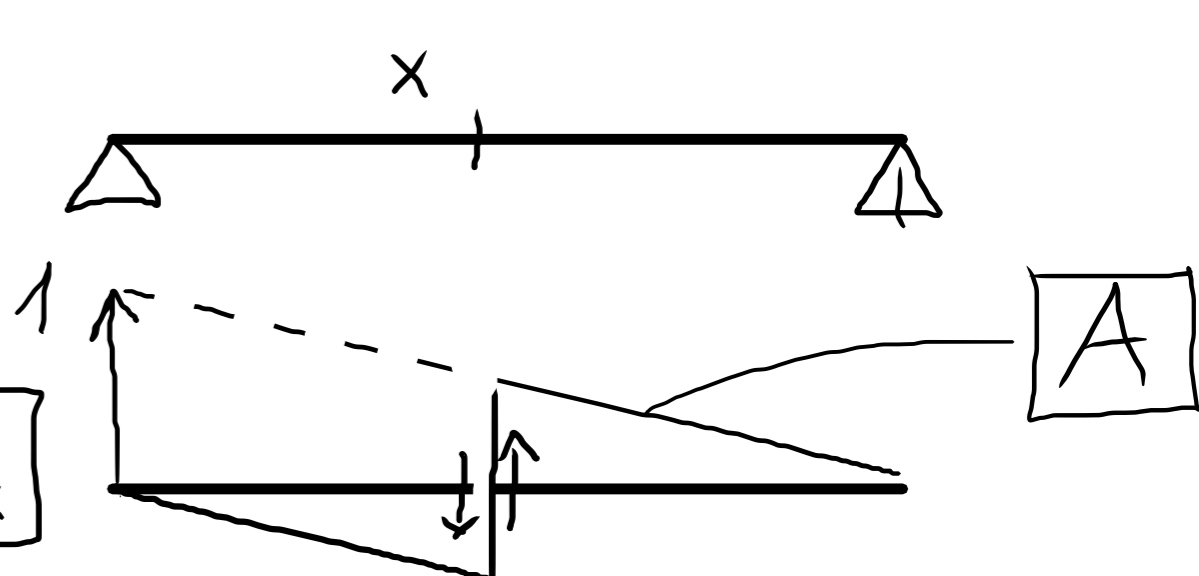

$V_x = A - 1$

$V_x = A$

PŘÍČINKOVÉ ČÁRY - SPOJITÝ NOSNÍK

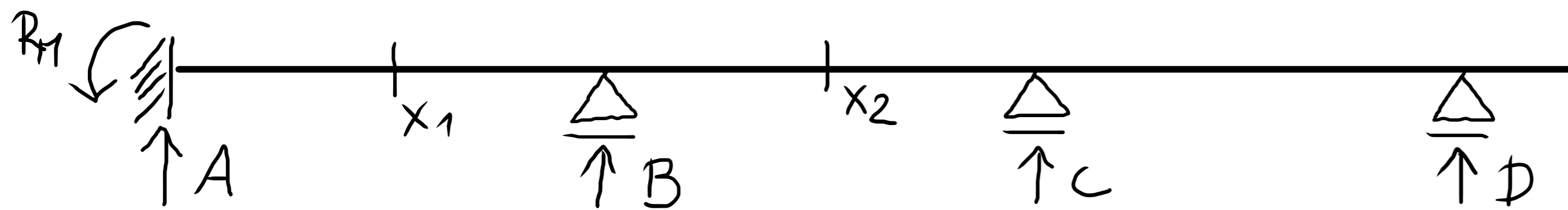

A

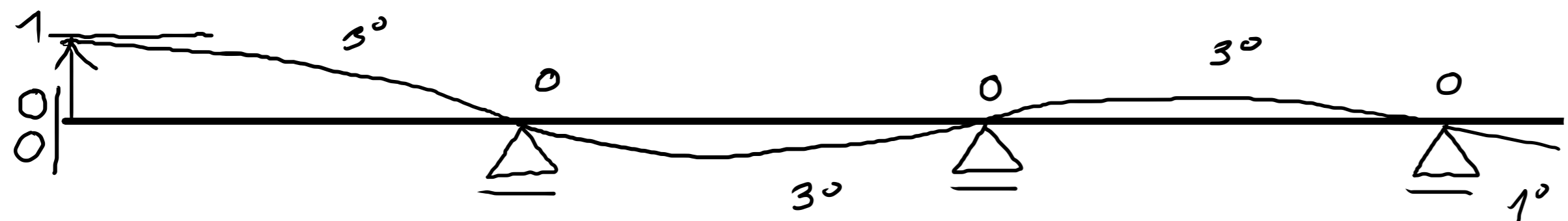

B

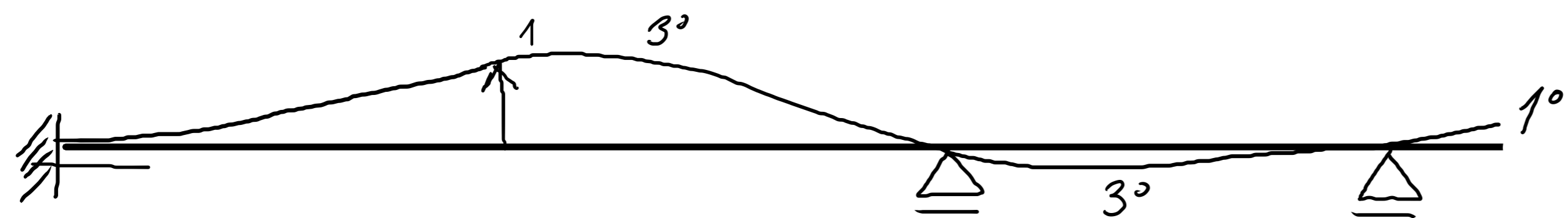

V_{x2}

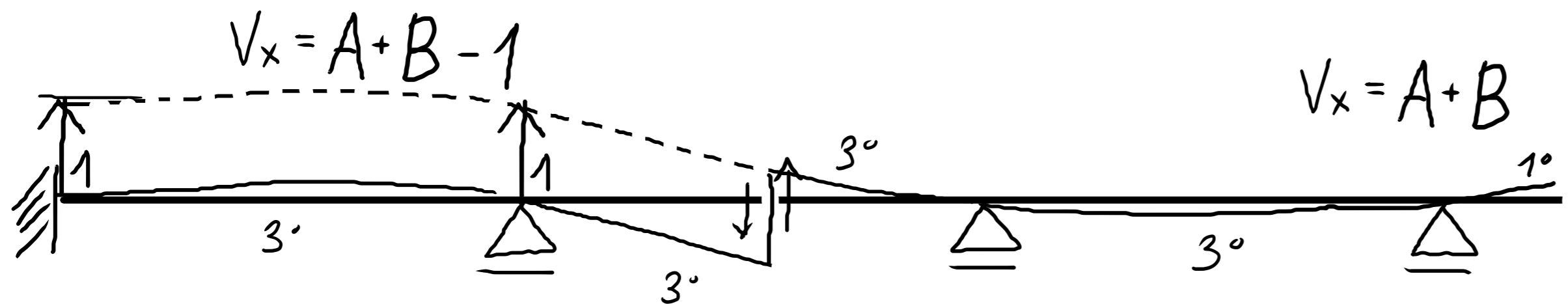

M_{x2}

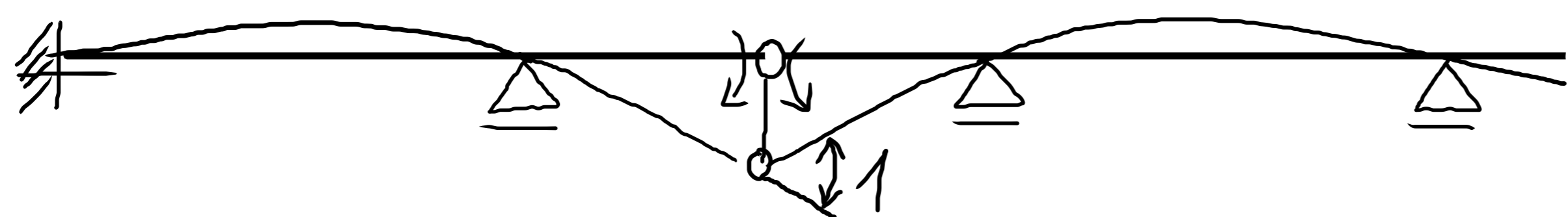

S.U. → MAX 1°

S.N. → VZDY 3°

V

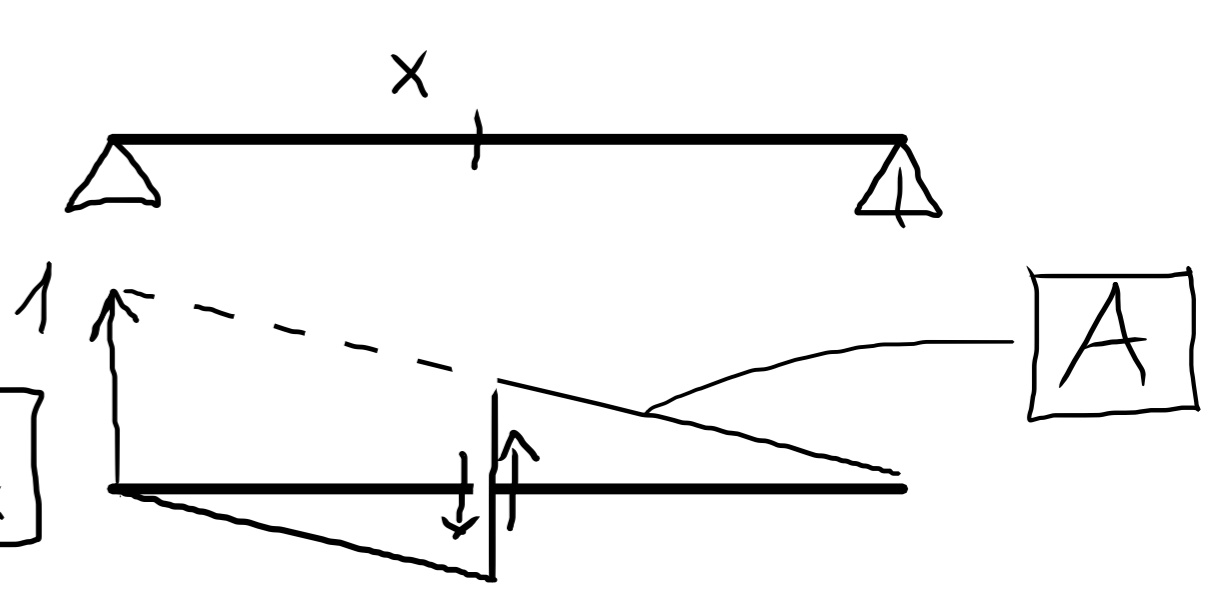

$V_x = A - 1$

$V_x = A$

PŘÍČINKOVÉ ČÁRY - SPOJITÝ NOSNÍK

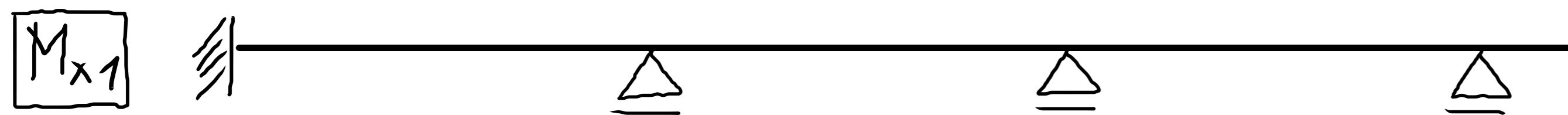
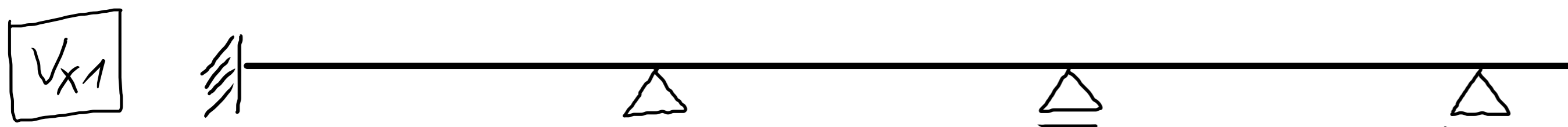
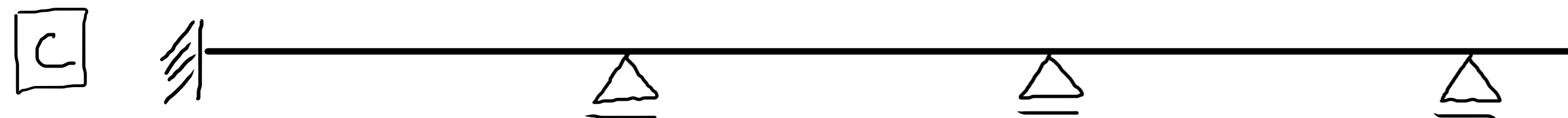
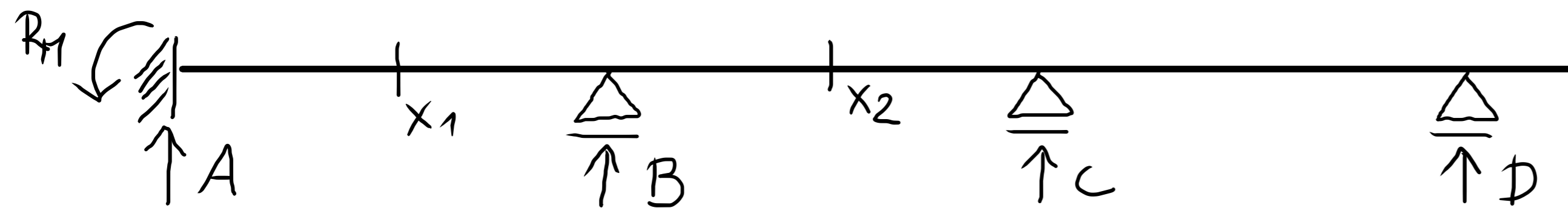

S.U. \rightarrow MAX 1°

S.N. \rightarrow VŽDY 3°

PŘÍČINKOVÉ ČÁRY - SPOJITÝ NOSNÍK

S.U. \rightarrow MAX 1°

S.N. \rightarrow VŽDY 3°

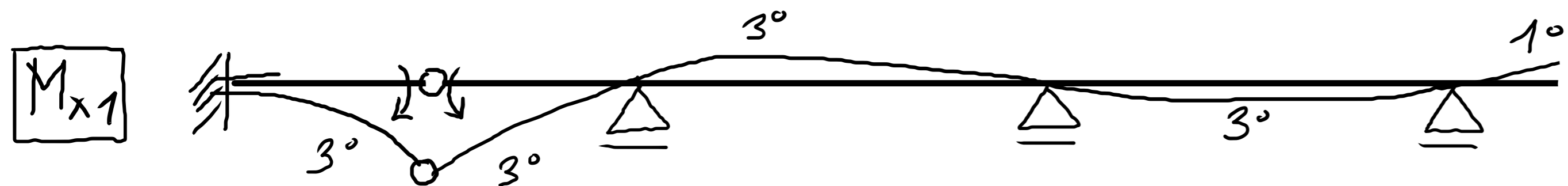
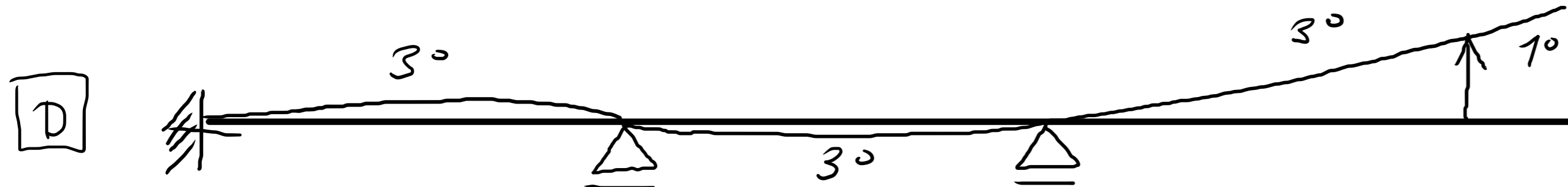
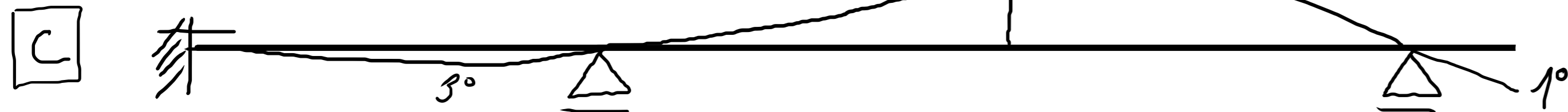
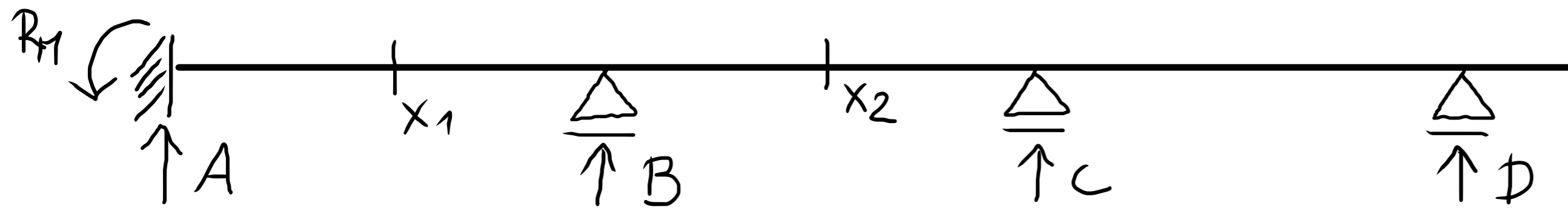

PŘÍČINKOVÉ ČÁRY - VÝPOČET VELIČIN

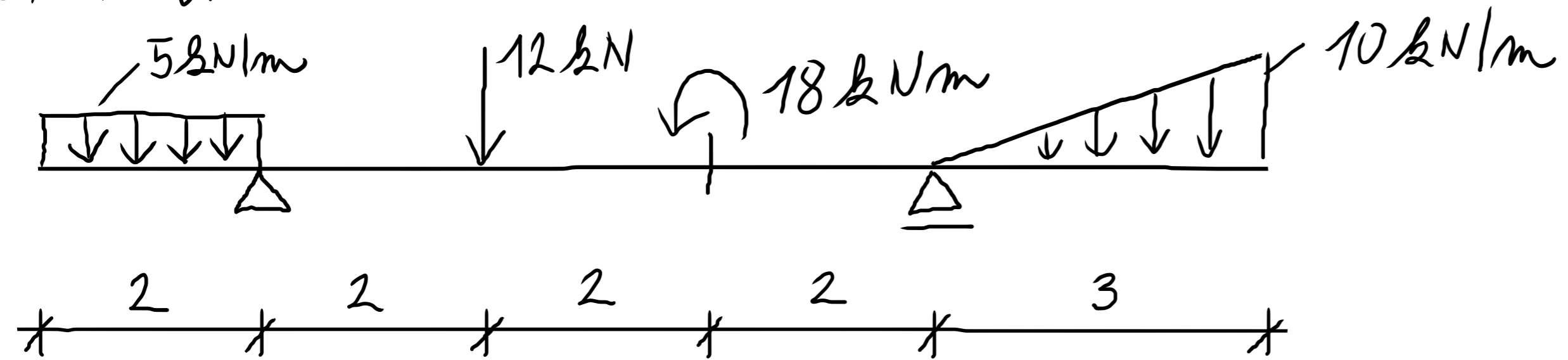

PŘÍČINKOVÉ ČÁRY - VÝPOČET VELIČIN

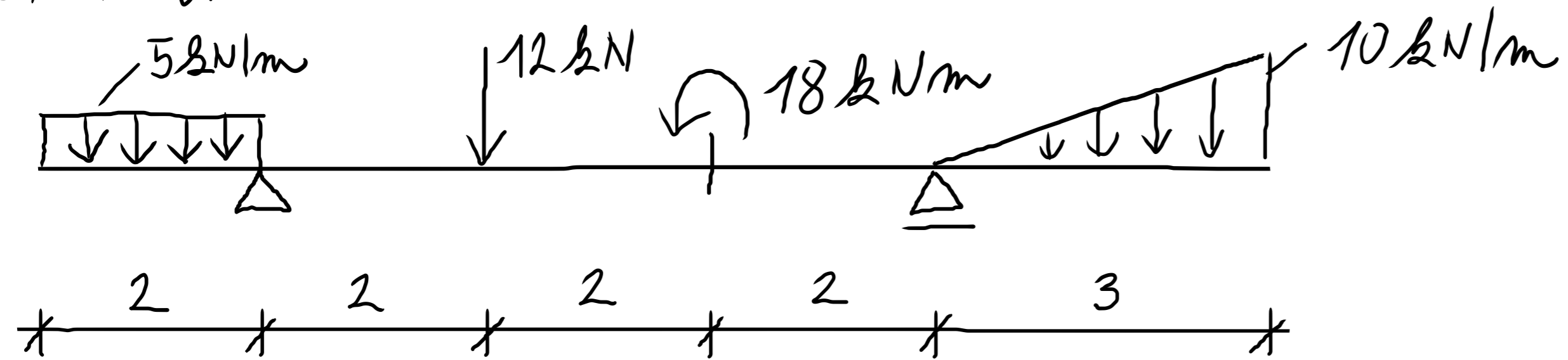

VYPOČÍTEJTE:
- REAKCE
- $V(x/2)$; $M(x/2)$

PŘÍČINKOVÉ ČÁRY - VÝPOČET VELIČIN

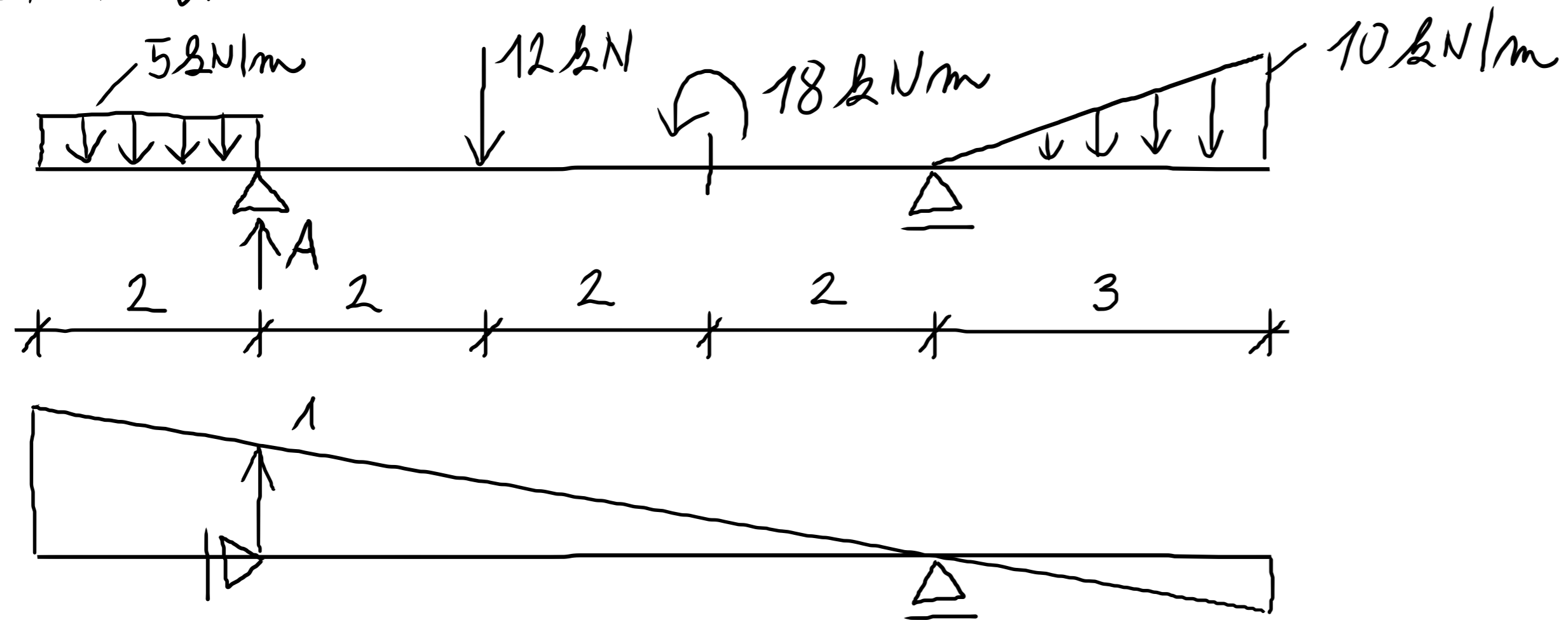

VYPOČÍTEJTE:
- REAKCE
- $V(x/2)$; $M(x/2)$

A

PŘÍČINKOVÉ ČÁRY - VÝPOČET VELIČIN

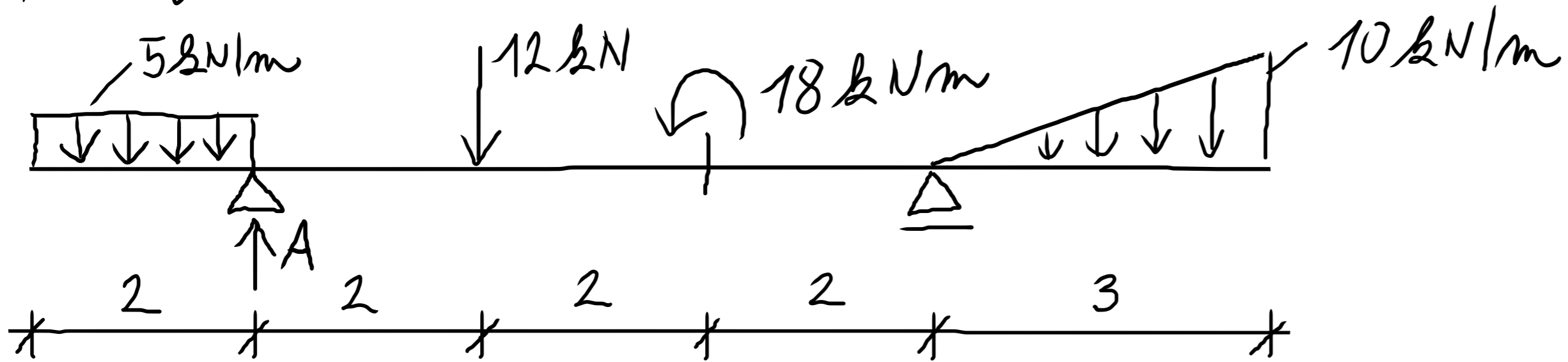

VYPOČÍTEJTE:
 - REAKCE
 - $V(l/2)$; $M(l/2)$

A

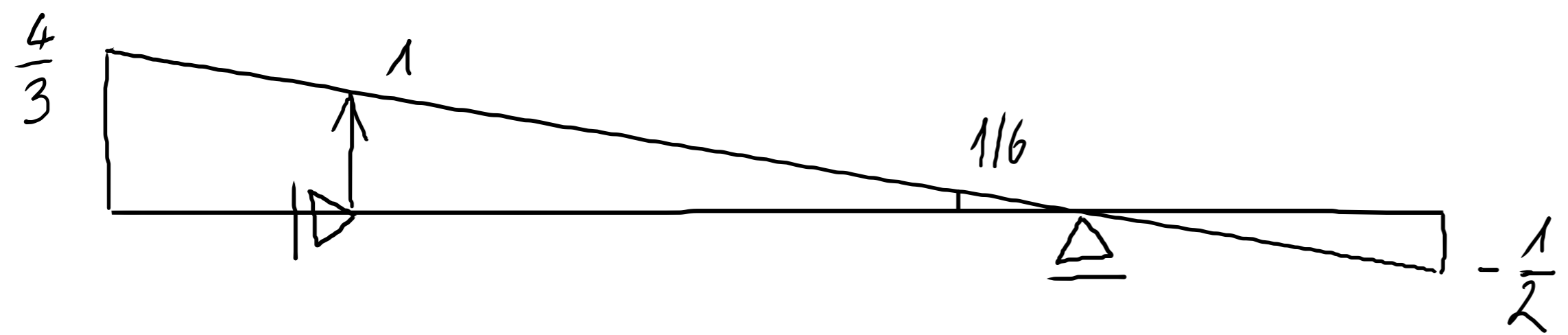

PŘÍČINKOVÉ ČÁRY - VÝPOČET VELIČIN

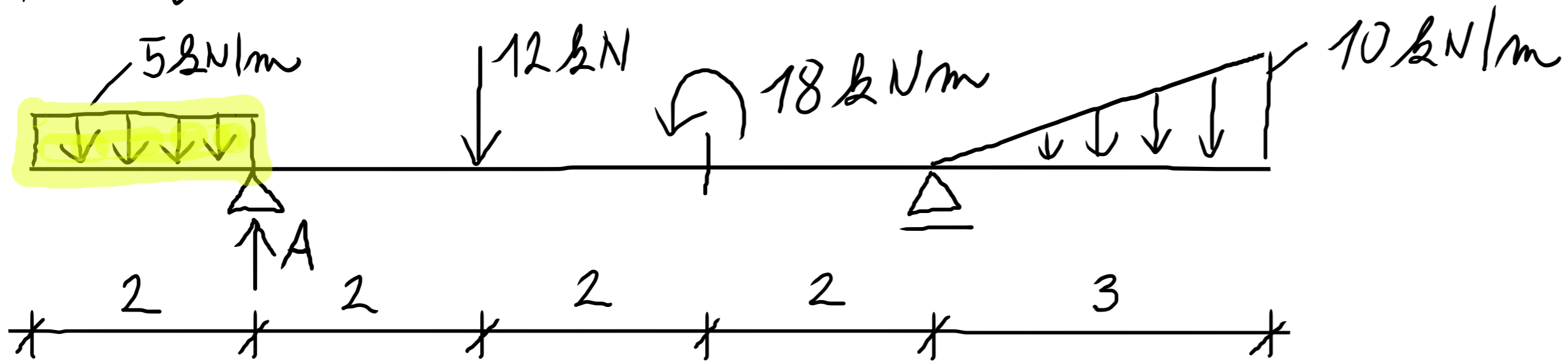

VYPOČÍTEJTE:
 - REAKCE
 - $V(x/2)$; $M(x/2)$

A

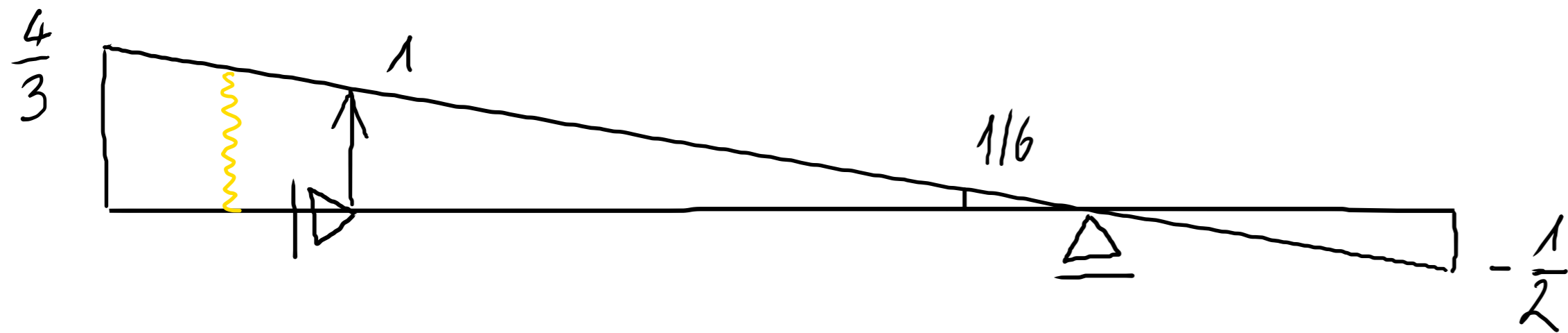

$$A = 5 \cdot 2 \cdot \frac{1}{2} \left(1 + \frac{4}{3} \right)$$

PŘÍČINKOVÉ ČÁRY - VÝPOČET VELIČIN

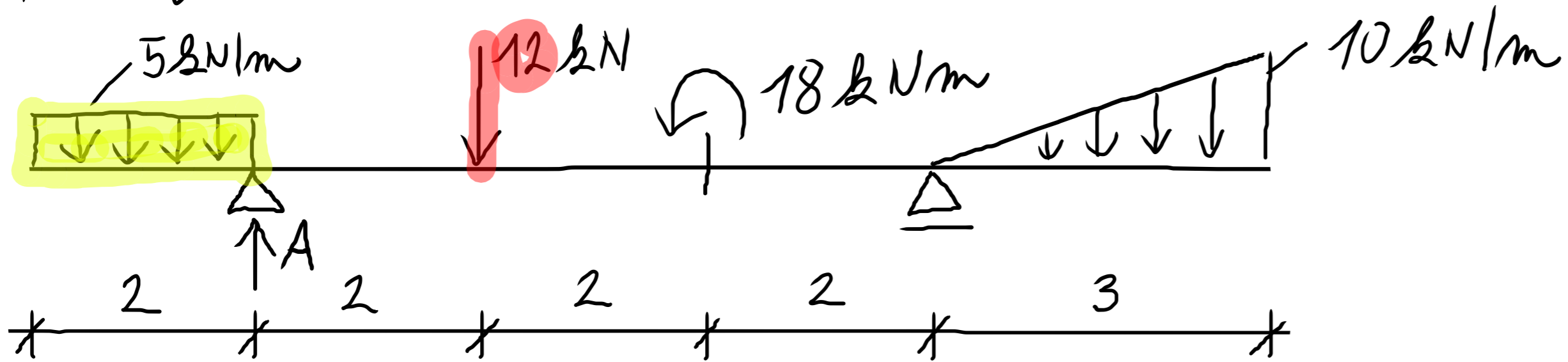

VYPOČÍTEJTE:
 - REAKCE
 - $V(x/2)$; $M(x/2)$

A

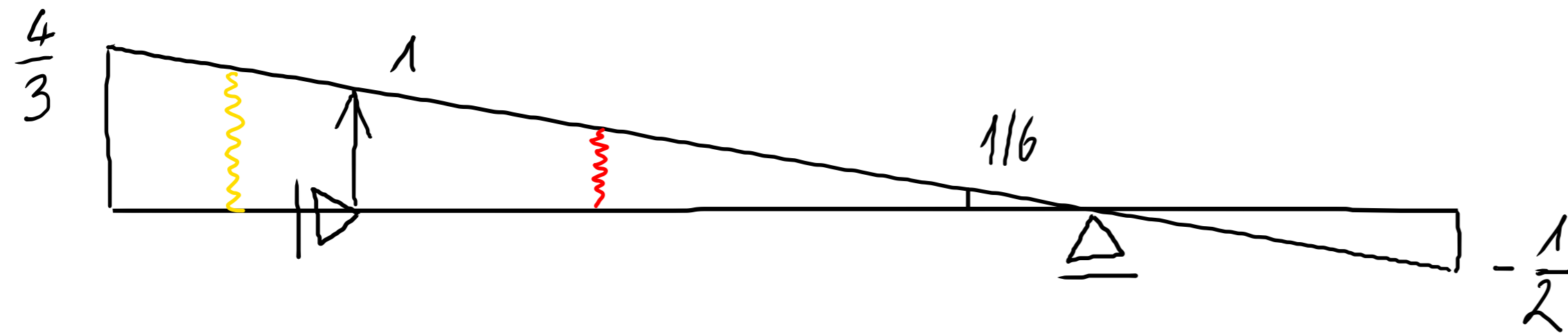

$$A = 5 \cdot 2 \cdot \frac{1}{2} \left(1 + \frac{4}{3} \right) + 12 \cdot \frac{2}{3}$$

PŘÍČINKOVÉ ČÁRY - VÝPOČET VELIČIN

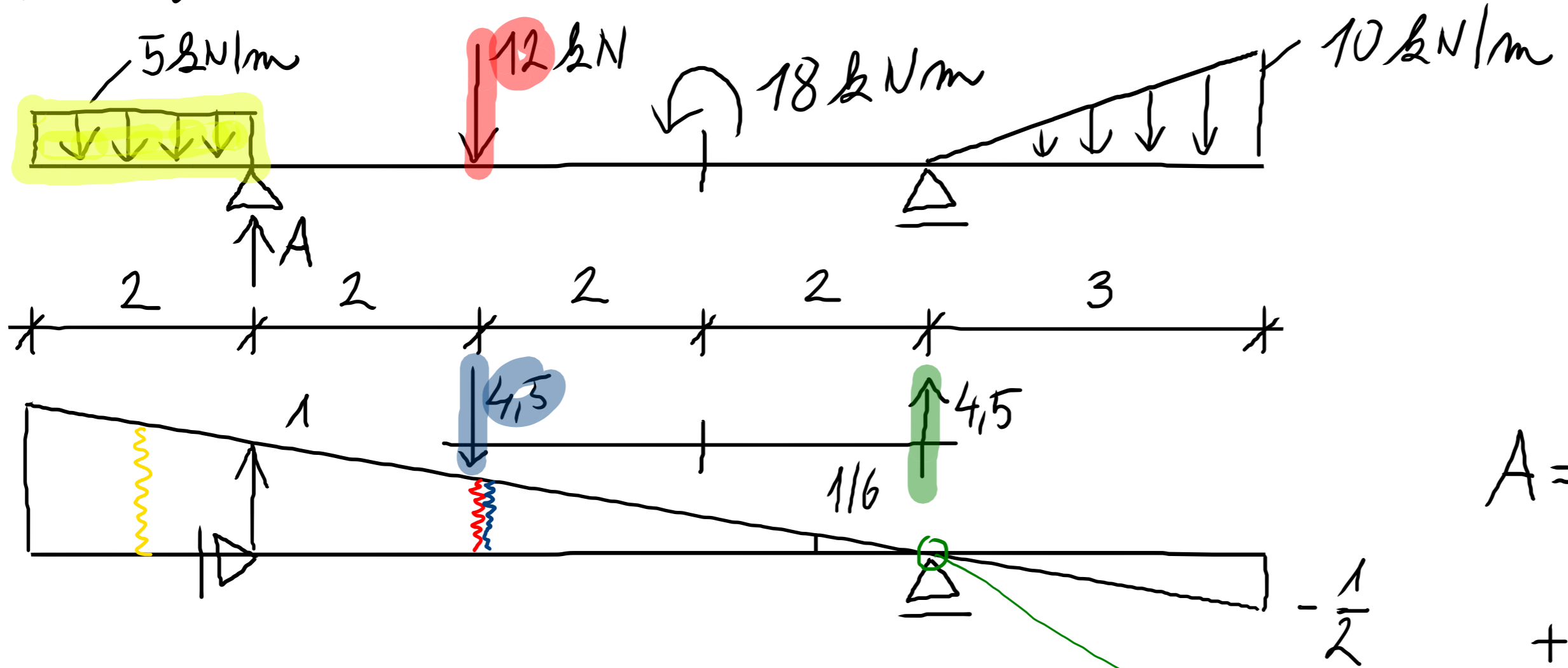

VYPOČÍTEJTE:
 - REAKCE
 - $V(x/2)$; $M(x/2)$

$$A = 5 \cdot 2 \cdot \frac{1}{2} \left(1 + \frac{4}{3}\right) + 12 \cdot \frac{2}{3} + 4,5 \cdot \frac{2}{3} - 4,5 \cdot 0$$

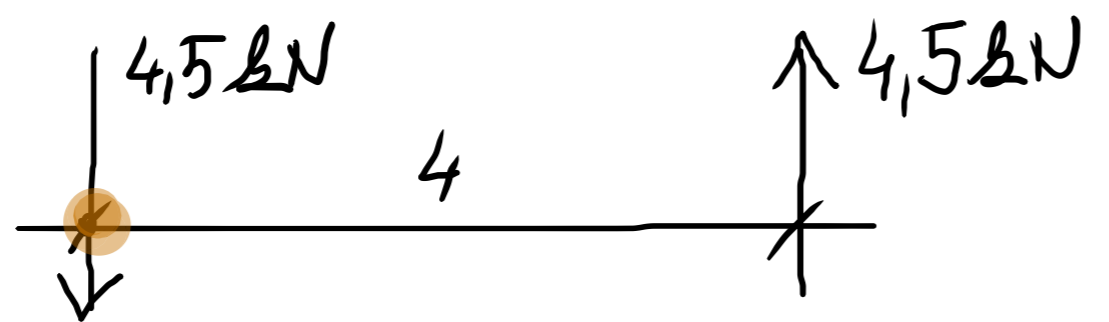

$$M = 4,5 \cdot 4 = 18 \text{ kNm}$$

A

PŘÍČINKOVÉ ČÁRY - VÝPOČET VELIČIN

A

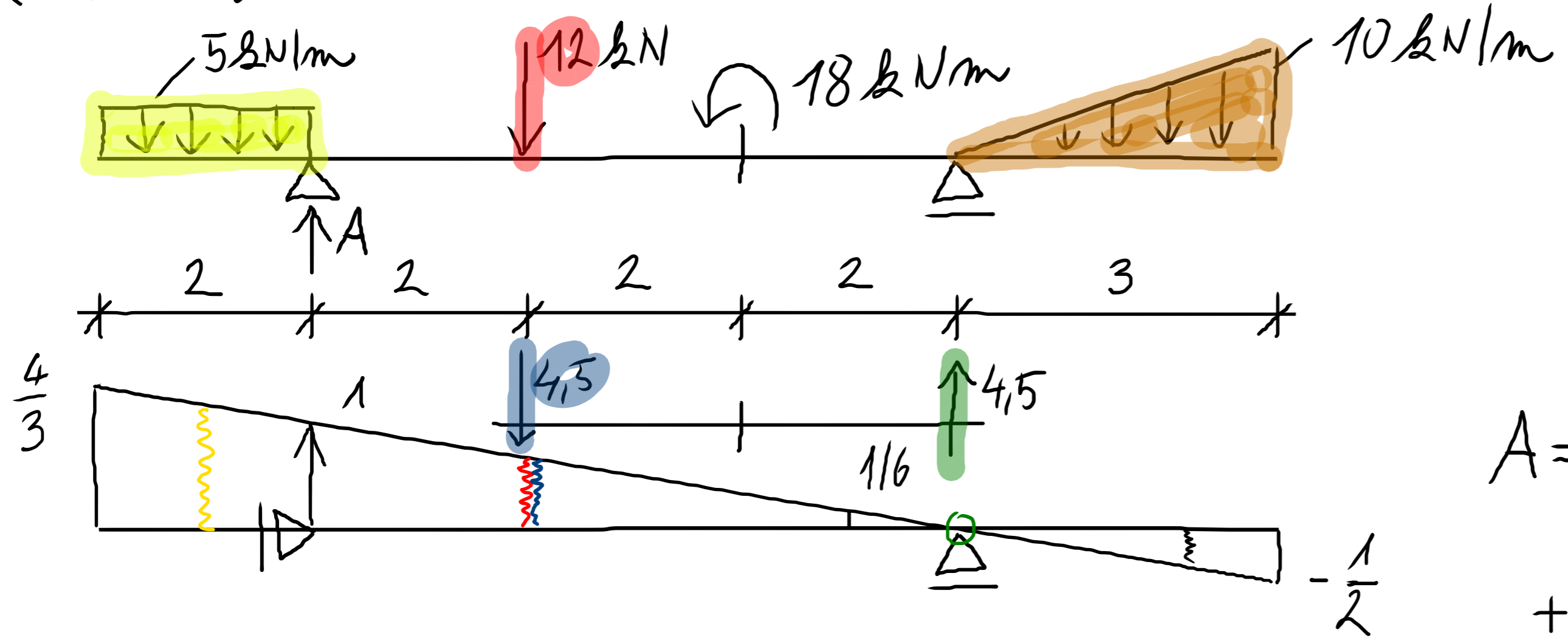

VYPOČÍTEJTE:
 - REAKCE
 - $V(x/2)$; $M(x/2)$

$$\begin{aligned}
 A = & \underbrace{5 \cdot 2 \cdot \frac{1}{2}}_{\text{yellow}} \underbrace{\left(1 + \frac{4}{3}\right)}_{\text{yellow}} + \underbrace{12 \cdot \frac{2}{3}}_{\text{red}} + \\
 & \underbrace{+ 4.5 \cdot \frac{2}{3}}_{\text{blue}} - \underbrace{4.5 \cdot 0}_{\text{green}} + \\
 & \underbrace{+ \frac{1}{2} \cdot 10 \cdot 3 \cdot \frac{2}{3}}_{\text{brown}} \cdot \underbrace{\left(-\frac{1}{2}\right)}_{\text{brown}} =
 \end{aligned}$$

PŘÍČINKOVÉ ČÁRY - VÝPOČET VELIČIN

A

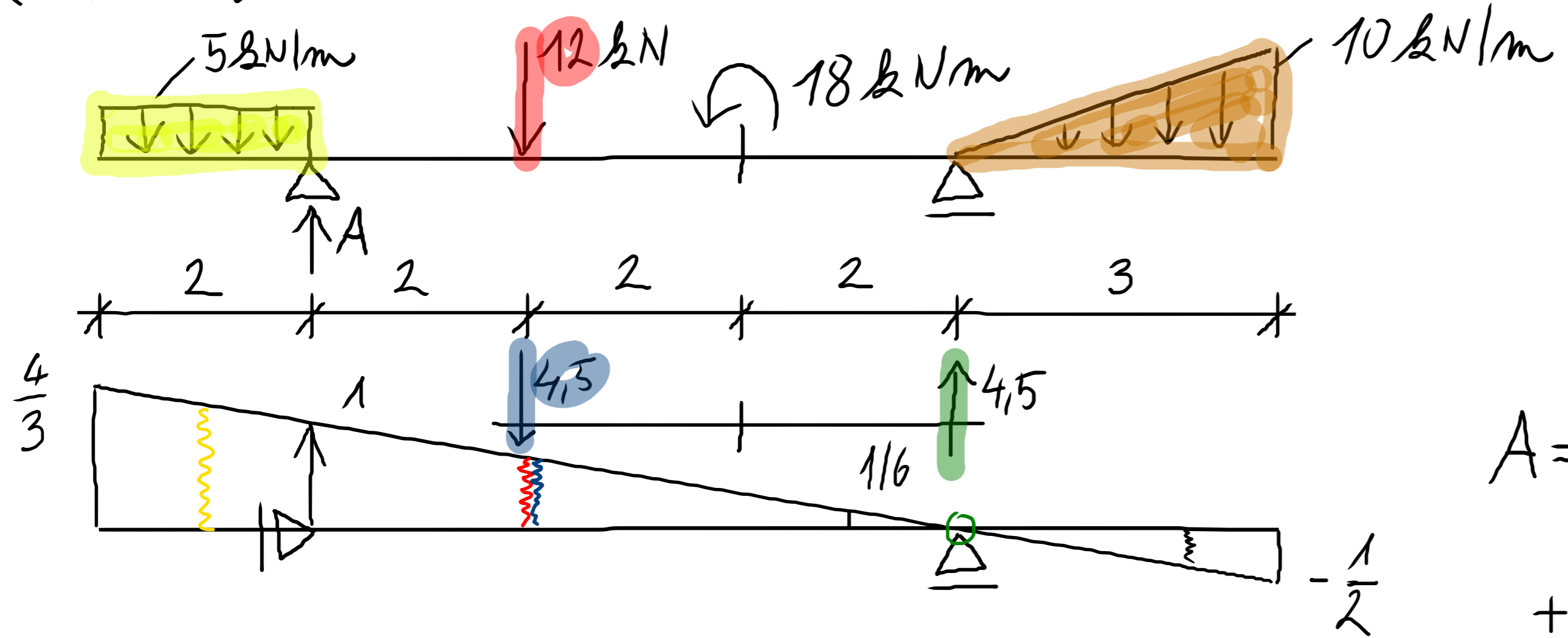

VYPOČÍTEJTE:
 - REAKCE
 - $V(x/2)$; $M(x/2)$

$$\begin{aligned}
 A = & \underbrace{5 \cdot 2 \cdot \frac{1}{2} \left(1 + \frac{4}{3}\right)}_{\text{yellow}} + \underbrace{12 \cdot \frac{2}{3}}_{\text{red}} + \\
 & \underbrace{+ 4,5 \cdot \frac{2}{3}}_{\text{blue}} - \underbrace{4,5 \cdot 0}_{\text{green}} + \\
 & \underbrace{+ \frac{1}{2} \cdot 10 \cdot 3 \cdot \frac{2}{3} \cdot \left(-\frac{1}{2}\right)}_{\text{orange}} = 17,6 \text{ kN}
 \end{aligned}$$

PŘÍČINKOVÉ ČÁRY - VÝPOČET VELIČIN

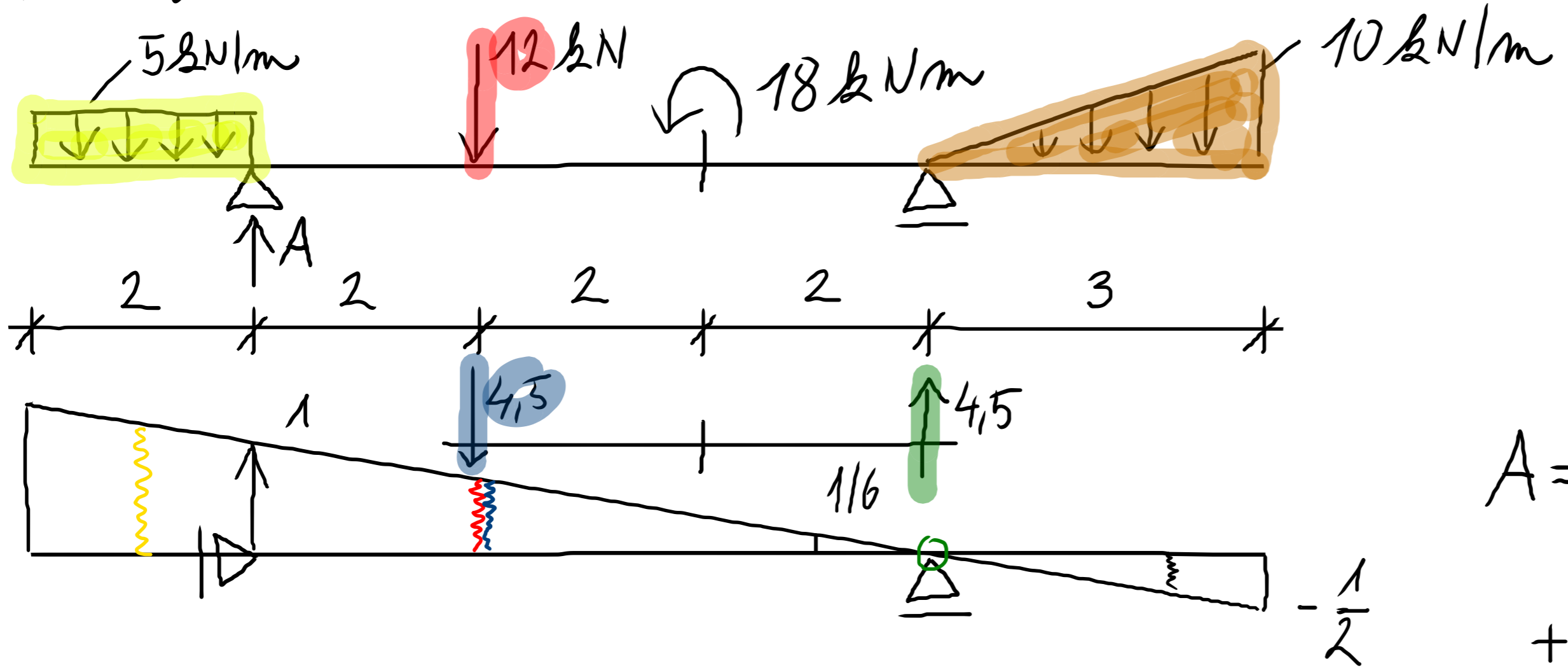

VYPOČÍTEJTE:
 - REAKCE
 - $V(x/2)$; $M(x/2)$

A

$$\begin{aligned}
 A = & \underbrace{5 \cdot 2 \cdot \frac{1}{2} \left(1 + \frac{4}{3}\right)}_{\text{yellow}} + \underbrace{12 \cdot \frac{2}{3}}_{\text{red}} + \\
 & \underbrace{+ 4,5 \cdot \frac{2}{3}}_{\text{blue}} - \underbrace{4,5 \cdot 0}_{\text{green}} + \\
 & \underbrace{+ \frac{1}{2} \cdot 10 \cdot 3 \cdot \frac{2}{3} \cdot \left(-\frac{1}{2}\right)}_{\text{orange}} = 17,6 \text{ kN}
 \end{aligned}$$

B

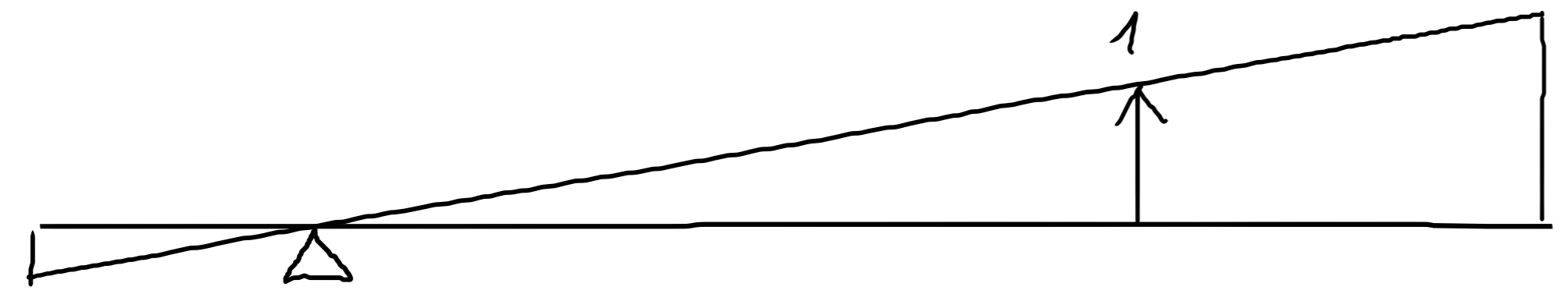

PŘÍČINKOVÉ ČÁRY - VÝPOČET VELIČIN

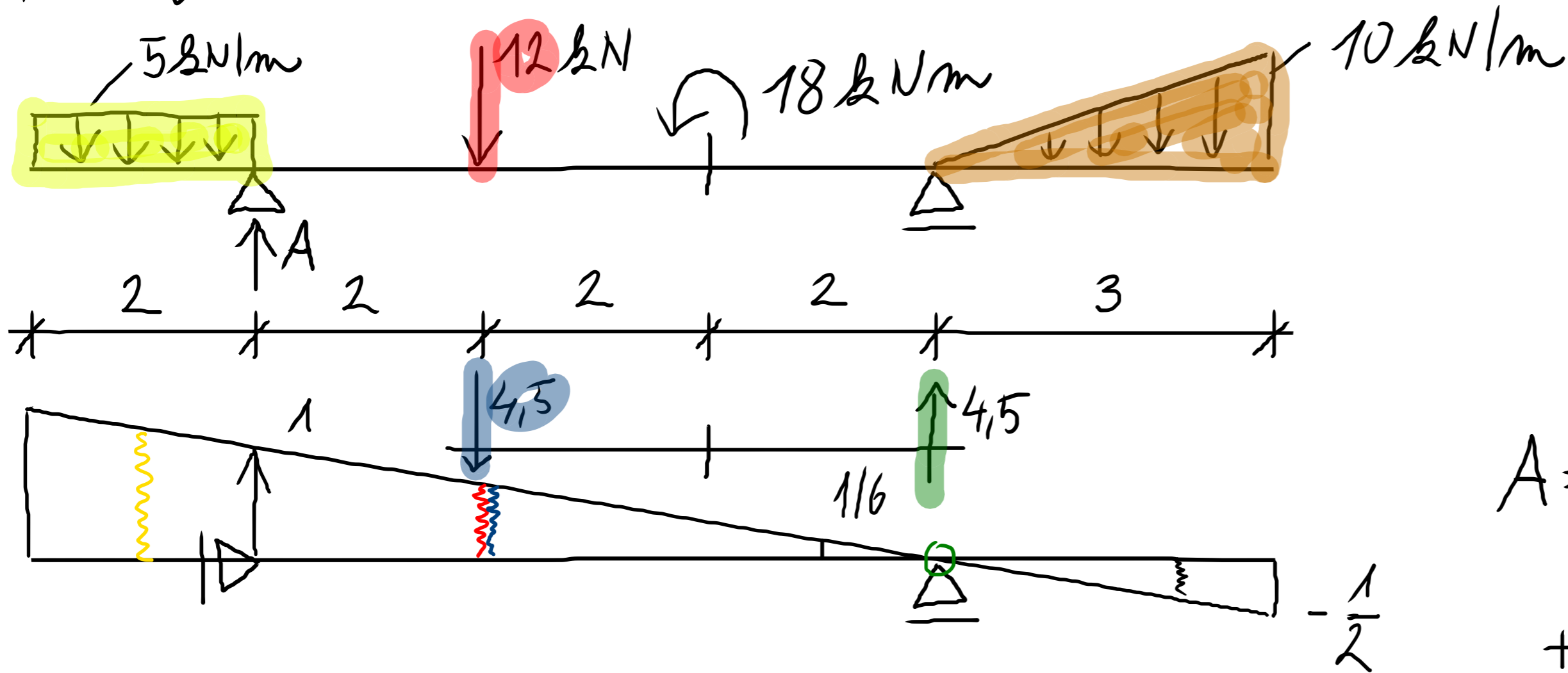

A

B

VYPOČÍTEJTE:

- REAKCE
- $V(l/2)$; $M(l/2)$

$$\begin{aligned}
 A = & \underbrace{5 \cdot 2 \cdot \frac{1}{2} \left(1 + \frac{4}{3}\right)}_{\text{yellow}} + \underbrace{12 \cdot \frac{2}{3}}_{\text{red}} + \\
 & \underbrace{+ 4,5 \cdot \frac{2}{3}}_{\text{blue}} - \underbrace{4,5 \cdot 0}_{\text{green}} + \\
 & \underbrace{+ \frac{1}{2} \cdot 10 \cdot 3 \cdot \frac{2}{3} \cdot \left(-\frac{1}{2}\right)}_{\text{orange}} = 17,6 \text{ kN}
 \end{aligned}$$

$$B = \dots = 19,3 \text{ kN}$$

PŘÍČINKOVÉ ČÁRY - VÝPOČET VELIČIN

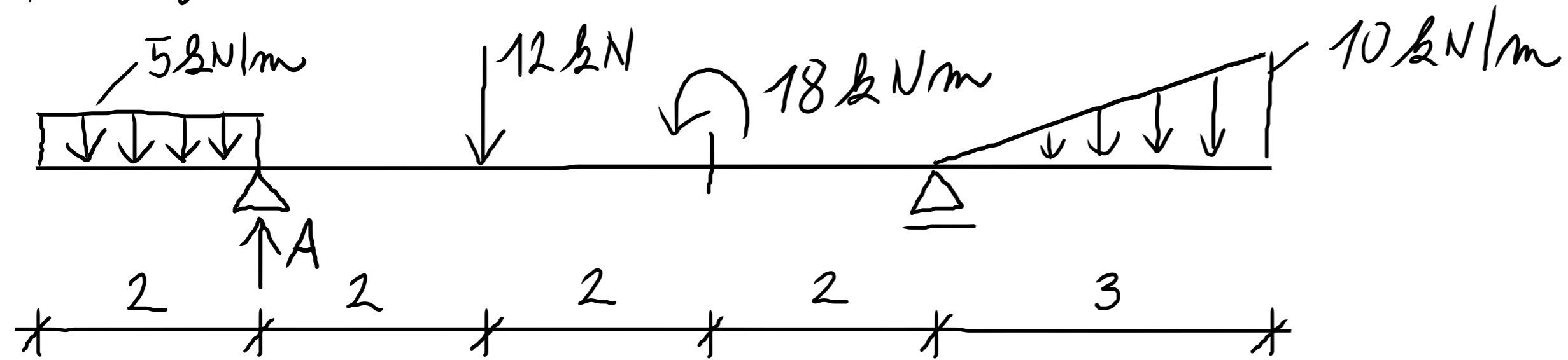

VYPOČÍTEJTE:
 - REAKCE
 - $V(x/2)$; $M(x/2)$

$V_{x/2}$

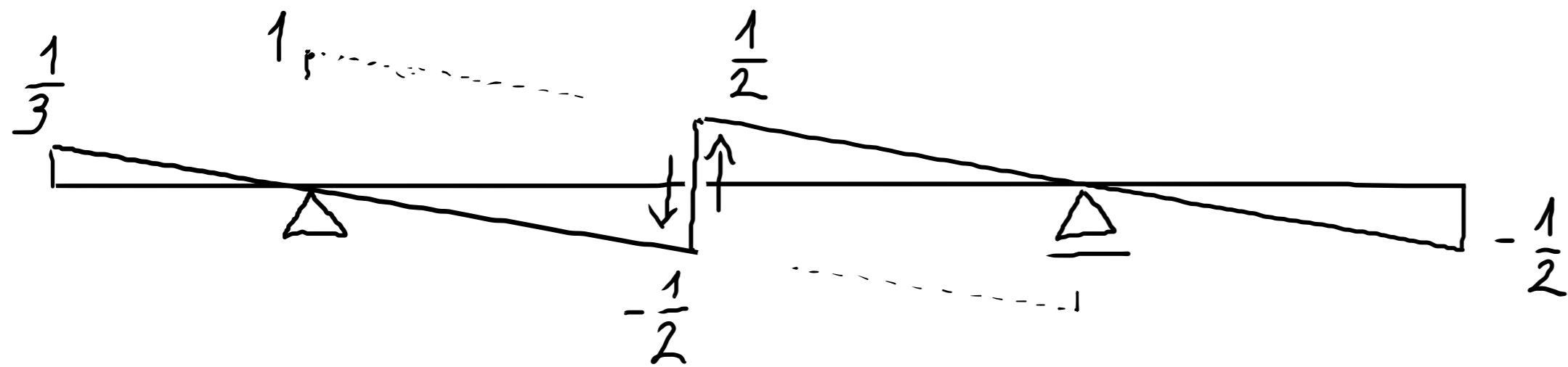

$M_{x/2}$

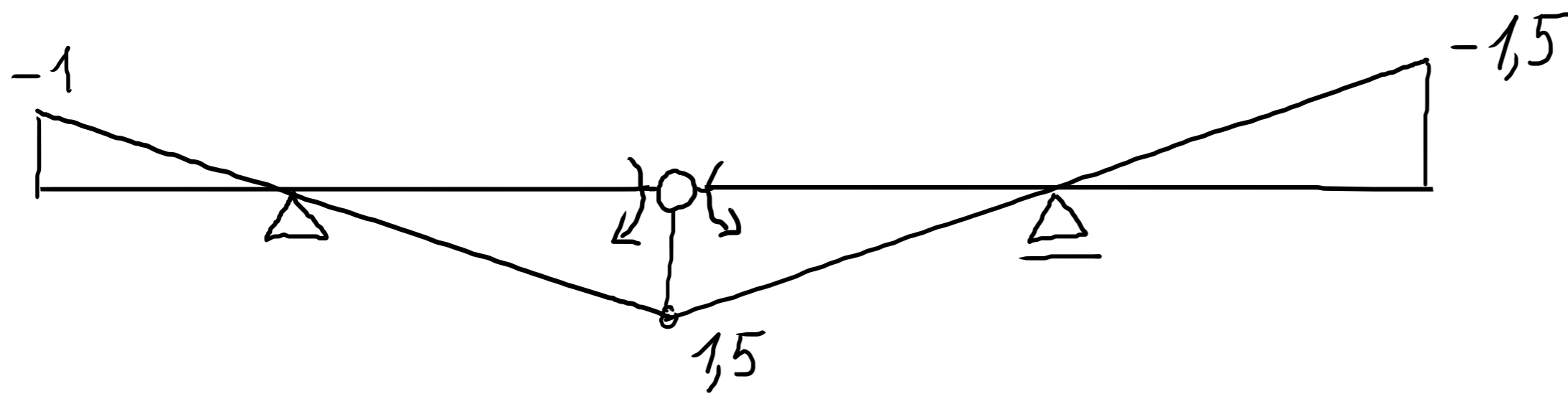

PŘÍČINKOVÉ ČÁRY - VÝPOČET VELIČIN

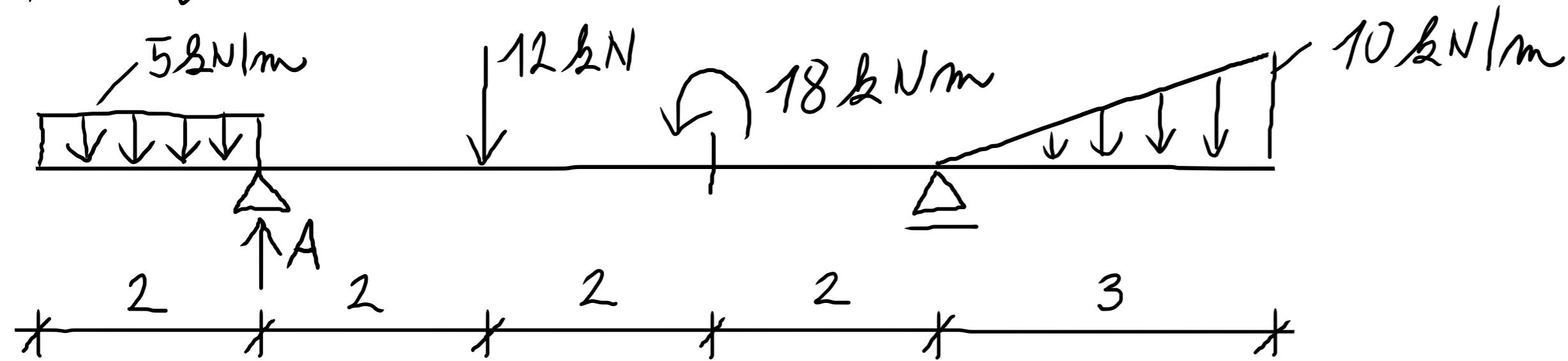

$V_{l/2}$

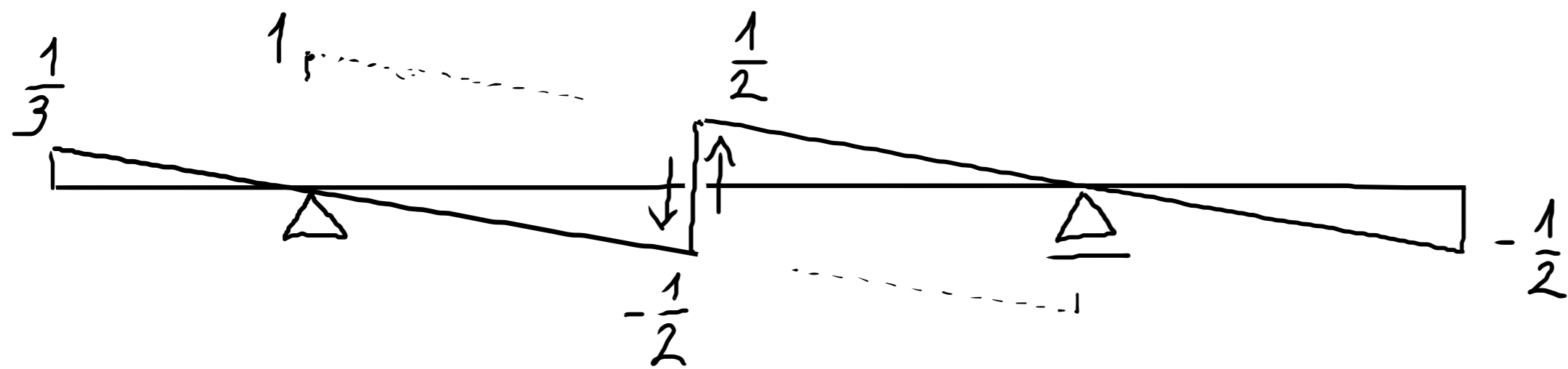

$M_{l/2}$

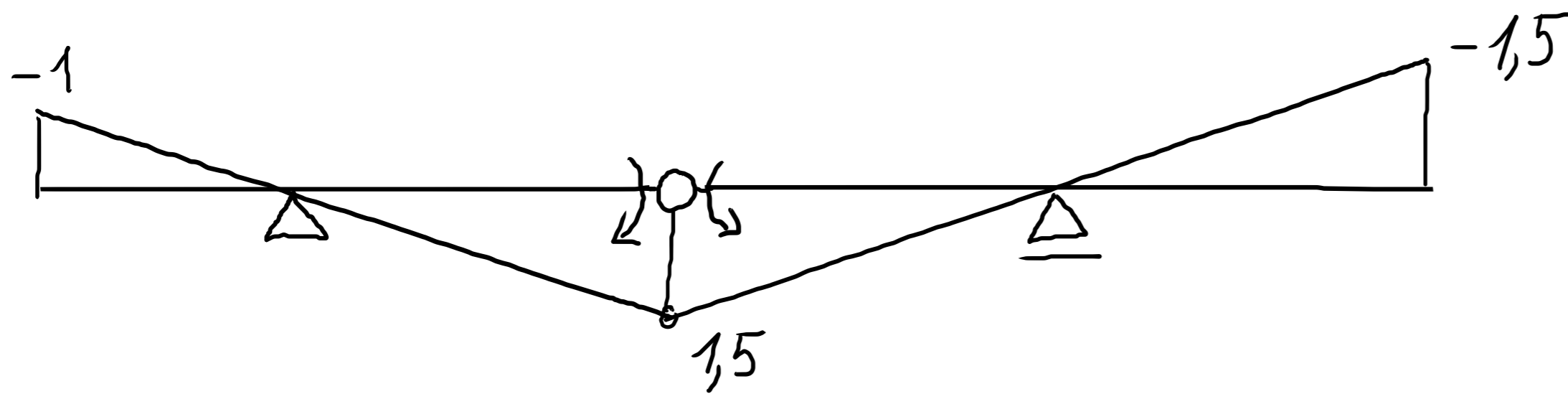

VYPOČÍTEJTE:

- REAKCE
- $V(l/2)$; $M(l/2)$

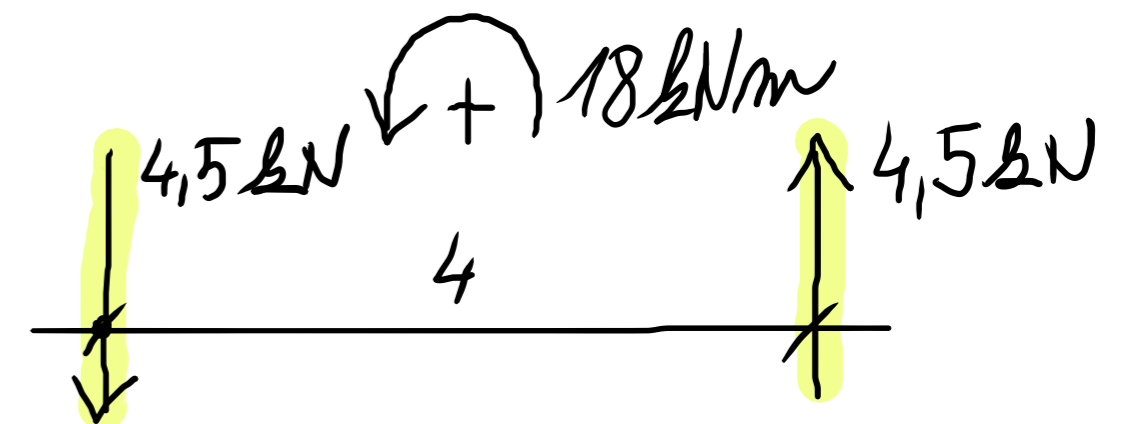

$$M = 4,5 \cdot 4 = 18 \text{ kNm}$$

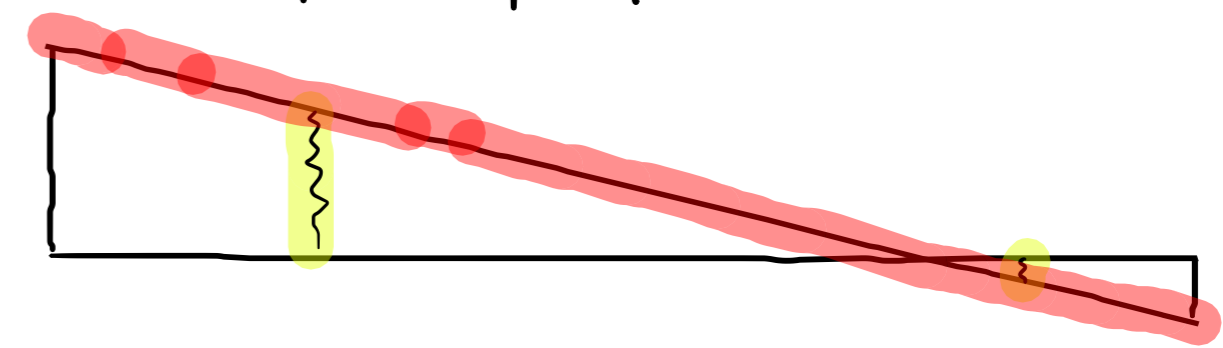

PŘÍČINKOVÉ ČÁRY - VÝPOČET VELIČIN

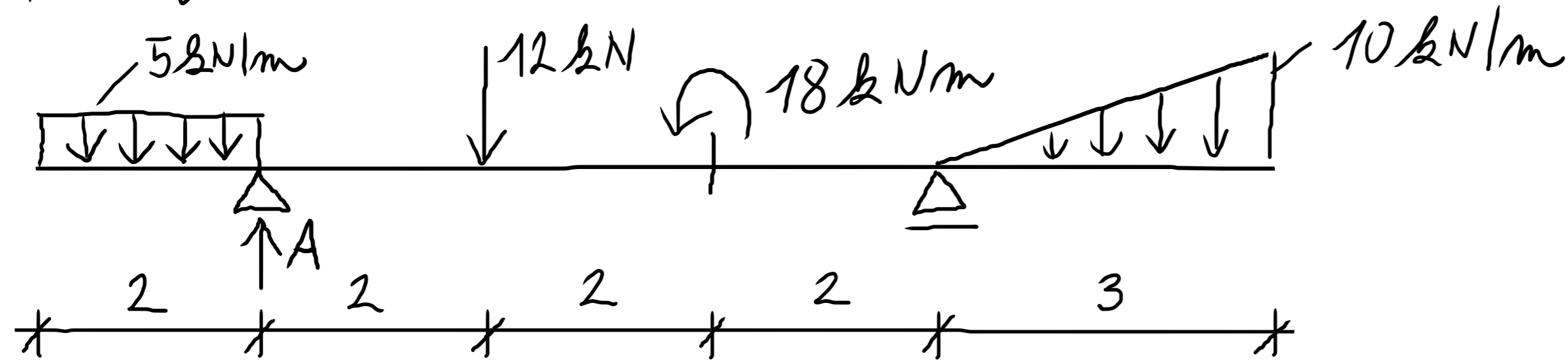

$V_{l/2}$

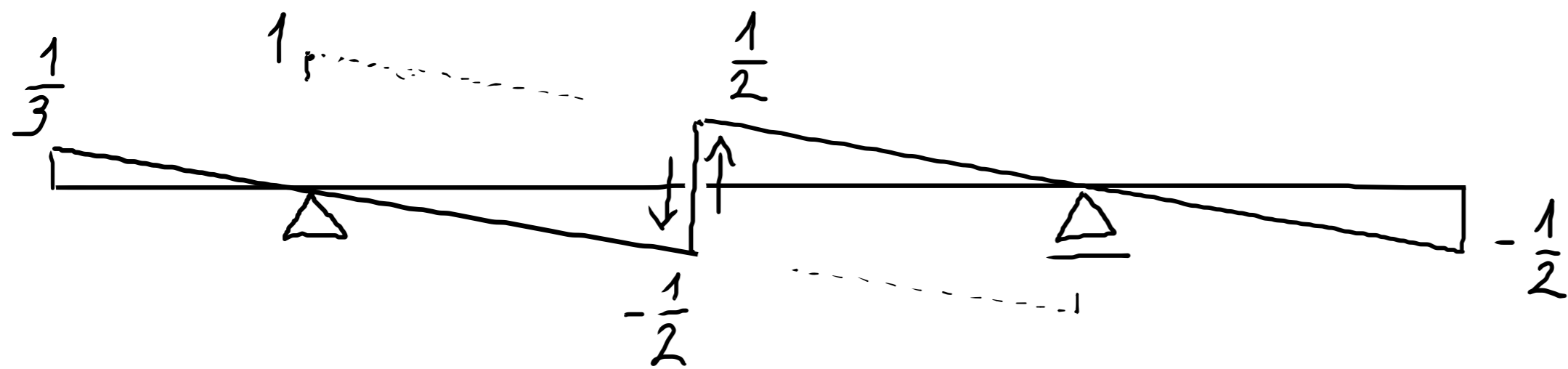

$M_{l/2}$

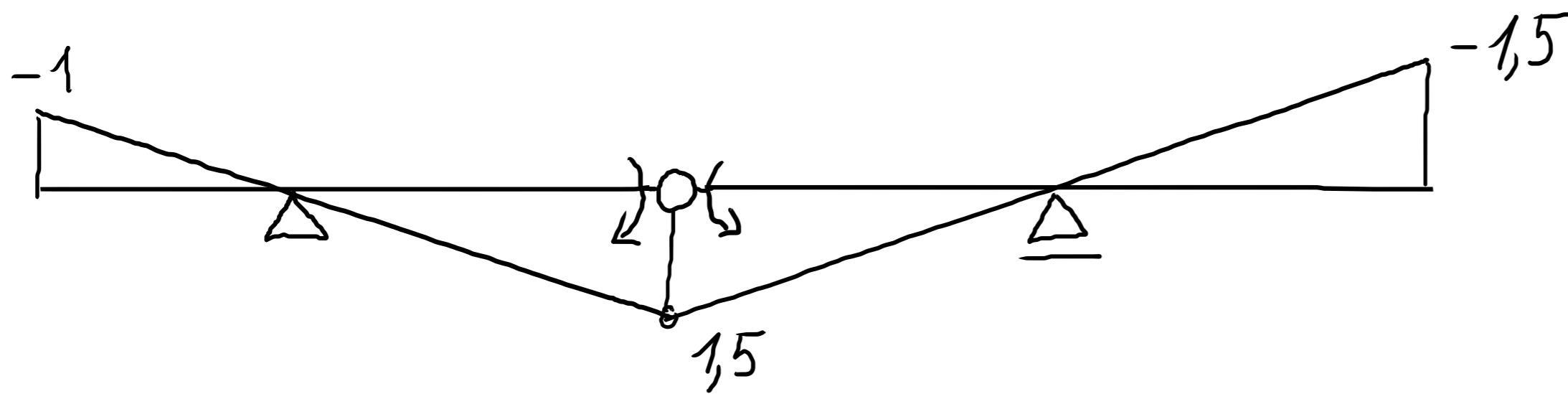

VYPOČÍTEJTE:

- REAKCE
- $V(l/2)$; $M(l/2)$

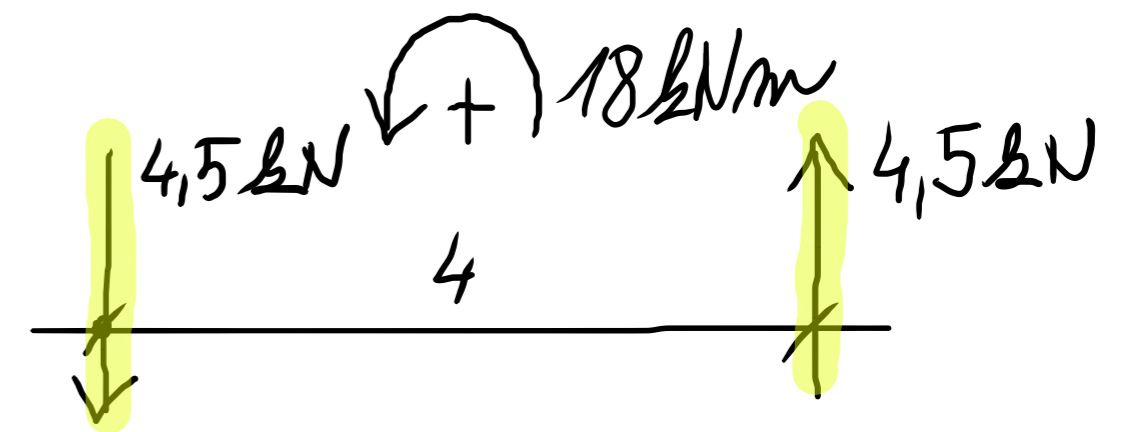

$$M = 4,5 \cdot 4 = 18 \text{ kNm}$$

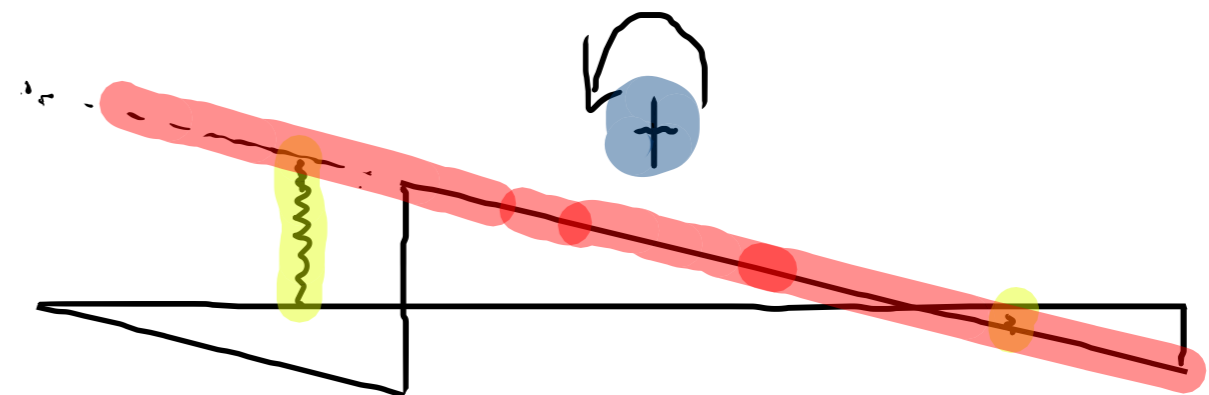
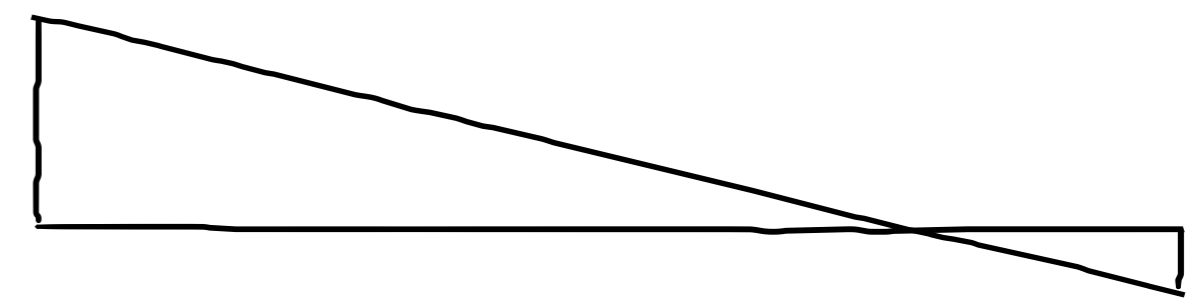

PŘÍČINKOVÉ ČÁRY - VÝPOČET VELIČIN

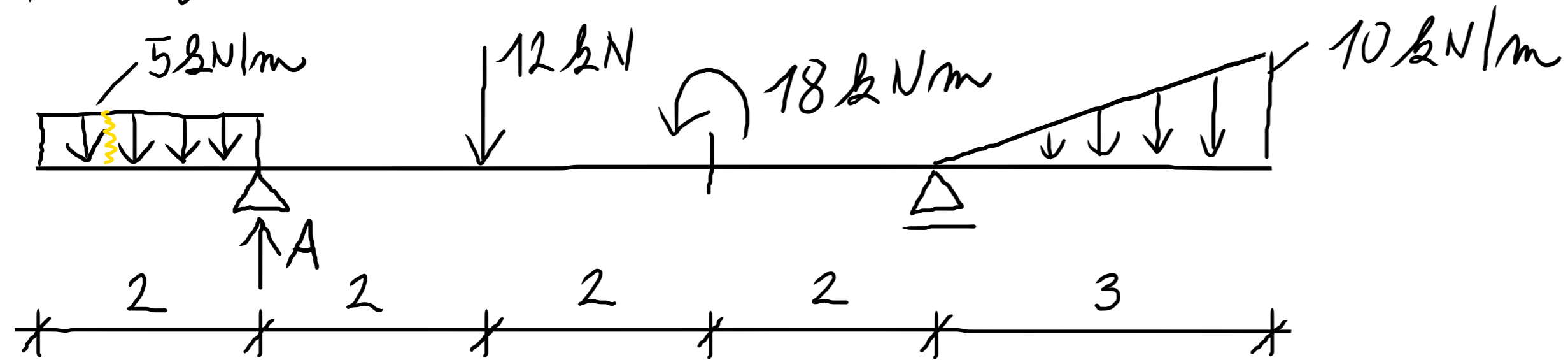

VYPOČÍTEJTE:
 - REAKCE
 - $V(x/2)$; $M(x/2)$

$$V_{x/2} = \frac{1}{2} \cdot \frac{1}{3} \cdot 2 \cdot 5$$

$V_{x/2}$

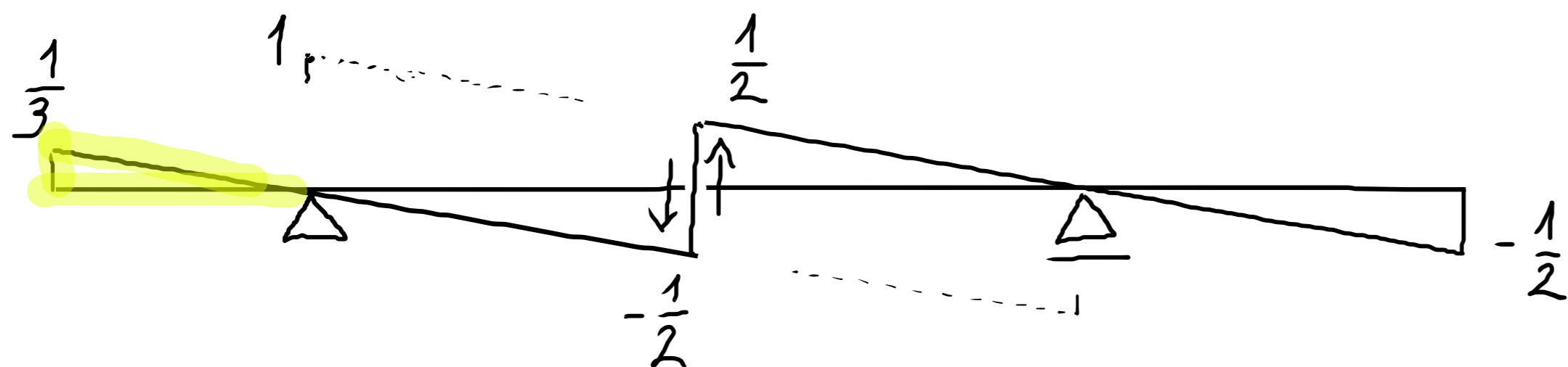

$M_{x/2}$

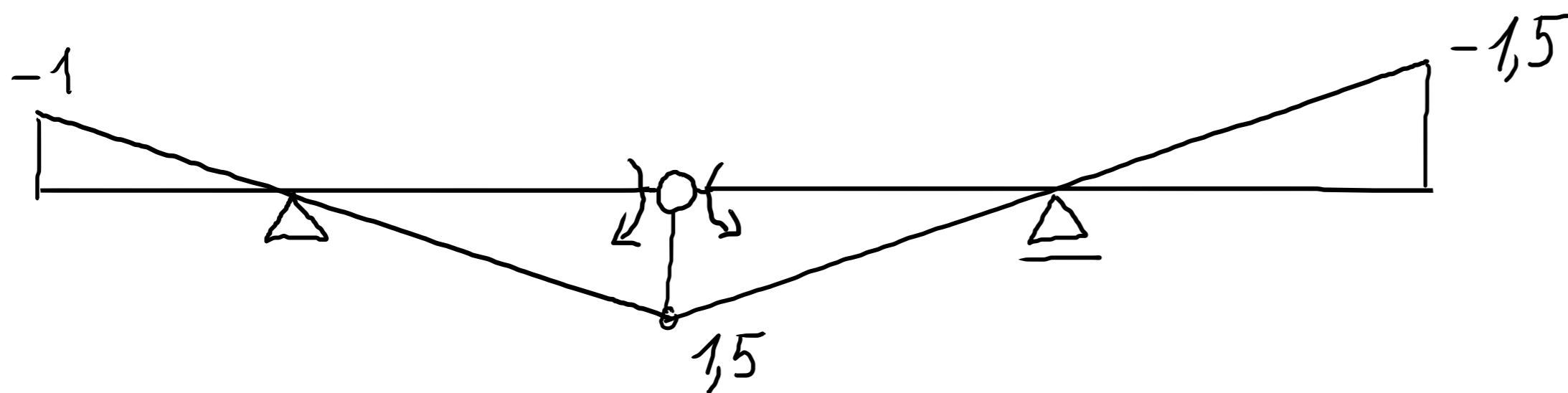

PŘÍČINKOVÉ ČÁRY - VÝPOČET VELIČIN

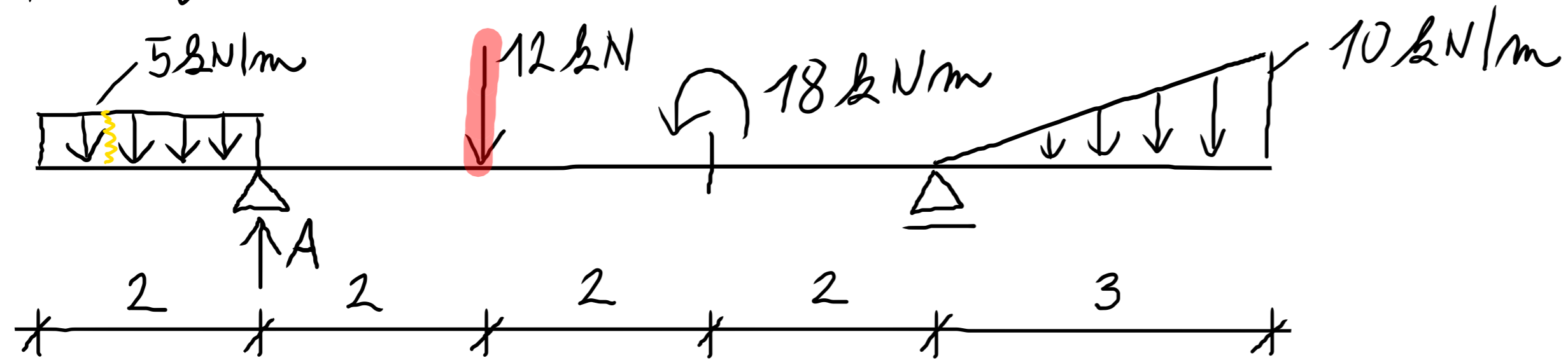

VYPOČÍTEJTE:

- REAKCE
- $V(x/2)$; $M(x/2)$

$$V_{x/2} = \frac{1}{2} \cdot \frac{1}{3} \cdot 2 \cdot 5 + 12 \cdot \frac{2}{3} \left(-\frac{1}{2}\right)$$

$V_{x/2}$

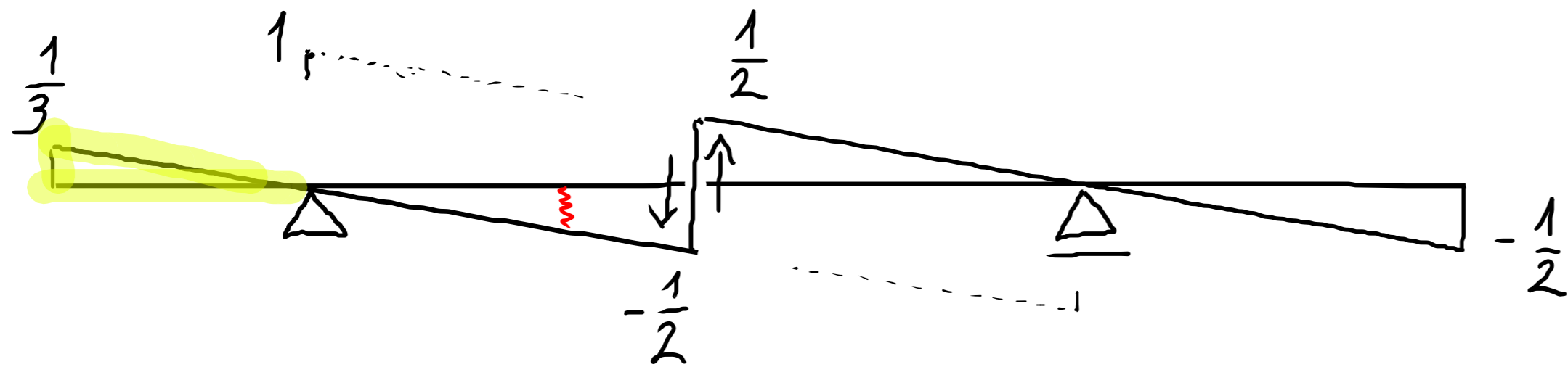

$M_{x/2}$

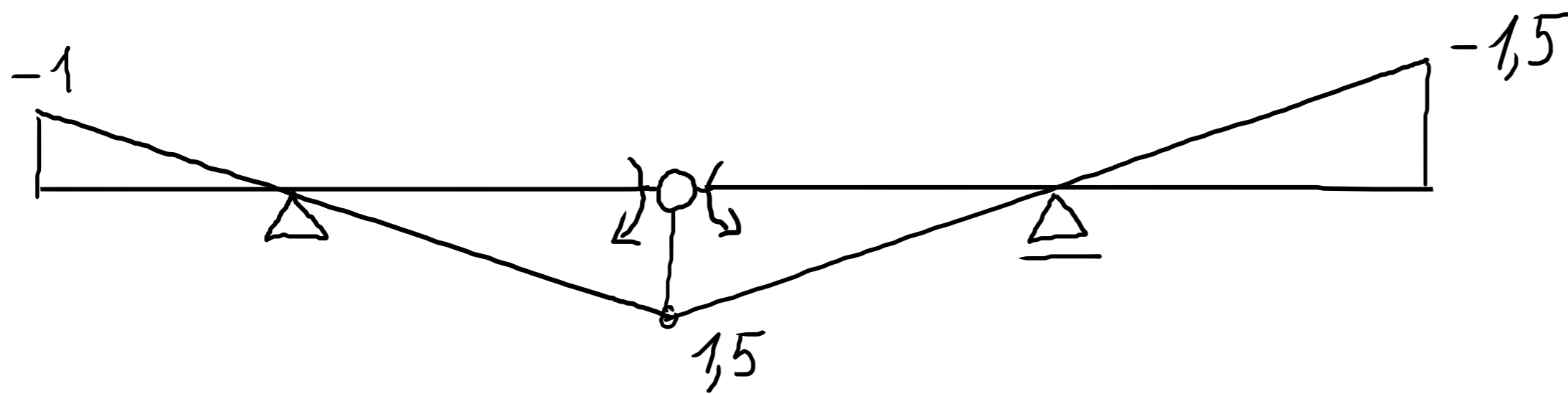

PŘÍČINKOVÉ ČÁRY - VÝPOČET VELIČIN

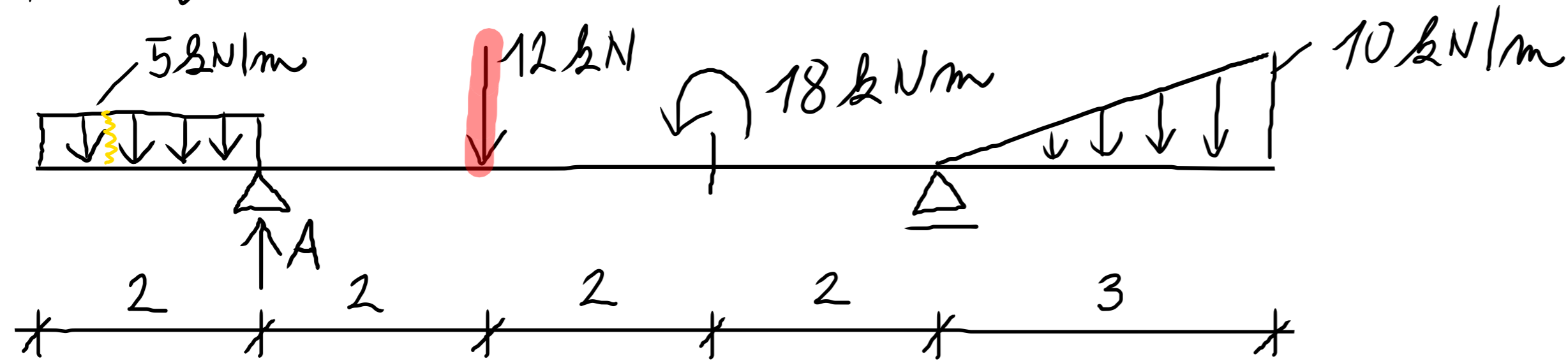

VYPOČÍTEJTE:

- REAKCE

- $V(x/2)$; $M(x/2)$

$$V_{x/2} = \frac{1}{2} \cdot \frac{1}{3} \cdot 2 \cdot 5 + 12 \cdot \frac{2}{3} \left(-\frac{1}{2}\right) + 4,5 \cdot \frac{4}{3} \cdot \frac{1}{2} - 4,5 \cdot 0$$

$V_{x/2}$

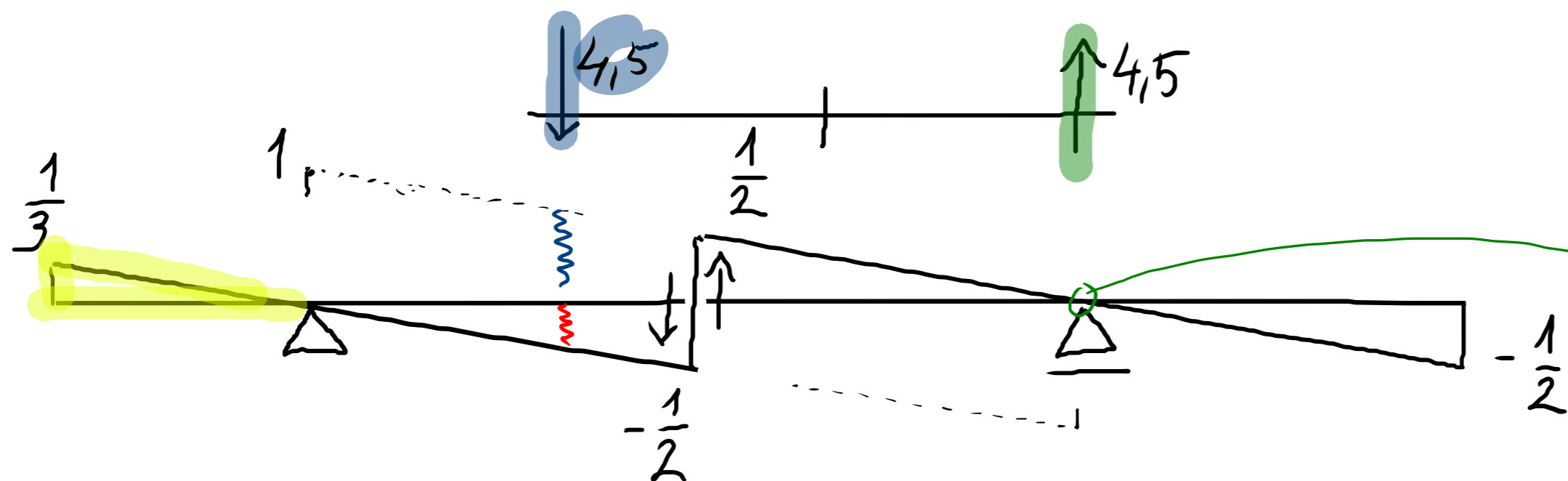

$M_{x/2}$

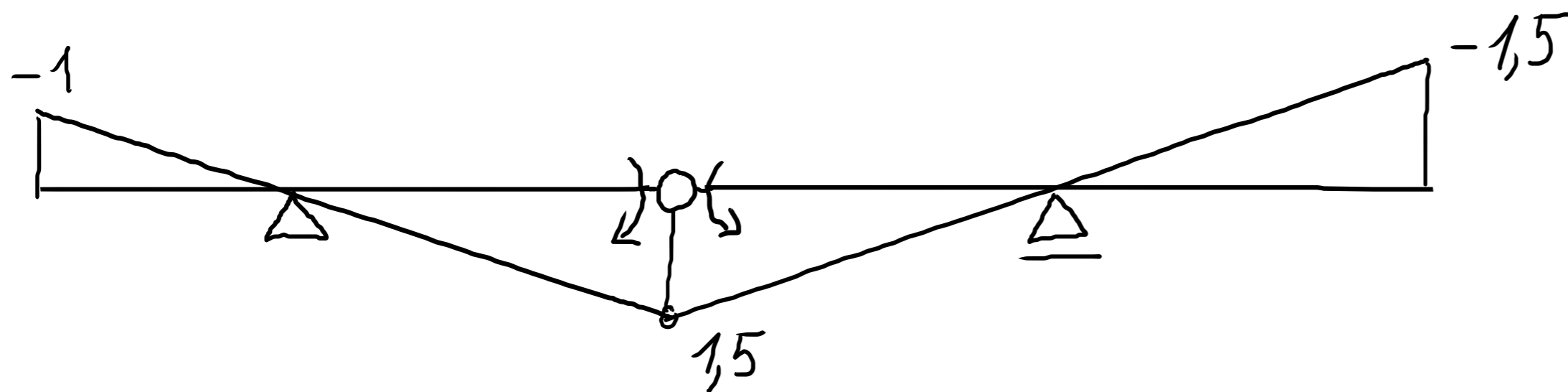

PŘÍČINKOVÉ ČÁRY - VÝPOČET VELIČIN

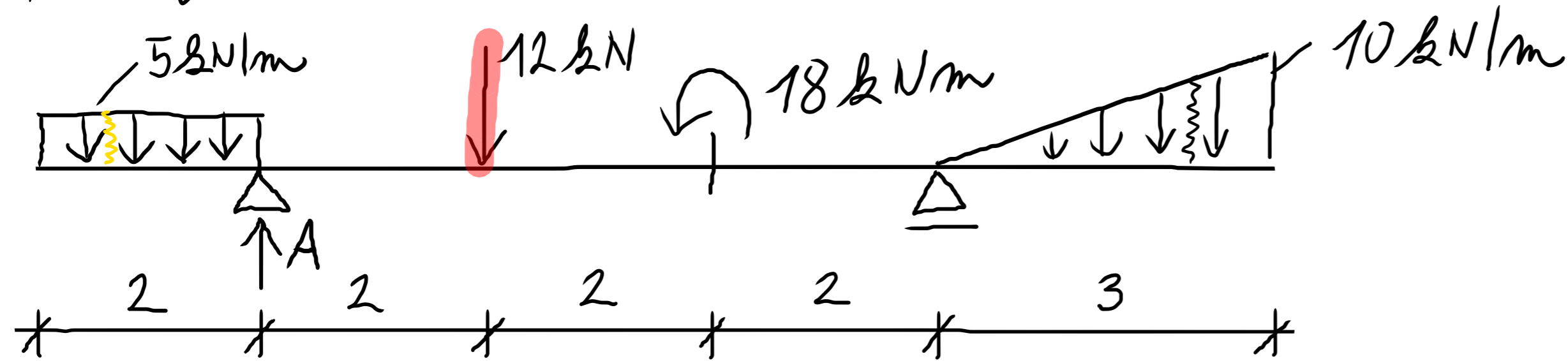

VYPOČÍTEJTE:

- REAKCE

- $V(x/2)$; $M(x/2)$

$V_{x/2}$

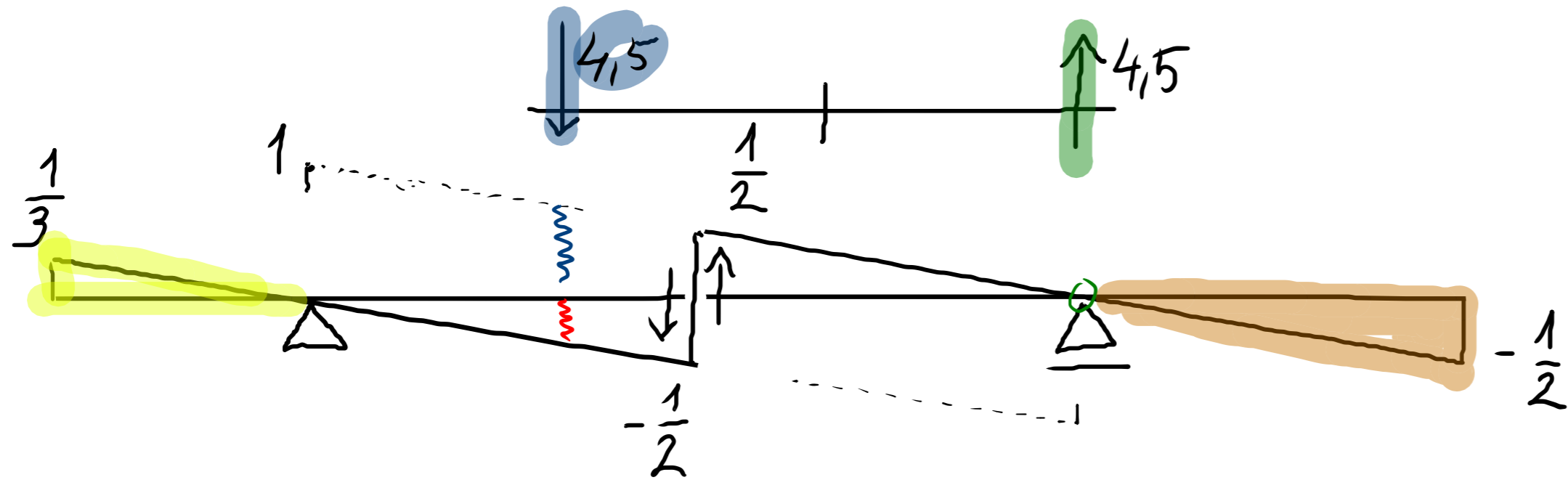

$$\begin{aligned}
 V_{x/2} &= \frac{1}{2} \cdot \frac{1}{3} \cdot 2 \cdot 5 + 12 \cdot \frac{2}{3} \left(-\frac{1}{2}\right) + \\
 &+ 4,5 \cdot \frac{4}{3} \cdot \frac{1}{2} - 4,5 \cdot 0 + \frac{1}{2} \cdot \left(-\frac{1}{2}\right) \cdot 3 \cdot \frac{2}{3} \cdot 10 = \\
 &=
 \end{aligned}$$

$M_{x/2}$

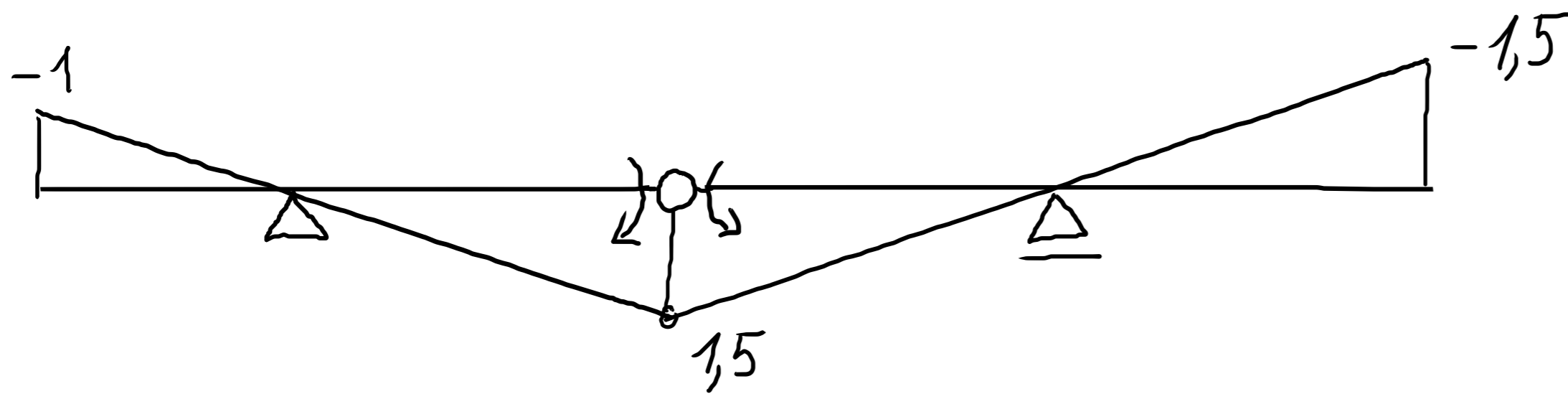

PŘÍČINKOVÉ ČÁRY - VÝPOČET VELIČIN

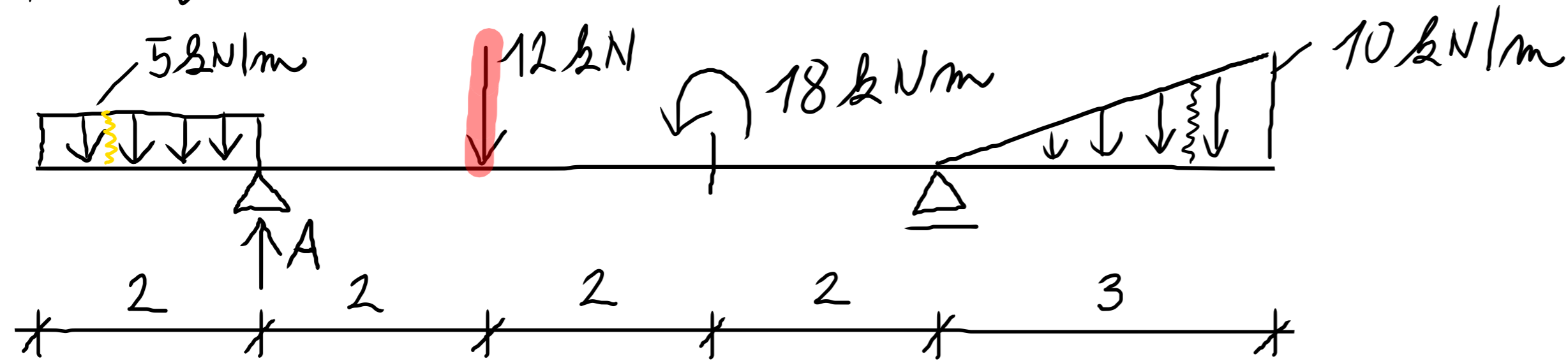

VYPOČÍTEJTE:

- REAKCE
- $V(x/2)$; $M(x/2)$

$V_{x/2}$

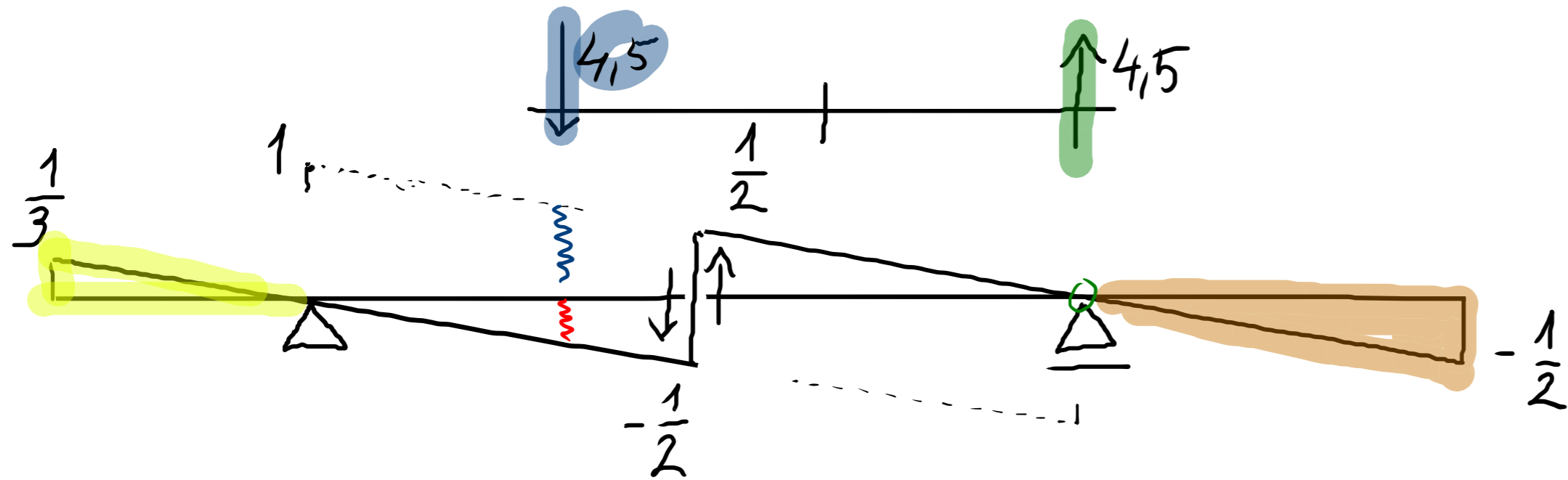

$$\begin{aligned}
 V_{x/2} &= \frac{1}{2} \cdot \frac{1}{3} \cdot 2 \cdot 5 + 12 \cdot \frac{2}{3} \left(-\frac{1}{2}\right) + \\
 &+ 4,5 \cdot \frac{4}{3} \cdot \frac{1}{2} - 4,5 \cdot 0 + \frac{1}{2} \cdot \left(-\frac{1}{2}\right) \cdot 3 \cdot \frac{2}{3} \cdot 10 = \\
 &= -4,3 \text{ kN}
 \end{aligned}$$

$M_{x/2}$

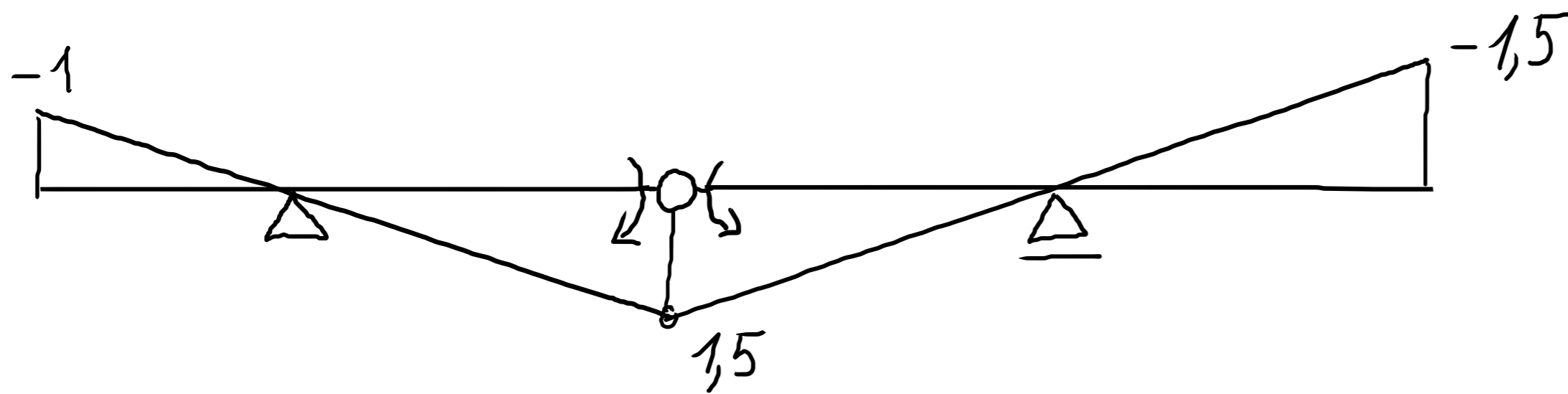

PŘÍČINKOVÉ ČÁRY - VÝPOČET VELIČIN

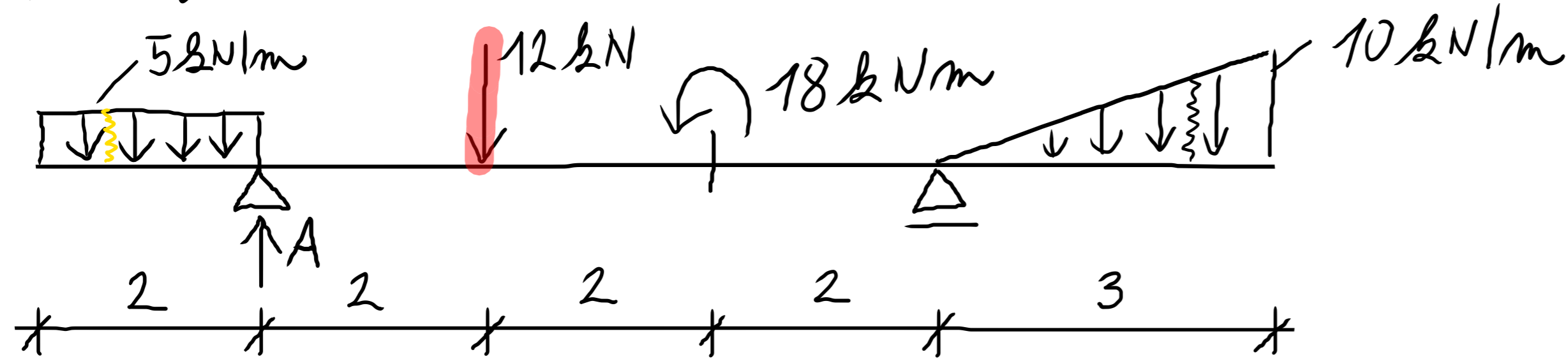

VYPOČÍTEJTE:

- REAKCE
- $V(x/2)$; $M(x/2)$

$V_{x/2}$

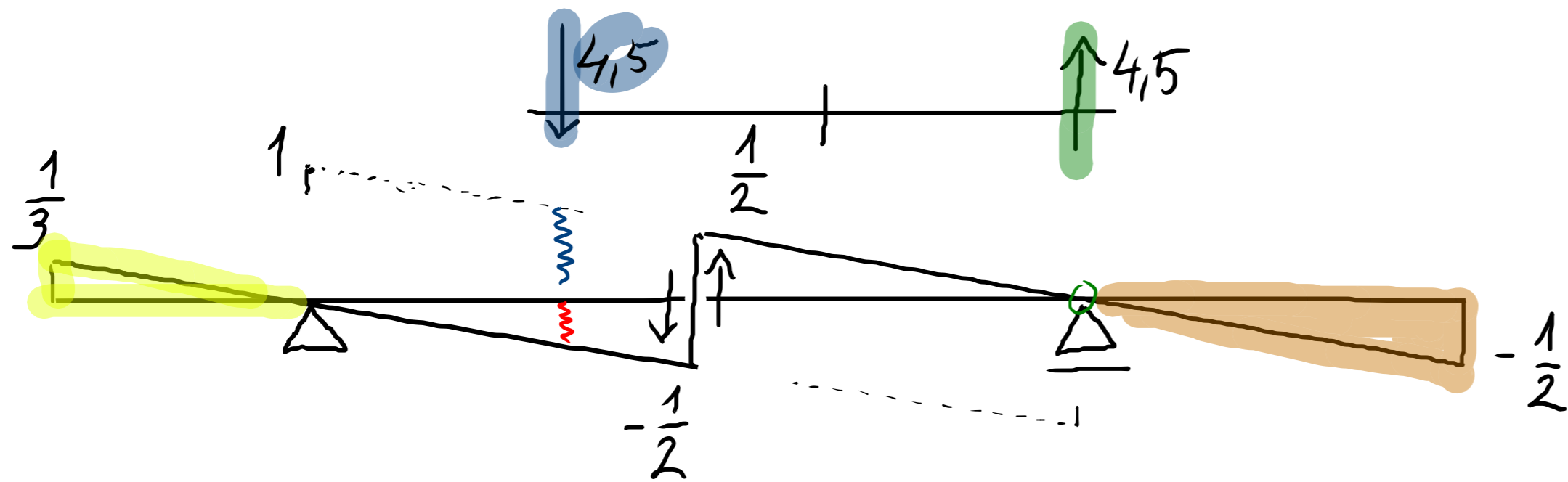

$$\begin{aligned}
 V_{x/2} &= \frac{1}{2} \cdot \frac{1}{3} \cdot 2 \cdot 5 + 12 \cdot \frac{2}{3} \left(-\frac{1}{2}\right) + \\
 &+ 4,5 \cdot \frac{4}{3} \cdot \frac{1}{2} - 4,5 \cdot 0 + \frac{1}{2} \cdot \left(-\frac{1}{2}\right) \cdot 3 \cdot \frac{2}{3} \cdot 10 = \\
 &= -4,3 \text{ kN}
 \end{aligned}$$

$M_{x/2}$

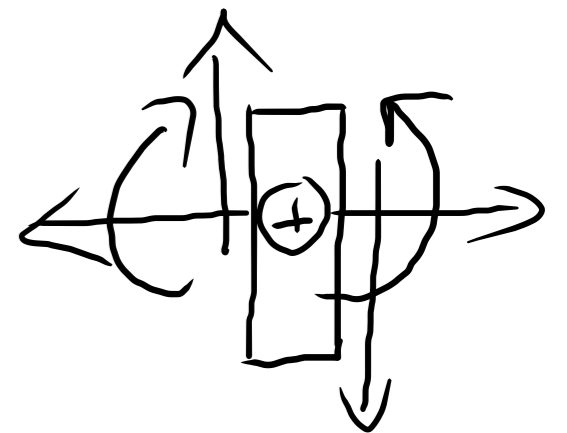
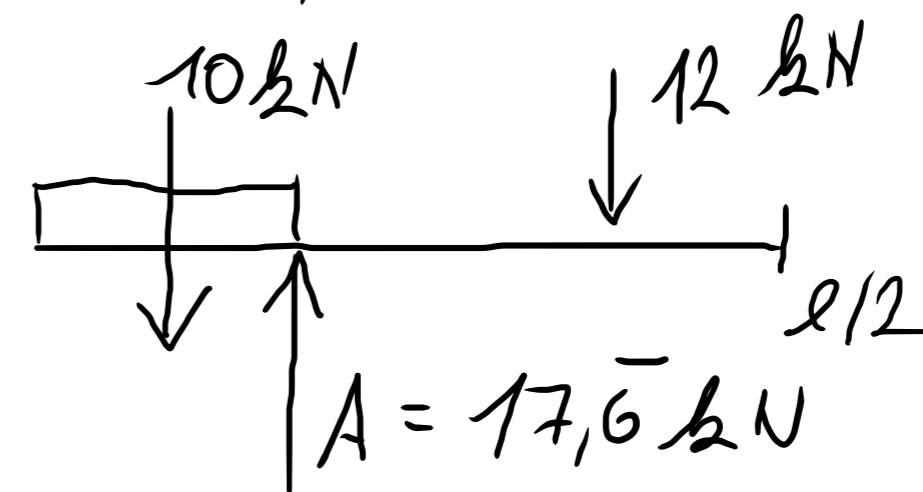
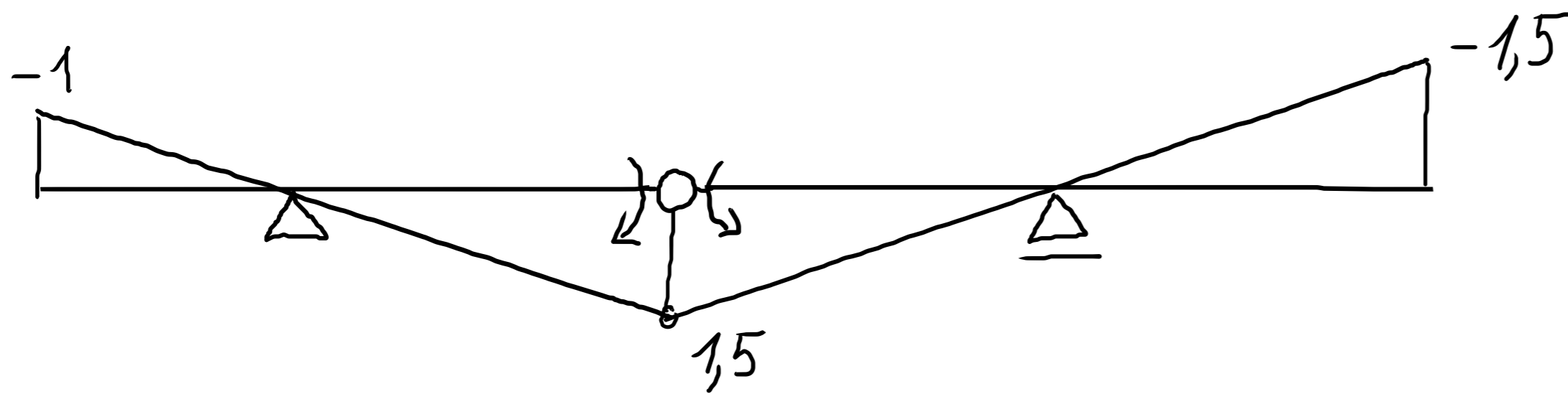

$$\uparrow \oplus V_{x/2} = -10 + 17,6 - 12 = -4,3 \text{ kN}$$

PŘÍČINKOVÉ ČÁRY - VÝPOČET VELIČIN

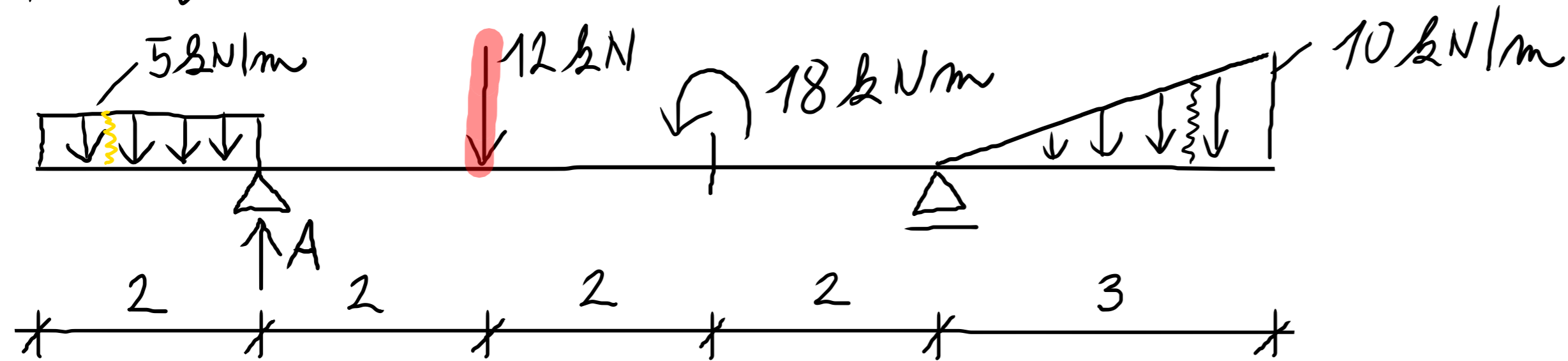

VYPOČÍTEJTE:

- REAKCE
- $V(x/2)$; $M(x/2)$

$V_{x/2}$

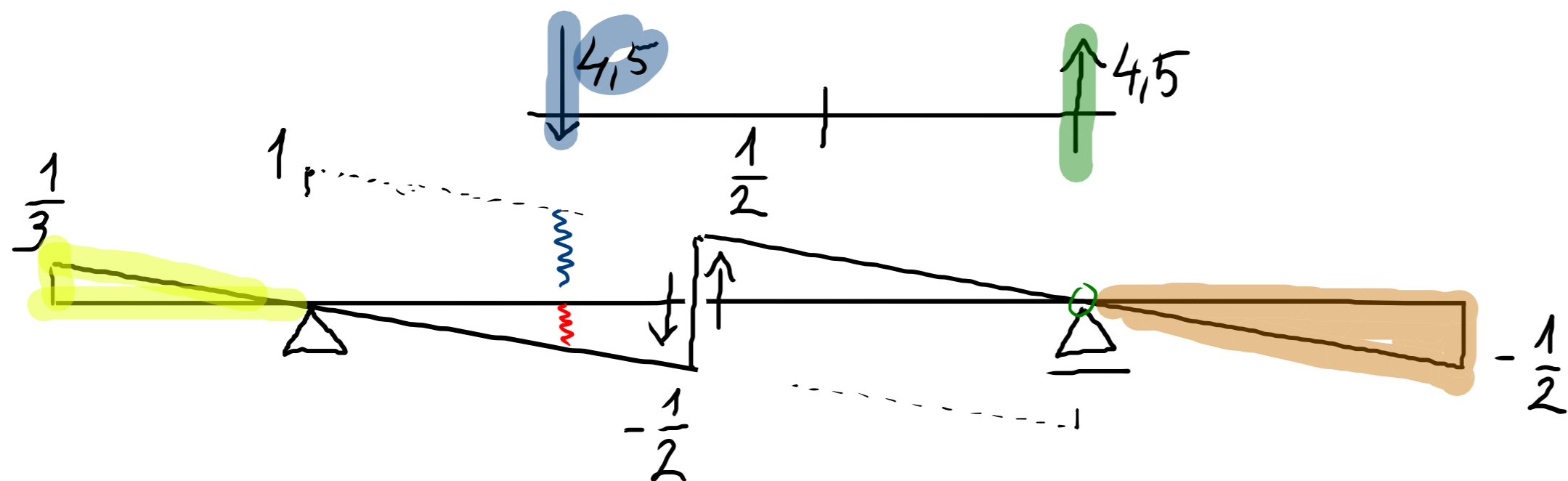

$$\begin{aligned}
 V_{x/2} &= \frac{1}{2} \cdot \frac{1}{3} \cdot 2 \cdot 5 + 12 \cdot \frac{2}{3} \left(-\frac{1}{2}\right) + \\
 &+ 4,5 \cdot \frac{4}{3} \cdot \frac{1}{2} - 4,5 \cdot 0 + \frac{1}{2} \cdot \left(-\frac{1}{2}\right) \cdot 3 \cdot \frac{2}{3} \cdot 10 = \\
 &= -4,3 \text{ kN}
 \end{aligned}$$

$M_{x/2}$

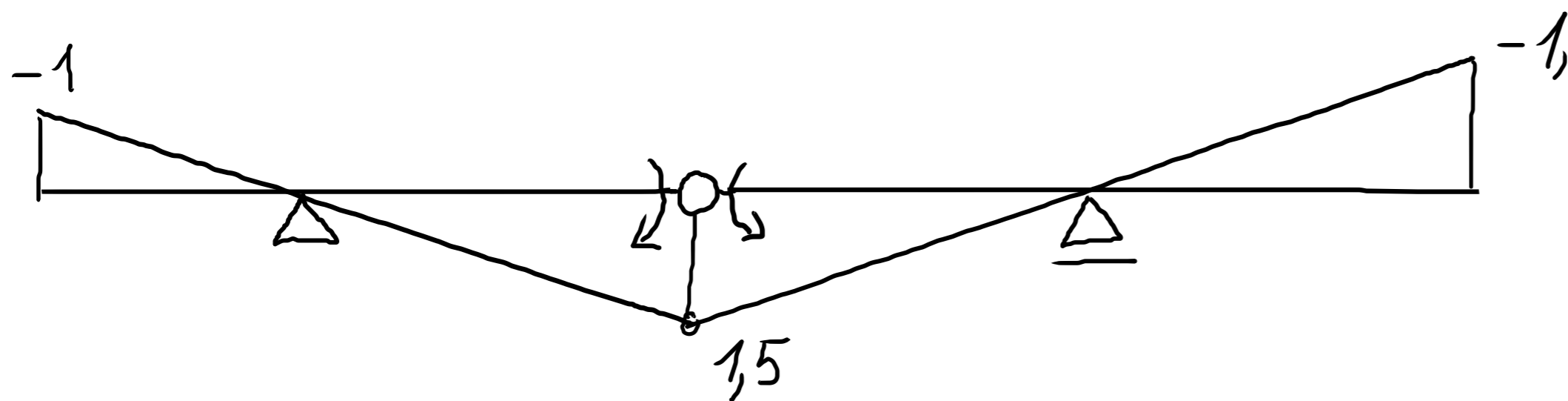

$$M_{x/2} = 1 \text{ kN}$$

PŘÍČINKOVÉ ČÁRY - S. N. - VYČÍSLENÍ

PŘÍČINKOVÉ ČÁRY - S. N. - VYČÍSLENÍ

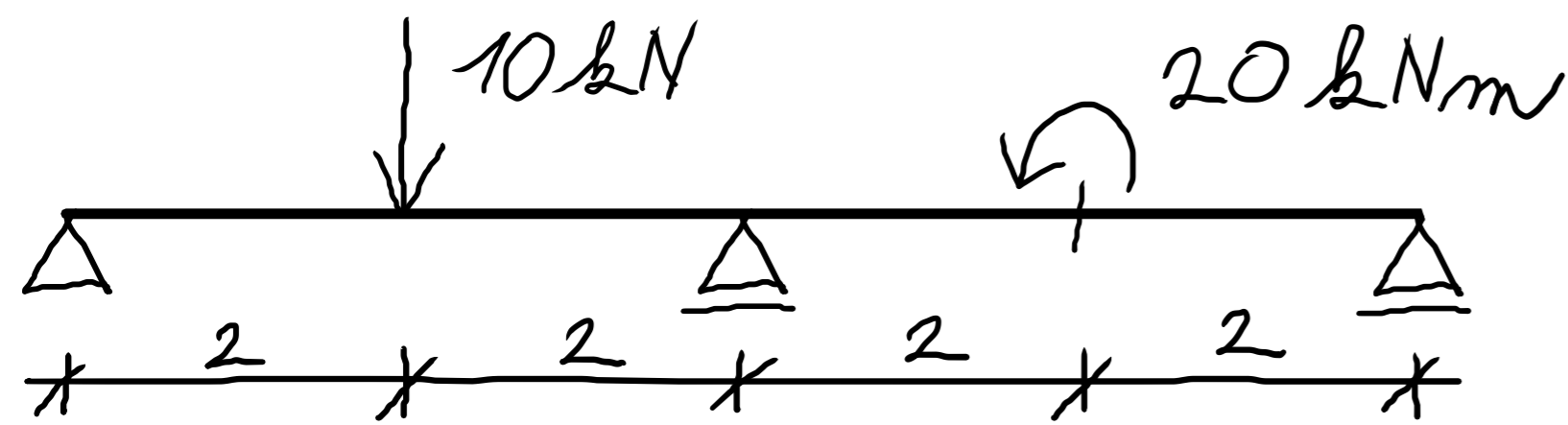

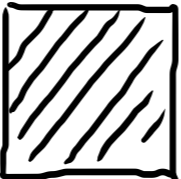
 0,2
0,2 [m]
 $E = 30 \text{ GPa}$

VYČÍSLETE PROSTŘEDNÍ REAKCI.

PŘÍČINKOVÉ ČÁRY - S. N. - VYČÍSLENÍ

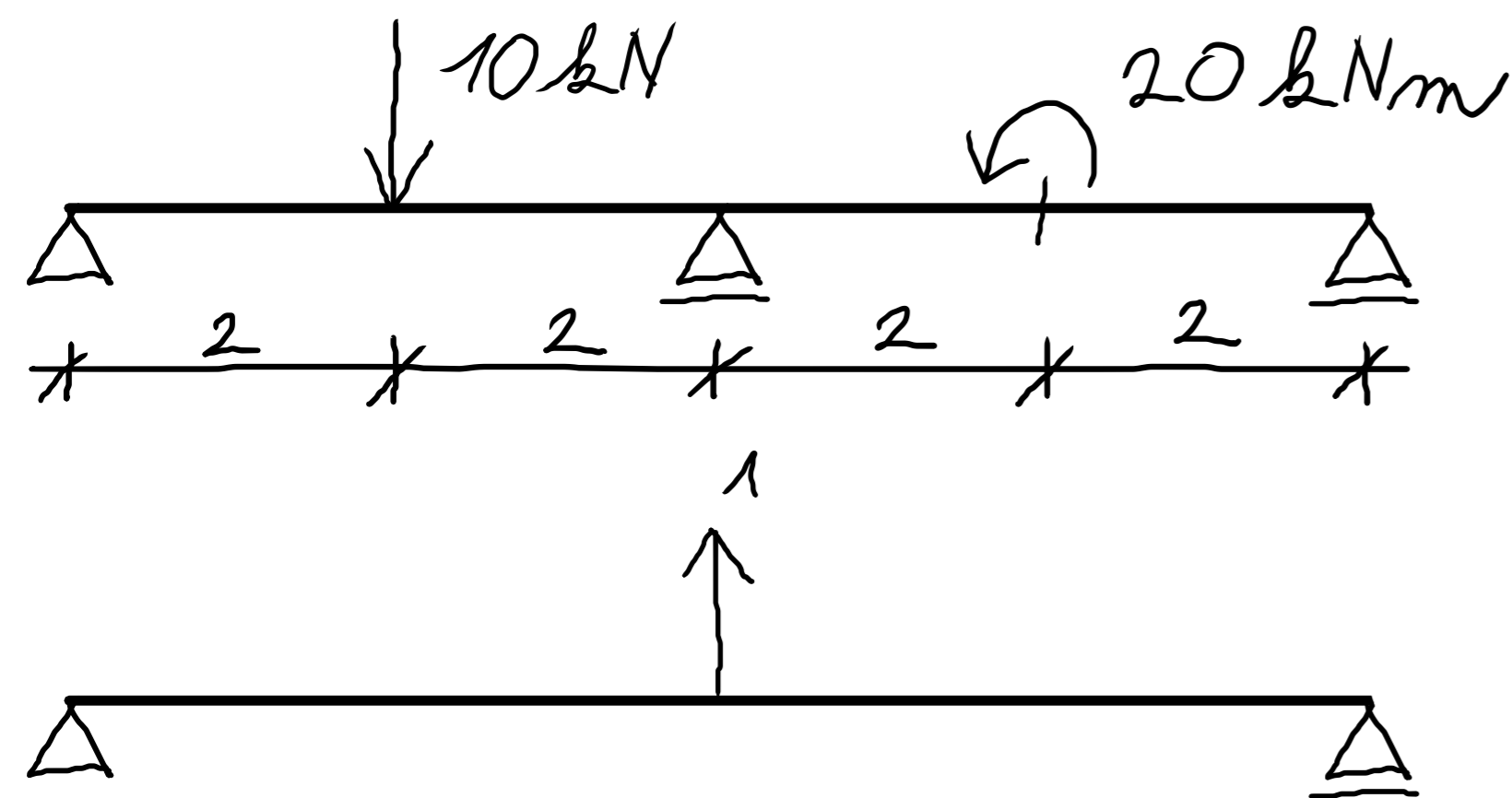

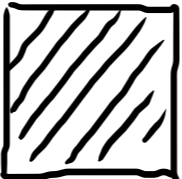
 0,2
0,2 [m]
 $E = 30 \text{ GPa}$

VYČÍSLETE PROSTŘEDNÍ REAKCI.

PŘÍČINKOVÉ ČÁRY - S. N. - VYČÍSLENÍ

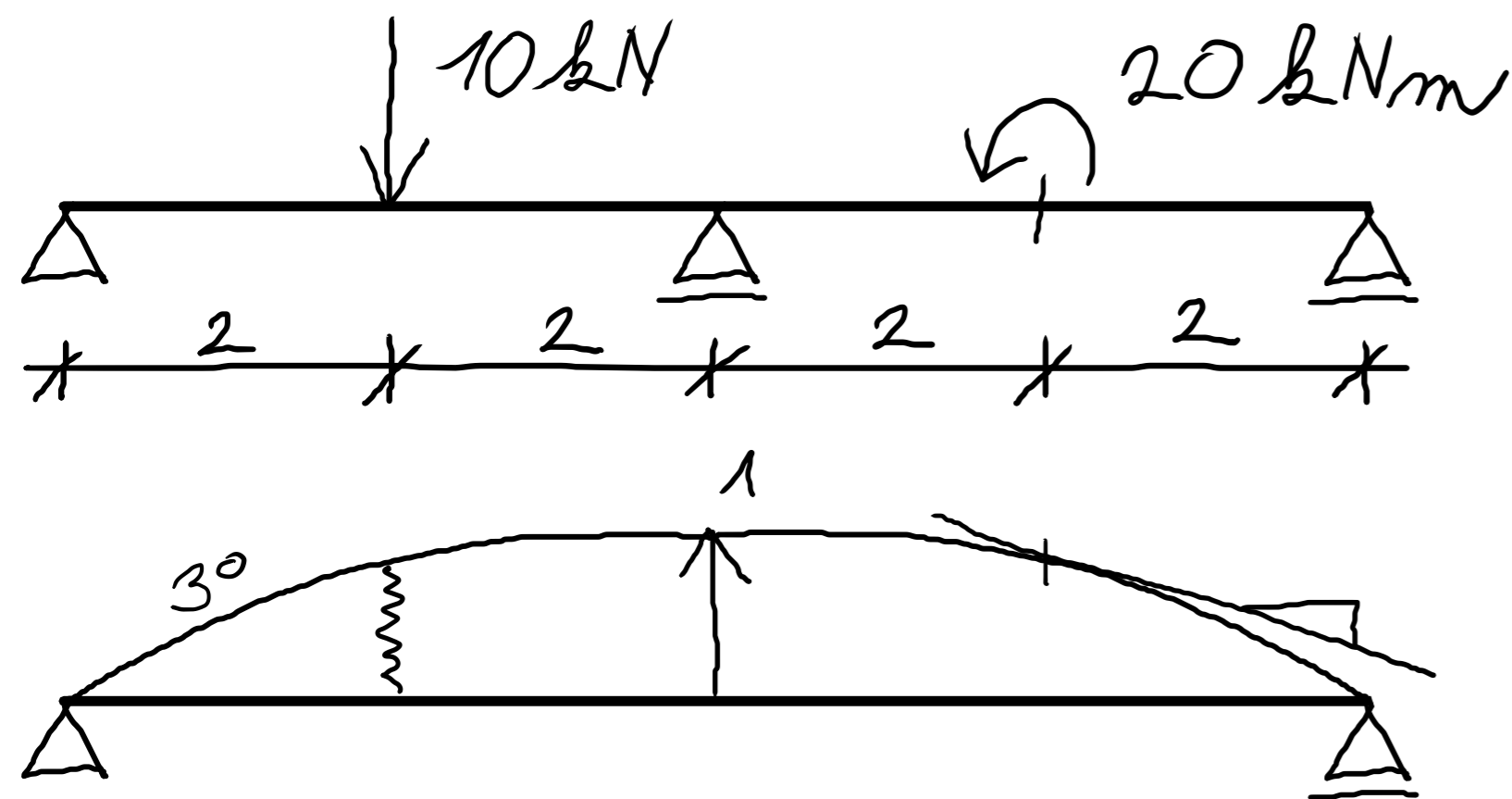

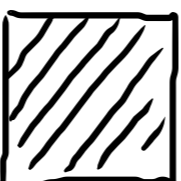
 0,2
0,2 [m]
 $E = 30 \text{ GPa}$

VYČÍSLETE PROSTŘEDNÍ REAKCI.

PŘÍČINKOVÉ ČÁRY - S. N. - VYČÍSLENÍ

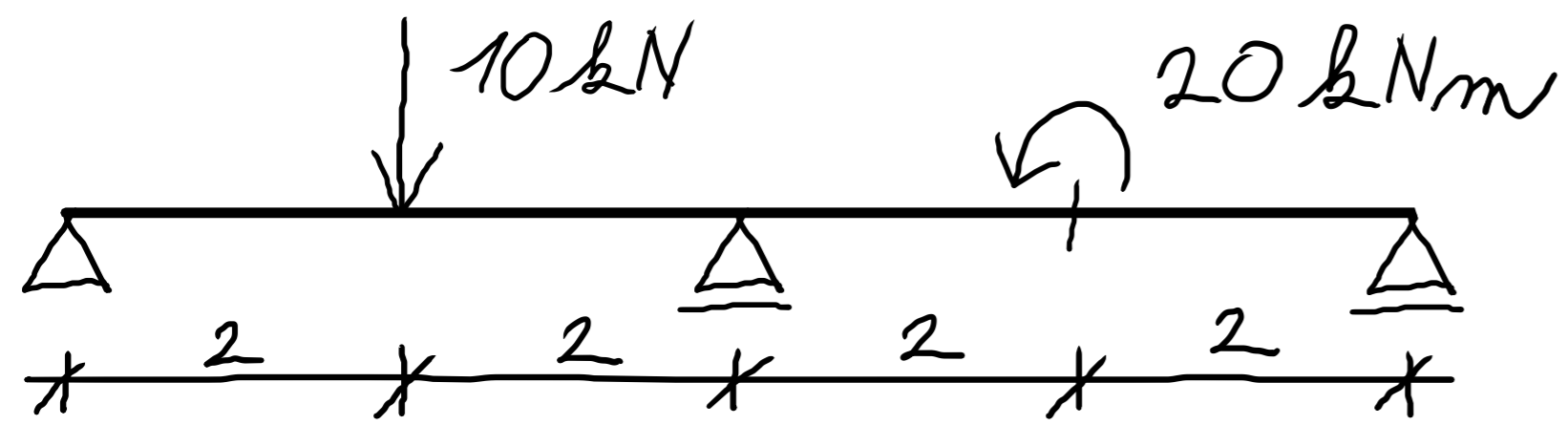

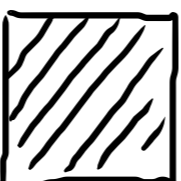
 0,2
 0,2 [m]
 $E = 30 \text{ GPa}$

VYČÍSLETE PROSTŘEDNÍ REAKCI

$$I = \frac{1}{12} \cdot 0,2 \cdot 0,2^3 = 1,3 \cdot 10^{-4} \text{ m}^4$$

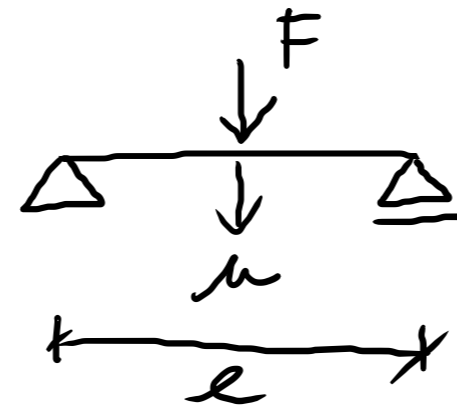
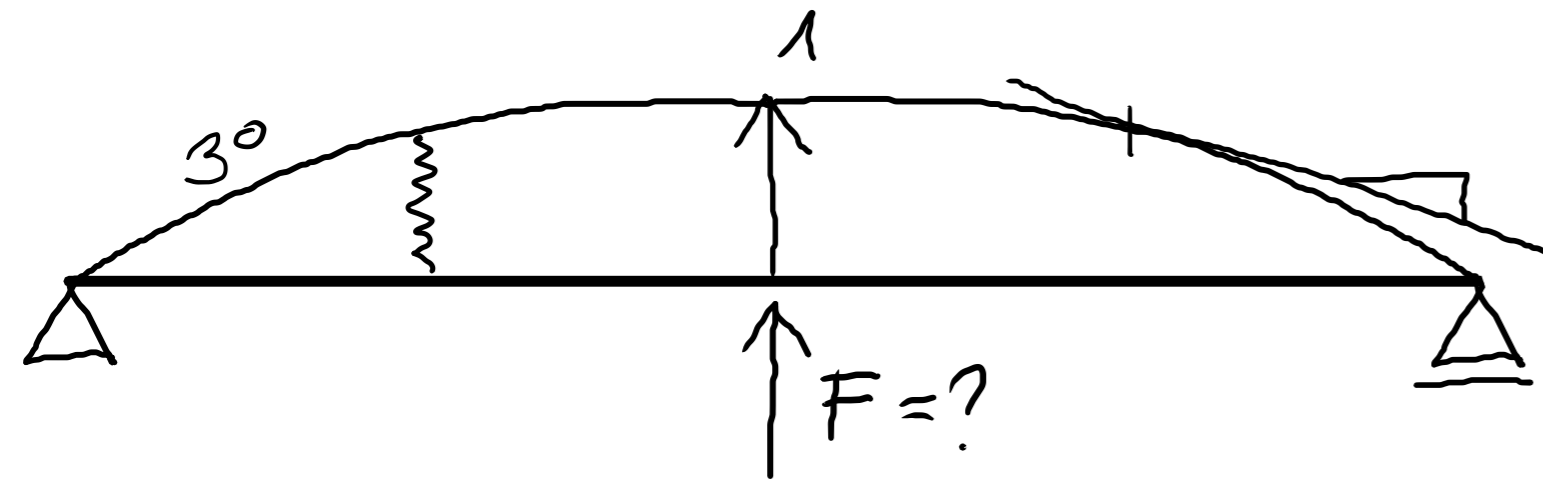

MJS: $w = \frac{Fl^3}{48EI} \rightarrow F = \frac{48EIw}{l^3}$

$$F = \frac{48 \cdot 30 \cdot 10^9 \cdot 1,3 \cdot 10^{-4}}{8^3} = 375\,000 \text{ N} = 375 \text{ kN}$$

PŘÍČINKOVÉ ČÁRY - S. N. - VYČÍSLENÍ

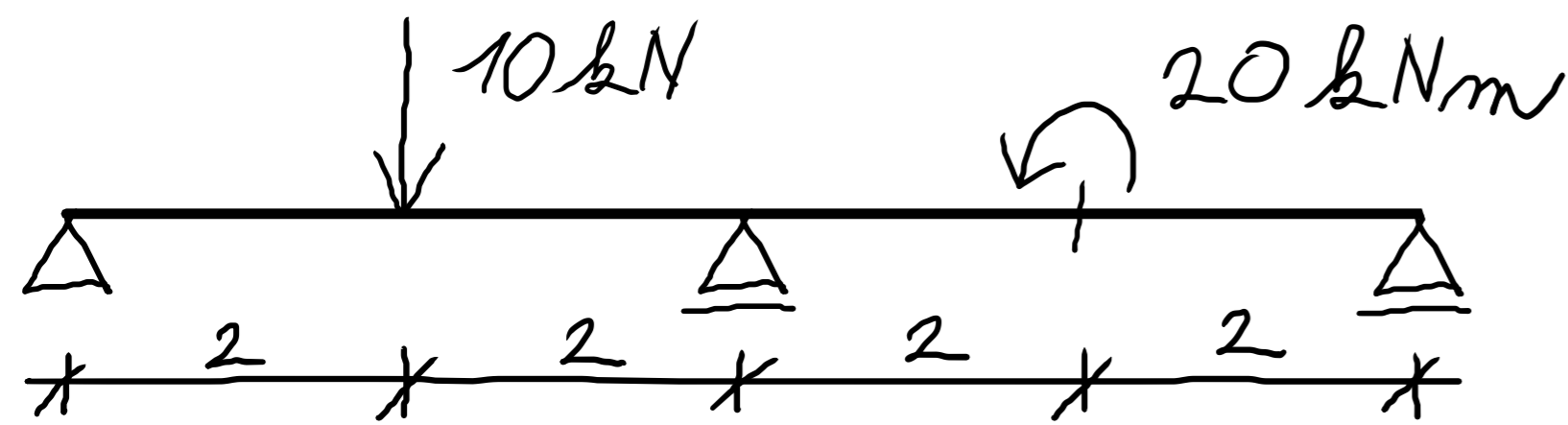

 0,2
 0,2 [m]
 $E = 30 \text{ GPa}$

VYČÍSLETE PROSTŘEDNÍ REAKCI

$$I = \frac{1}{12} \cdot 0,2 \cdot 0,2^3 = 1,3 \cdot 10^{-4} \text{ m}^4$$

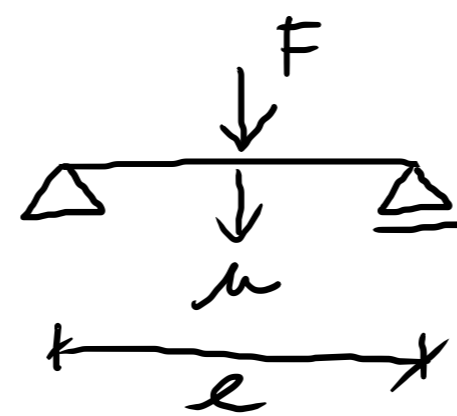
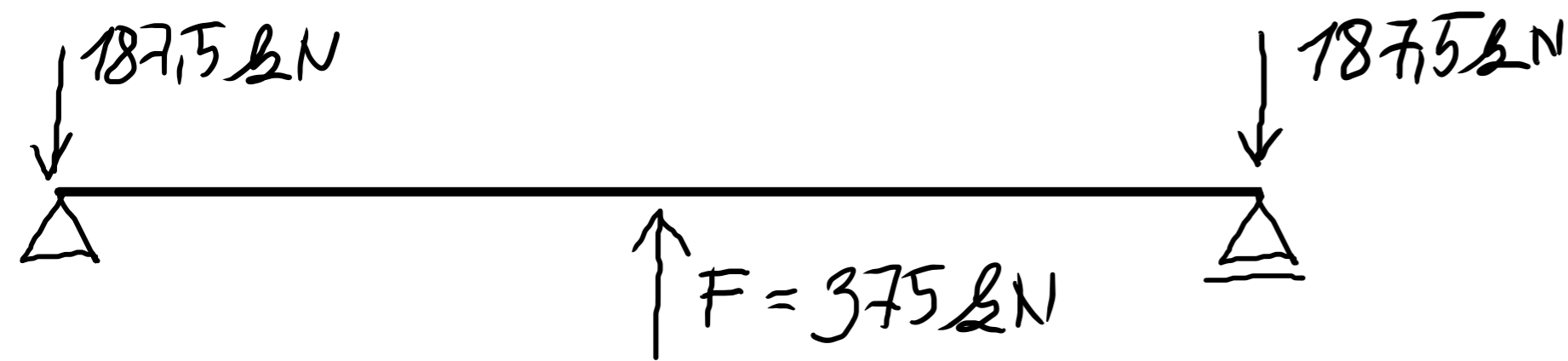

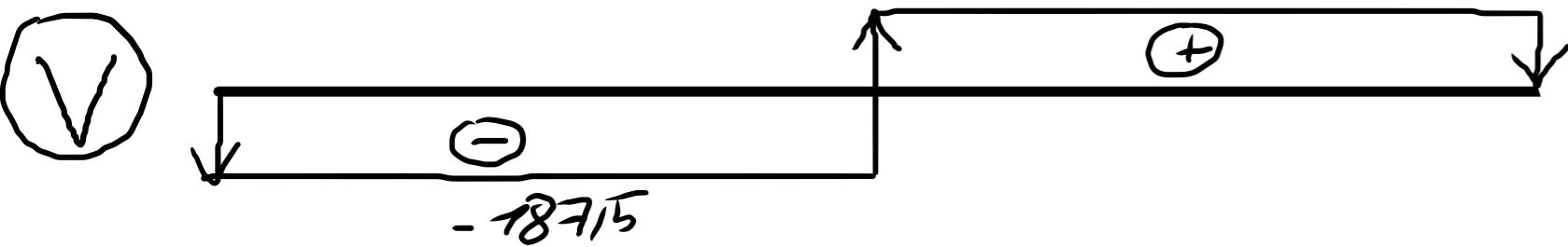

MJS: $w = \frac{Fl^3}{48EI} \rightarrow F = \frac{48EIw}{l^3}$

$$F = \frac{48 \cdot 30 \cdot 10^9 \cdot 1,3 \cdot 10^{-4}}{8^3} = 375\,000 \text{ N} = 375 \text{ kN}$$

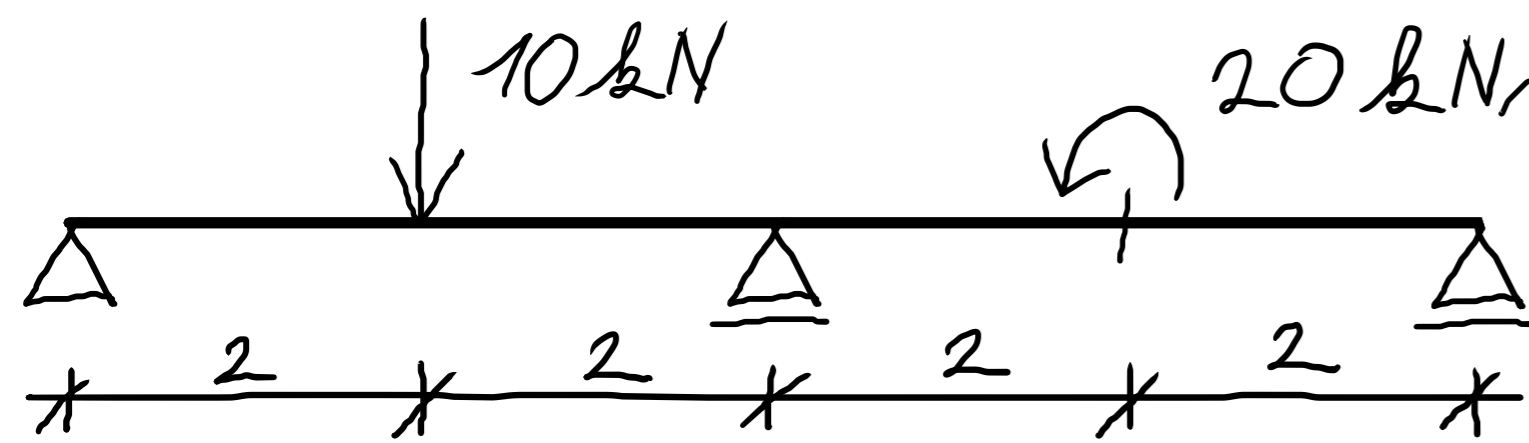

PŘÍČINKOVÉ ČÁRY - S. N. - VYČÍSLENÍ



 0,2
 0,2 [m]
 $E = 30 \text{ GPa}$

VYČÍSLETE PROSTŘEDNÍ REAKCI

$$I = \frac{1}{12} \cdot 0,2 \cdot 0,2^3 = 1,3 \cdot 10^{-4} \text{ m}^4$$

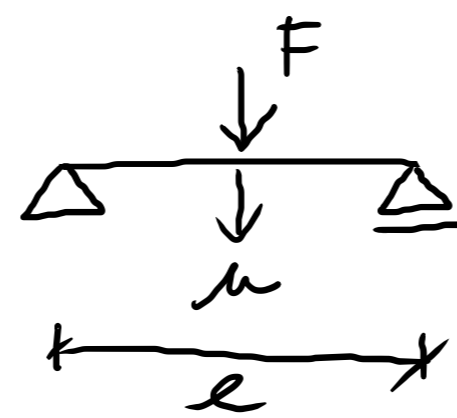
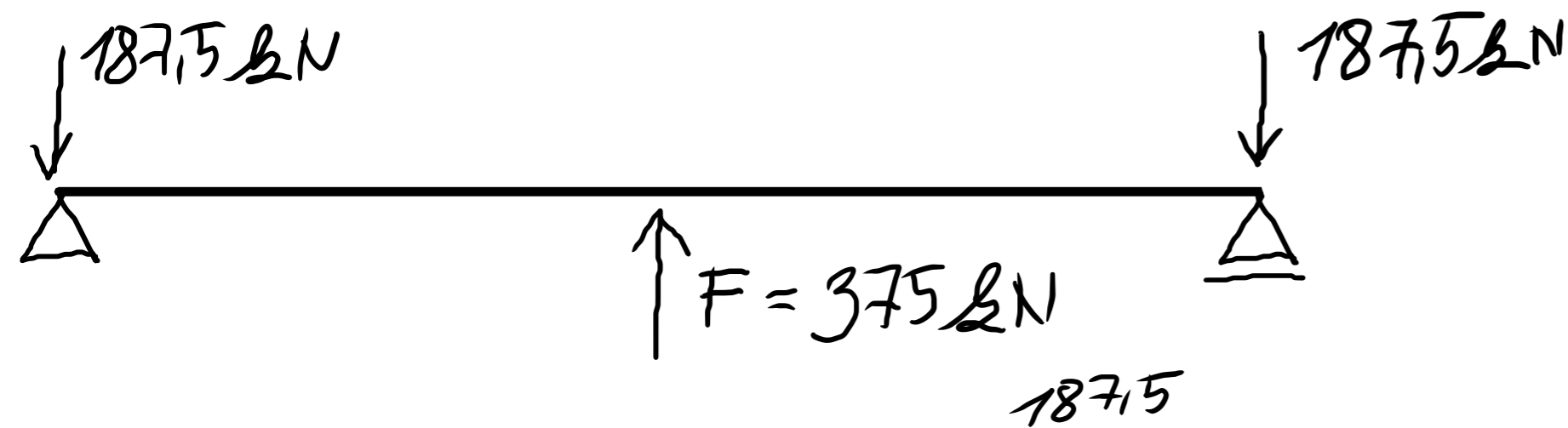

MJS: $w = \frac{Fl^3}{48EI} \rightarrow F = \frac{48EIw}{l^3}$

$$F = \frac{48 \cdot 30 \cdot 10^9 \cdot 1,3 \cdot 10^{-4}}{8^3} = 375\,000 \text{ N} = 375 \text{ kN}$$

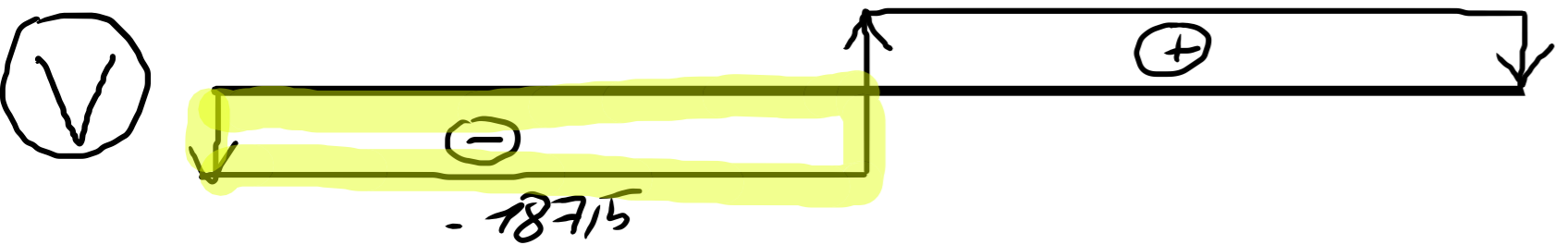

$$0 - 1875 \cdot 4 = -7500$$



PŘÍČINKOVÉ ČÁRY - S. N. - VYČÍSLENÍ

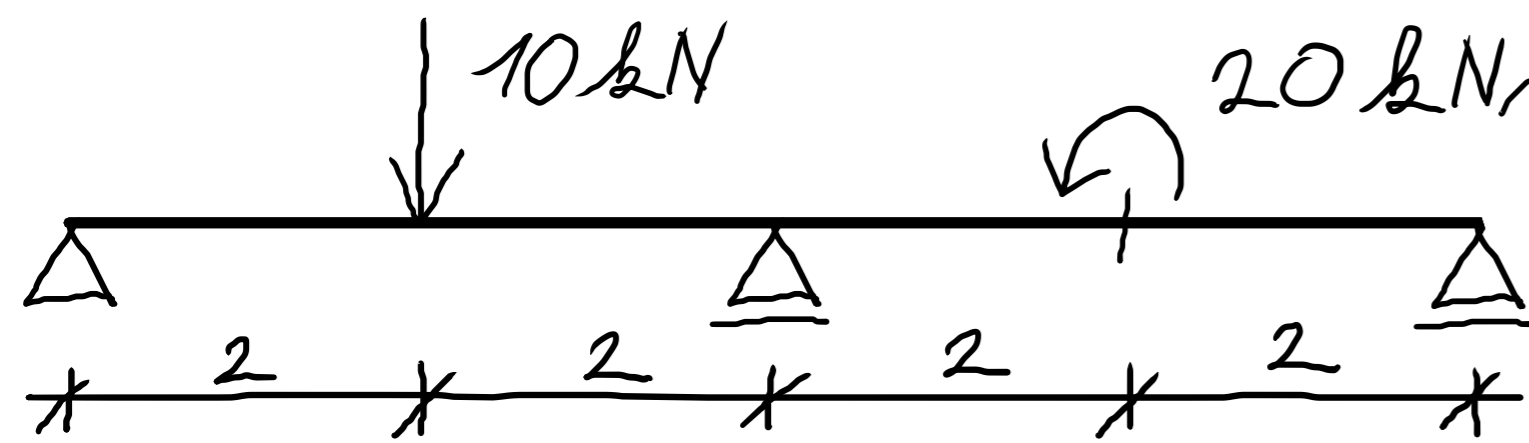

 0,2
 0,2 [m]
 $E = 30 \text{ GPa}$

VYČÍSLETE PROSTŘEDNÍ REAKCI

$$I = \frac{1}{12} \cdot 0,2 \cdot 0,2^3 = 1,3 \cdot 10^{-4} \text{ m}^4$$

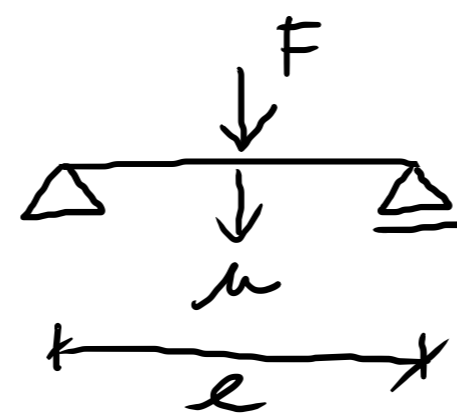
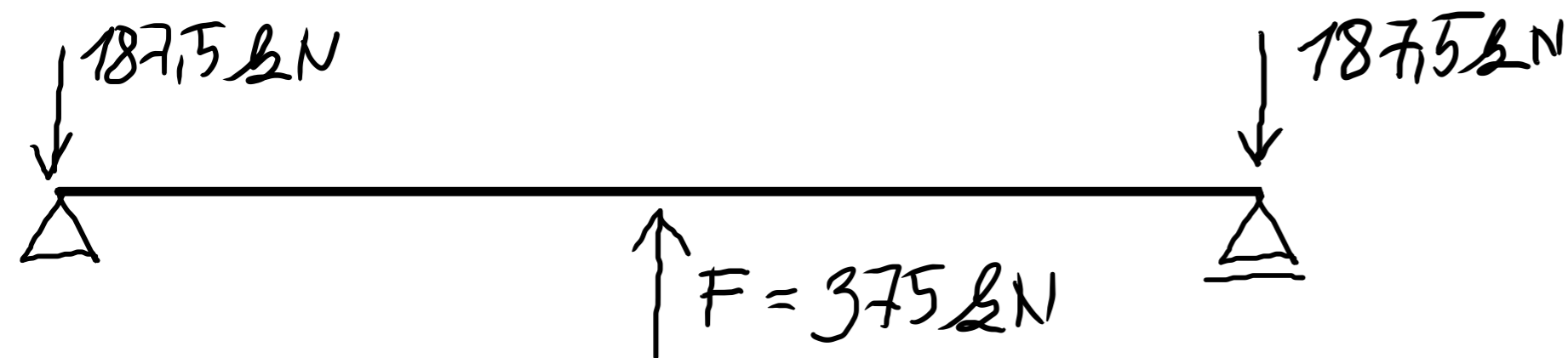

MJS: $w = \frac{Fl^3}{48EI} \rightarrow F = \frac{48EIw}{l^3}$

$$F = \frac{48 \cdot 30 \cdot 10^9 \cdot 1,3 \cdot 10^{-4}}{8^3} = 375\,000 \text{ N} = 375 \text{ kN}$$

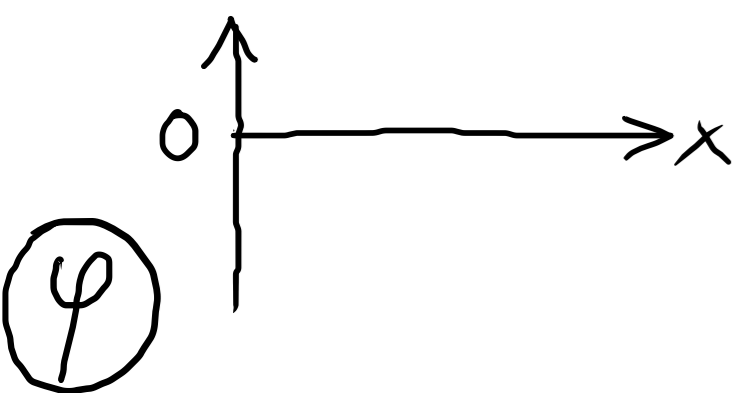
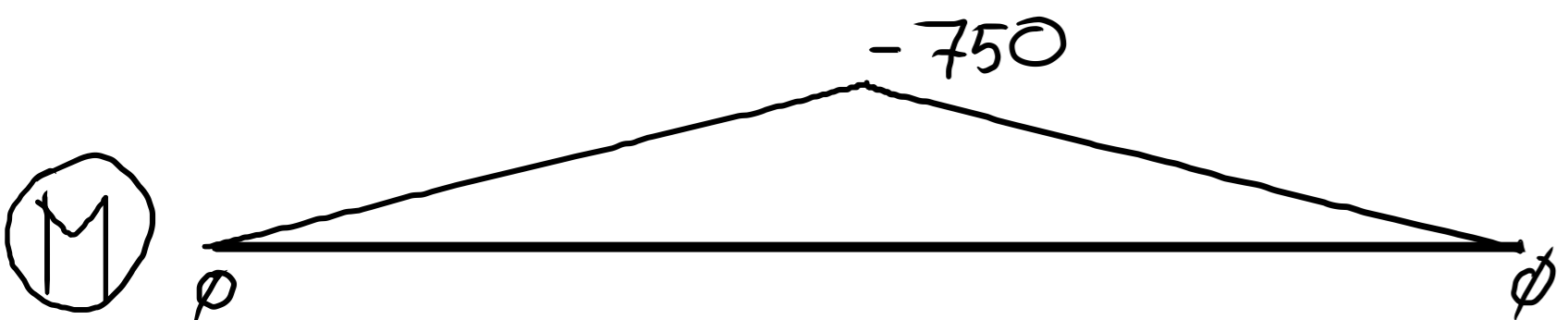
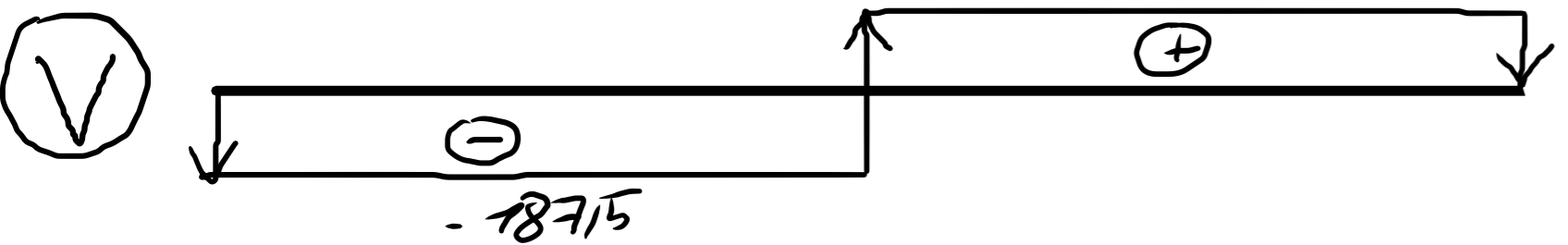

1) $\varphi^* = \int_0^8 \frac{M}{EI} dx =$

2) c

PŘÍČINKOVÉ ČÁRY - S. N. - VYČÍSLENÍ

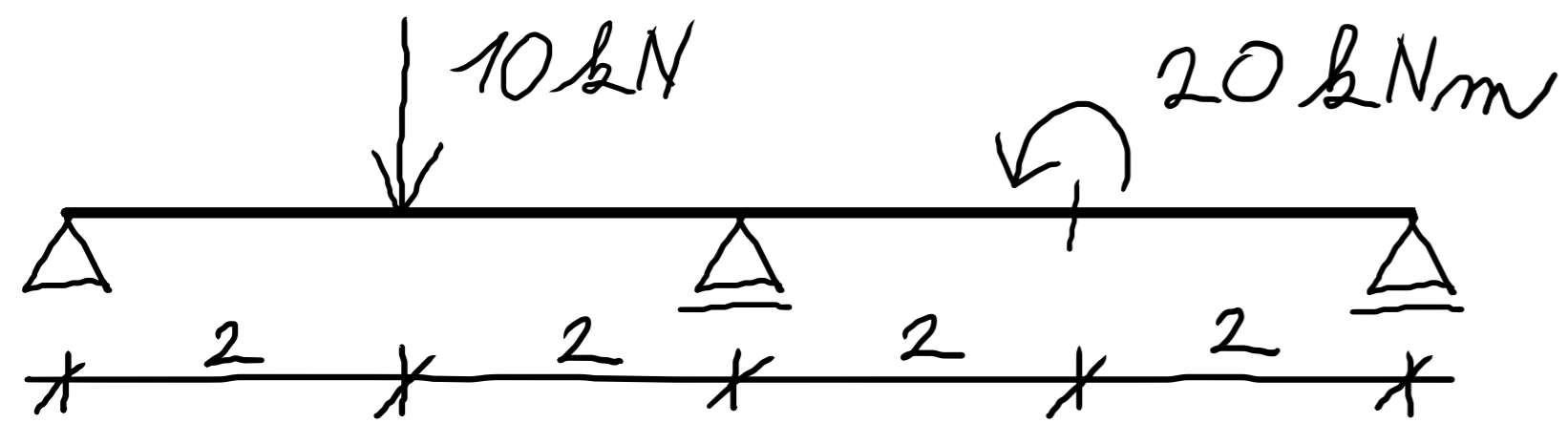

 0,2
 0,2 [m]
 $E = 30 \text{ GPa}$

VYČÍSLETE PROSTŘEDNÍ REAKCI

$$I = \frac{1}{12} \cdot 0,2 \cdot 0,2^3 = 1,3 \cdot 10^{-4} \text{ m}^4$$

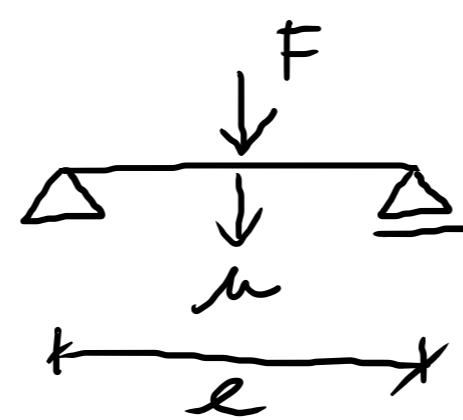
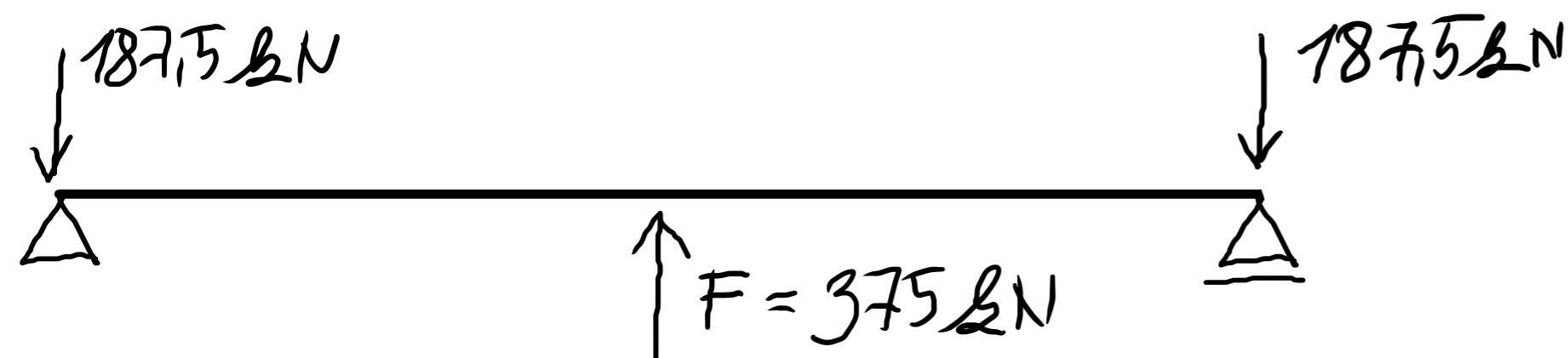

MJS: $w = \frac{Fl^3}{48EI} \rightarrow F = \frac{48EIw}{l^3}$

$$F = \frac{48 \cdot 30 \cdot 10^9 \cdot 1,3 \cdot 10^{-4}}{8^3} = 375\,000 \text{ N} = 375 \text{ kN}$$

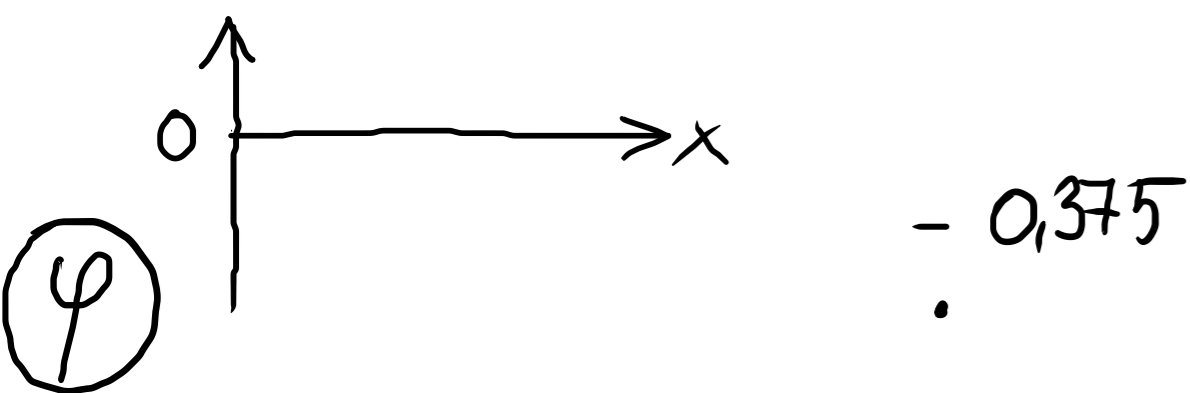
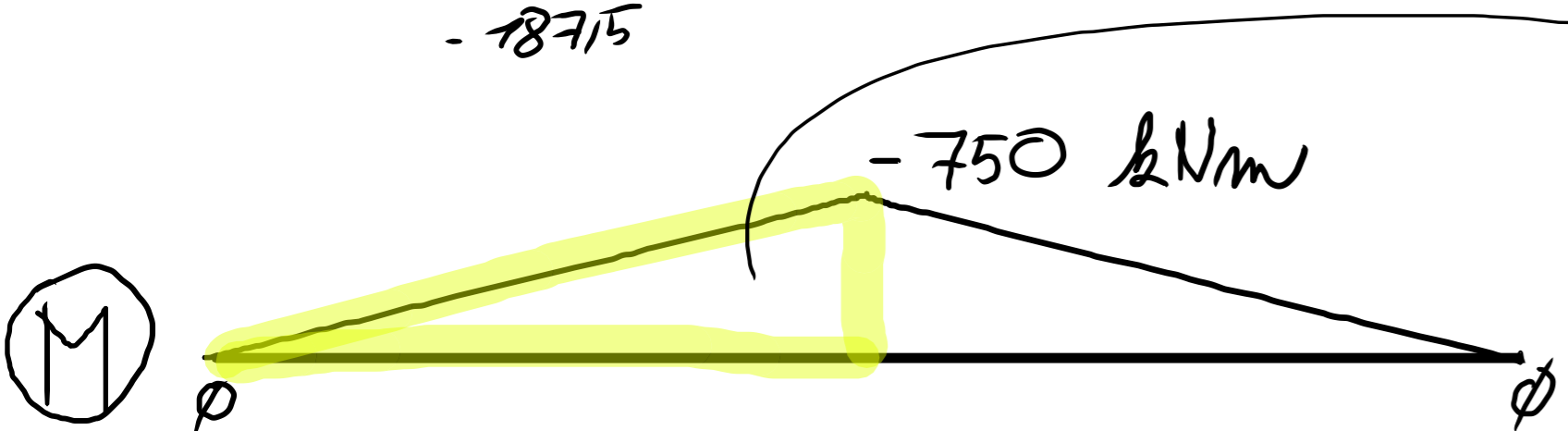
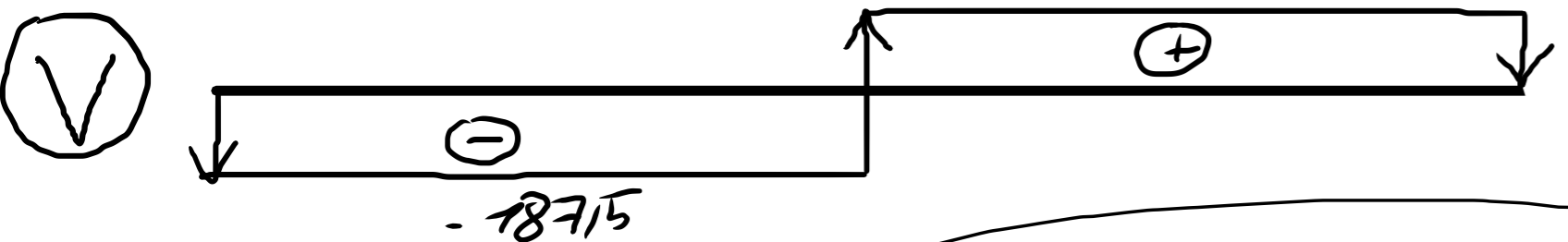

$$\frac{1}{2} (-750) \cdot 4 = -1500 \text{ kNm}^2$$

$$\frac{-1500 \cdot 10^3}{30 \cdot 10^9 \cdot 1,3 \cdot 10^{-4}} = -0,375 \text{ rad}$$

$$1) \varphi = \int_0^8 \frac{M}{EI} dx = \frac{1}{EI} \left(\int_0^4 M dx + \int_4^8 M dx \right)$$

2) c

PŘÍČINKOVÉ ČÁRY - S. N. - VYČÍSLENÍ

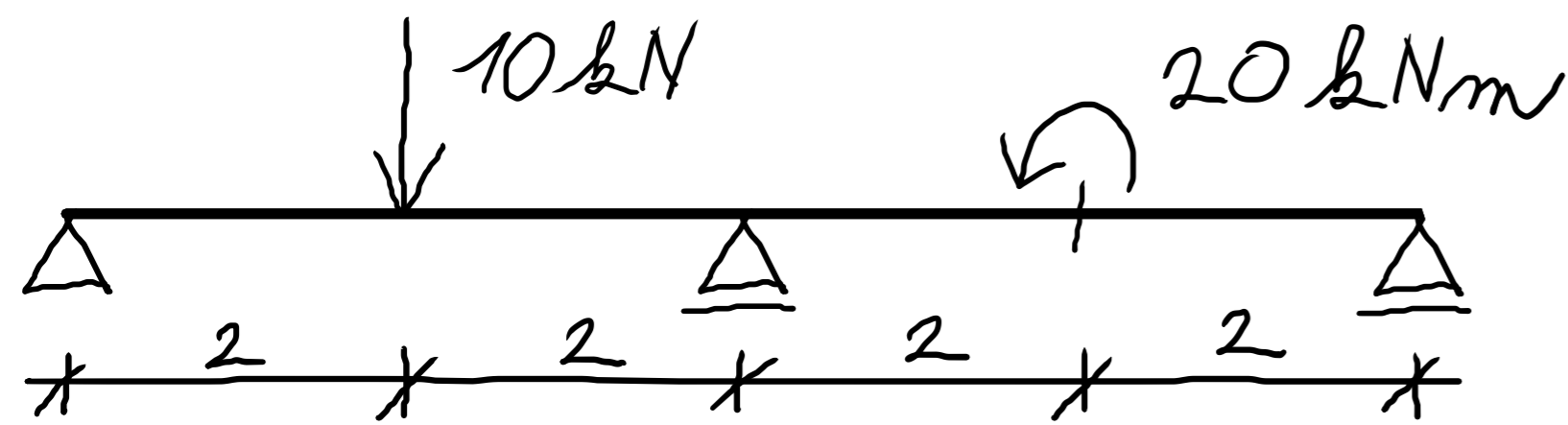

 0,2
 0,2 [m]
 $E = 30 \text{ GPa}$

VYČÍSLETE PROSTŘEDNÍ REAKCI

$$I = \frac{1}{12} \cdot 0,2 \cdot 0,2^3 = 1,3 \cdot 10^{-4} \text{ m}^4$$

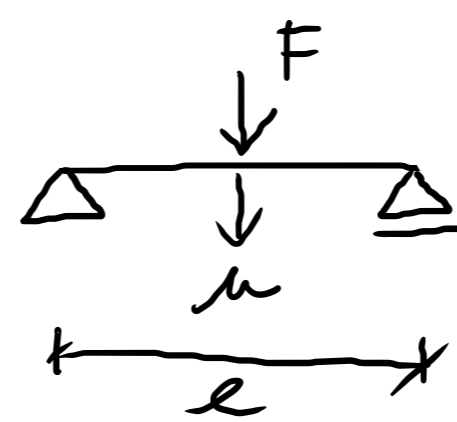
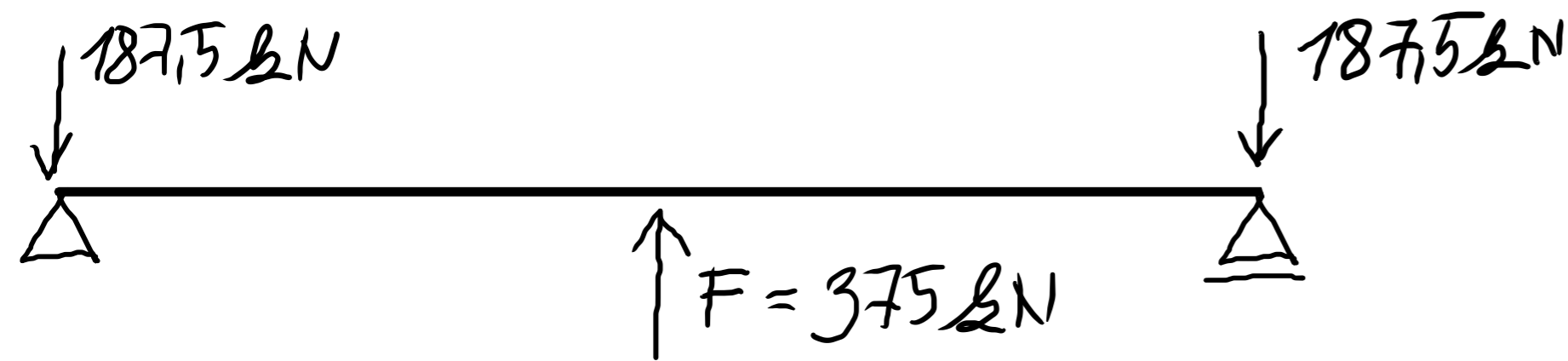

MJS: $w = \frac{Fl^3}{48EI} \rightarrow F = \frac{48EIw}{l^3}$

$$F = \frac{48 \cdot 30 \cdot 10^9 \cdot 1,3 \cdot 10^{-4}}{8^3} = 375\,000 \text{ N} = 375 \text{ kN}$$

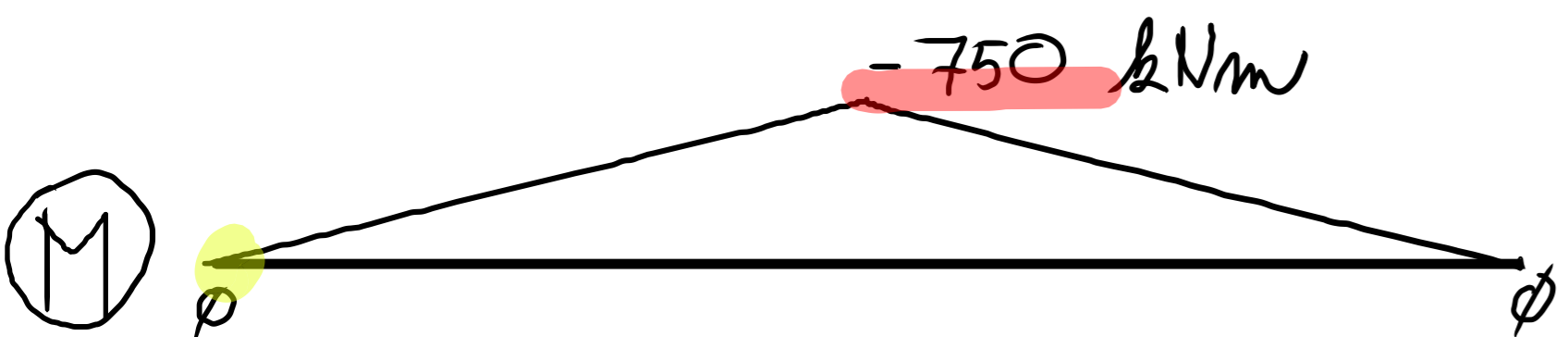
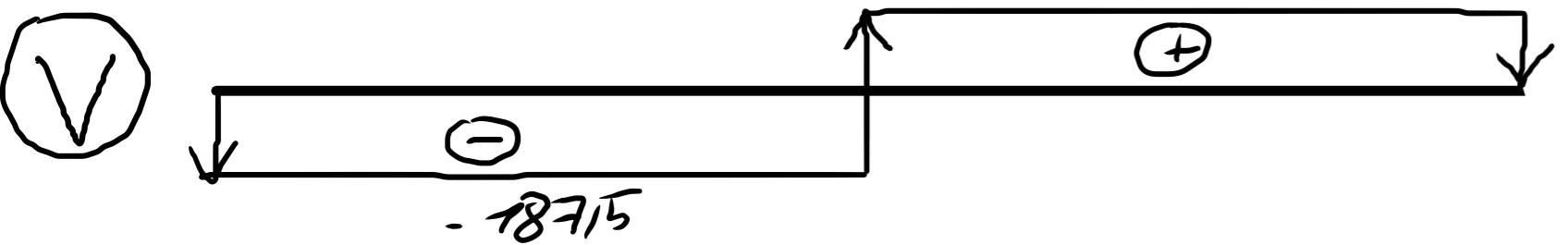

$$\frac{-750\,000}{30 \cdot 10^9 \cdot 1,3 \cdot 10^{-4}} = -0,1875 \text{ rad/m}$$

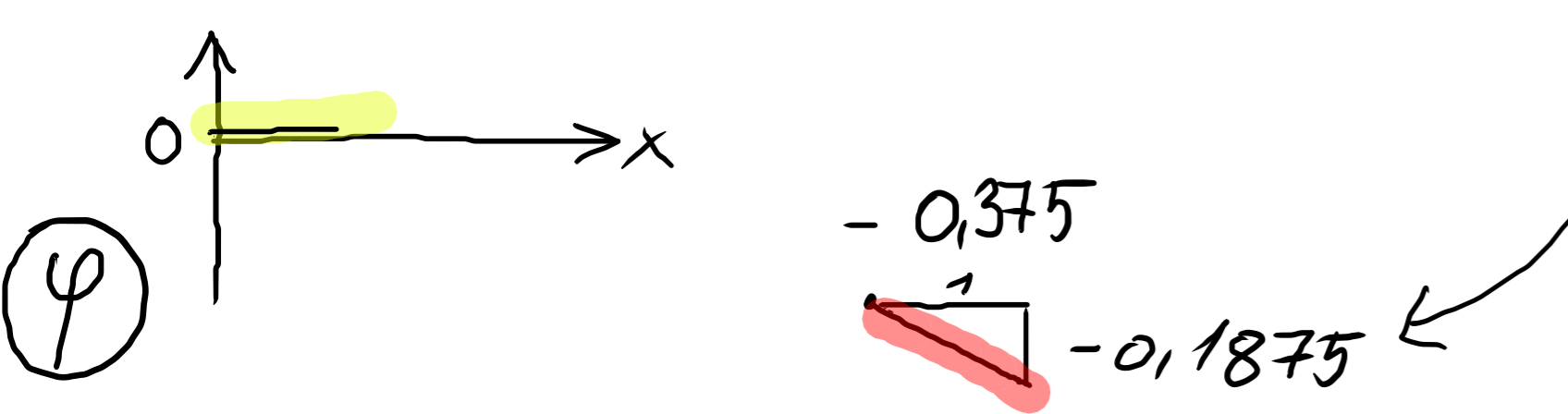

$$1) \varphi = \int_0^8 \frac{M}{EI} dx = \frac{1}{EI} \left(\int_0^4 M dx + \int_4^8 M dx \right)$$

2) c

PŘÍČINKOVÉ ČÁRY - S. N. - VYČÍSLENÍ

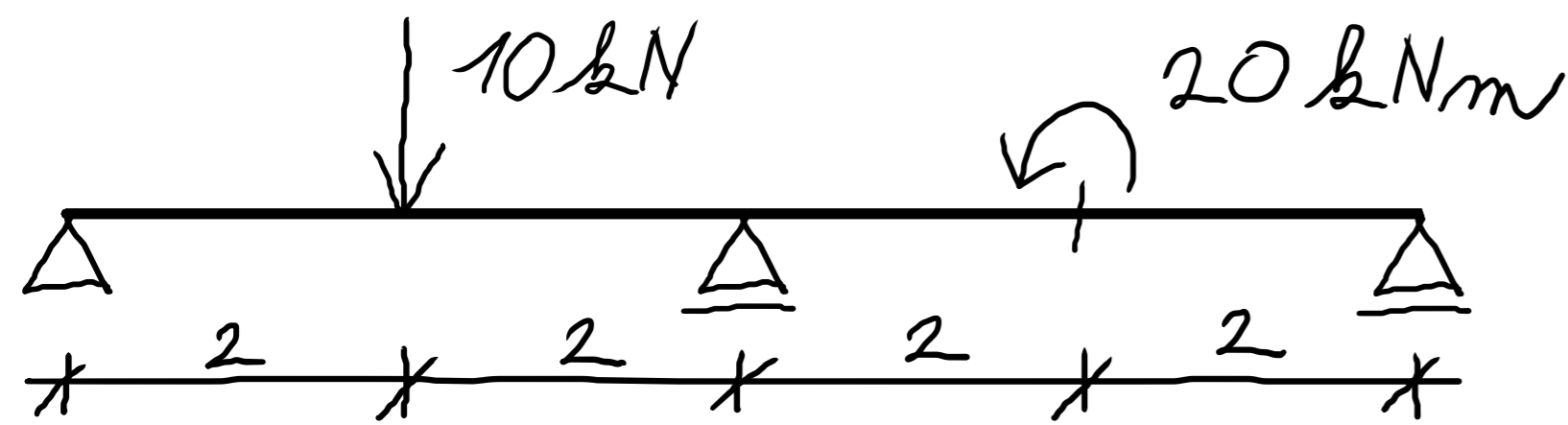

$0,2$
 $0,2 \text{ [m]}$
 $E = 30 \text{ GPa}$

VYČÍSLETE PROSTŘEDNÍ REAKCI

$$I = \frac{1}{12} \cdot 0,2 \cdot 0,2^3 = 1,3 \cdot 10^{-4} \text{ m}^4$$

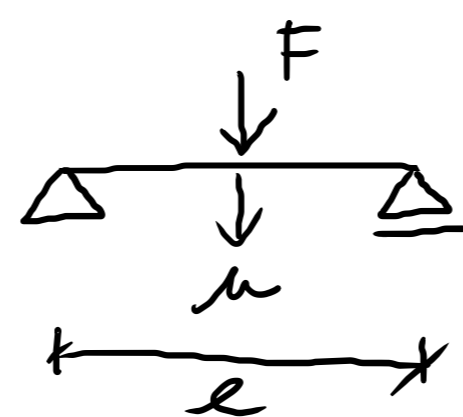
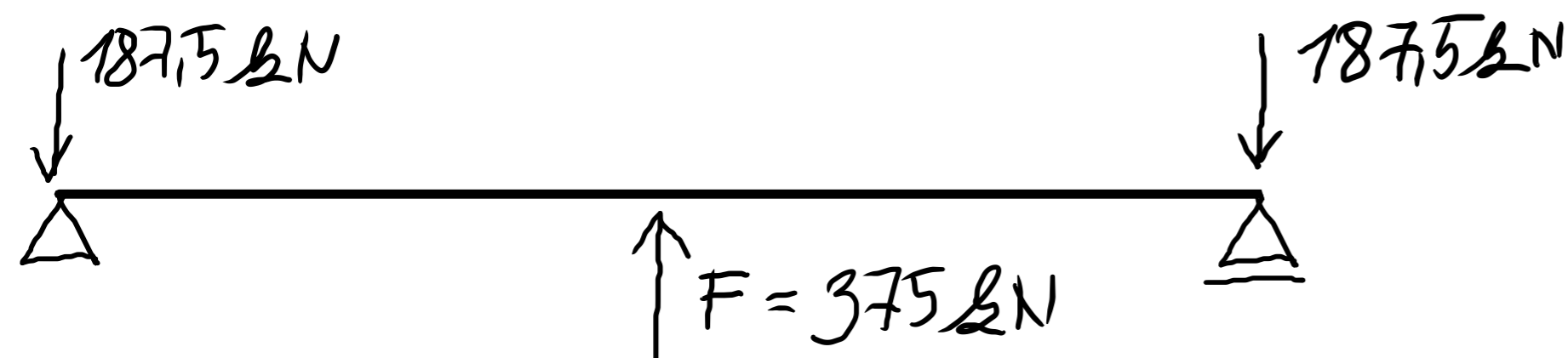

MJS: $w = \frac{Fl^3}{48EI} \rightarrow F = \frac{48EIw}{l^3}$

$$F = \frac{48 \cdot 30 \cdot 10^9 \cdot 1,3 \cdot 10^{-4}}{8^3} = 375\,000 \text{ N} = 375 \text{ kN}$$

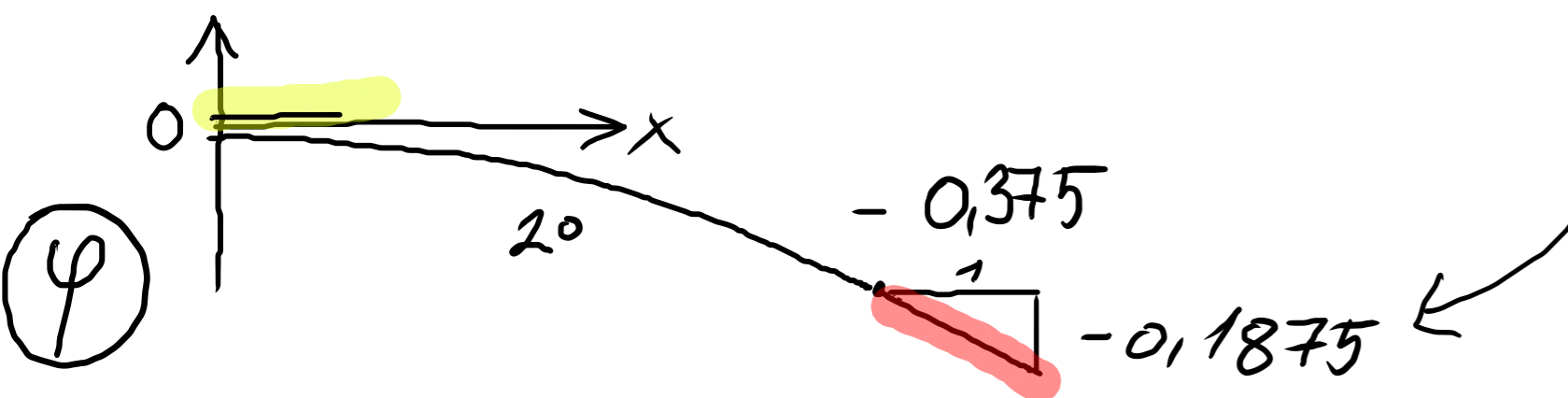
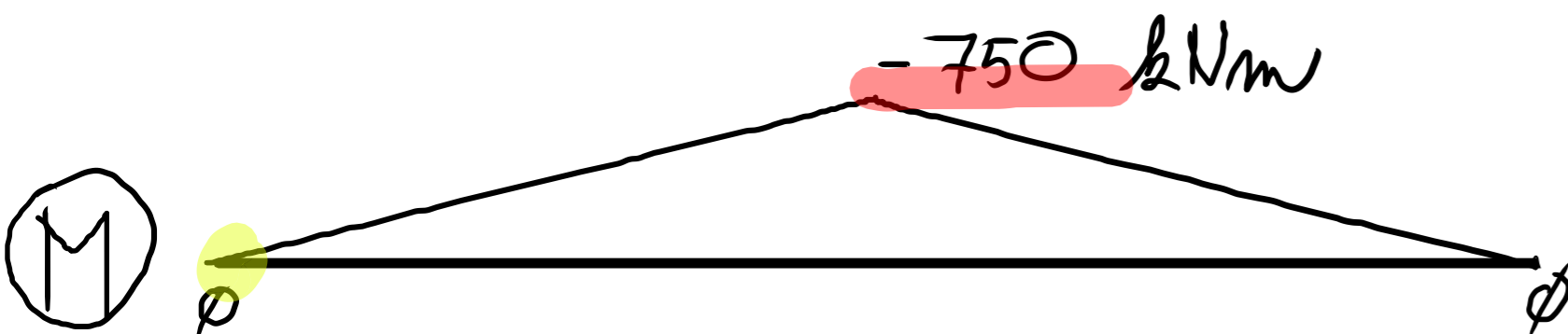
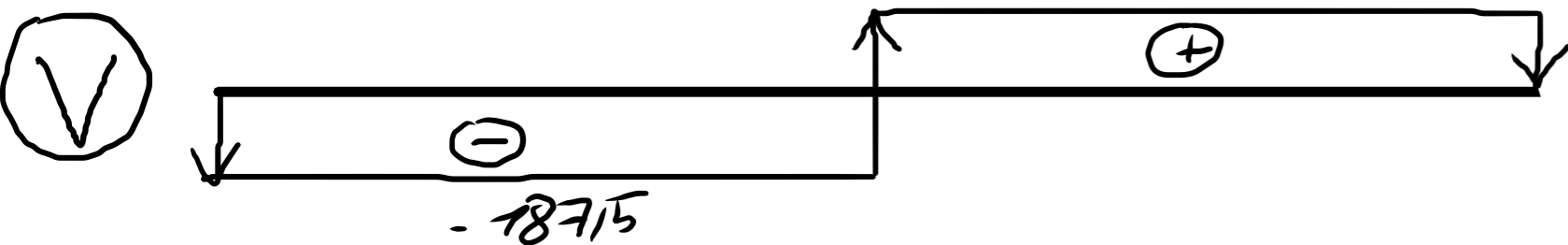

$$\frac{-750\,000}{30 \cdot 10^9 \cdot 1,3 \cdot 10^{-4}} = -0,1875 \text{ rad/m}$$

$$1) \varphi^* = \int_0^8 \frac{M}{EI} dx = \frac{1}{EI} \left(\int_0^4 M dx + \int_4^8 M dx \right)$$

2) c

PŘÍČINKOVÉ ČÁRY - S. N. - VYČÍSLENÍ

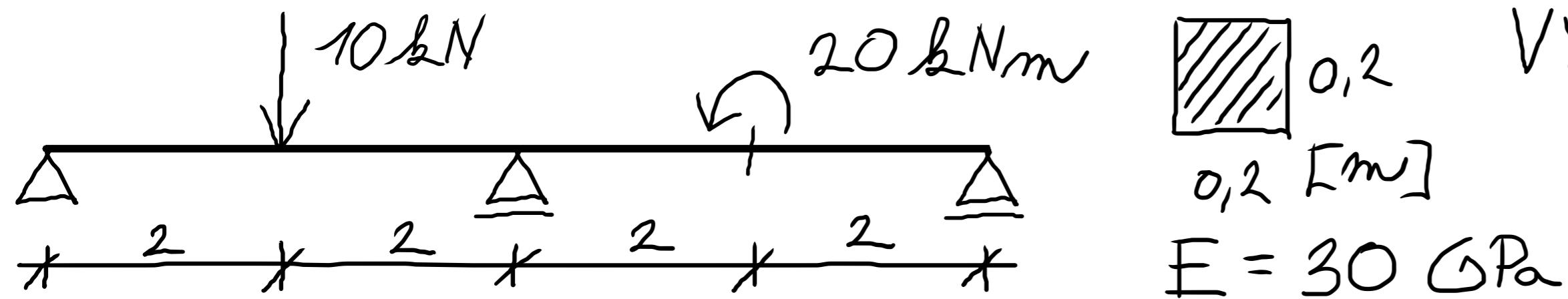

VYČÍSLETE PROSTŘEDNÍ REAKCI

$$I = \frac{1}{12} \cdot 0,2 \cdot 0,2^3 = 1,3 \cdot 10^{-4} \text{ m}^4$$

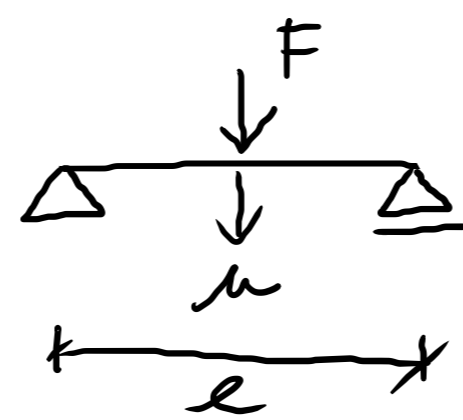
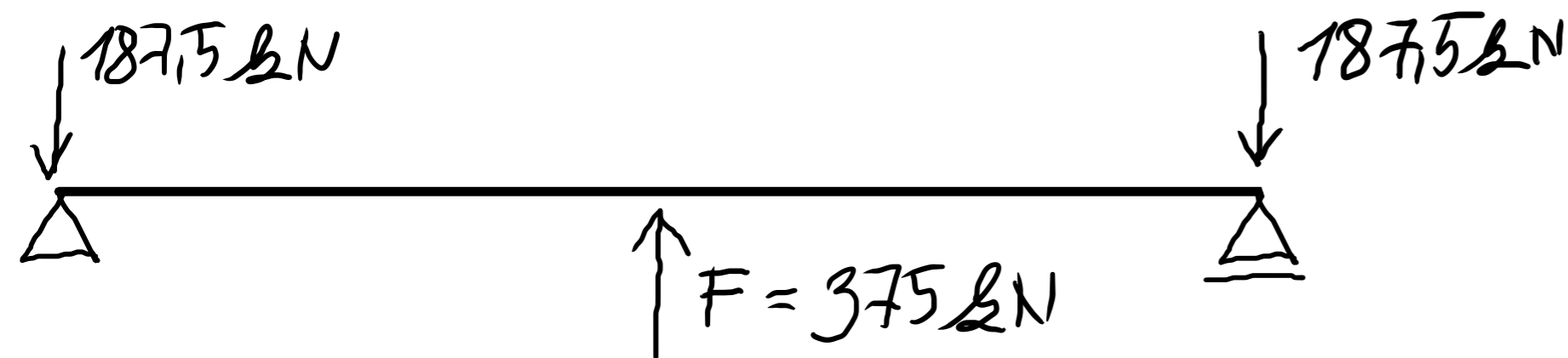

MJS: $w = \frac{Fl^3}{48EI} \rightarrow F = \frac{48EIw}{l^3}$

$$F = \frac{48 \cdot 30 \cdot 10^9 \cdot 1,3 \cdot 10^{-4}}{8^3} = 375\,000 \text{ N} = 375 \text{ kN}$$

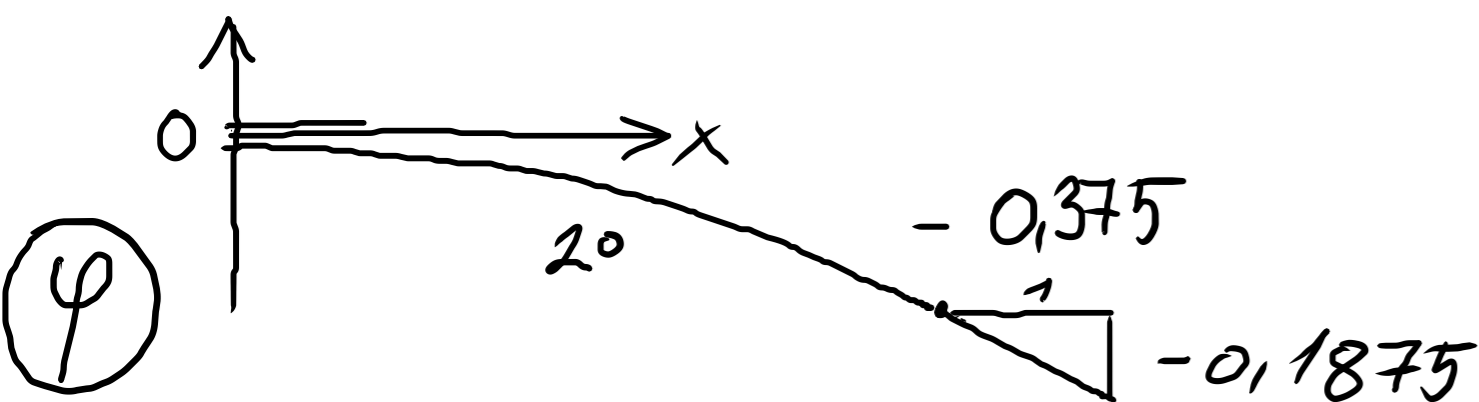
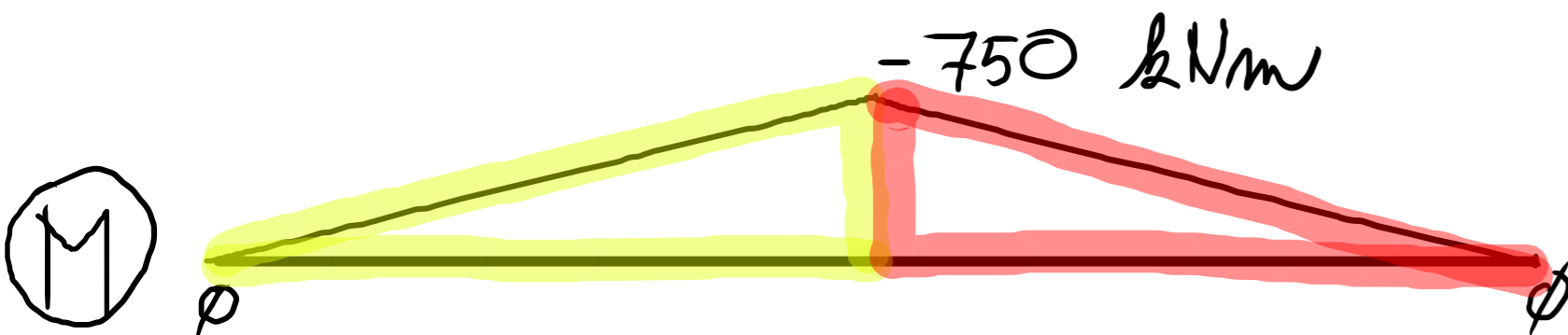
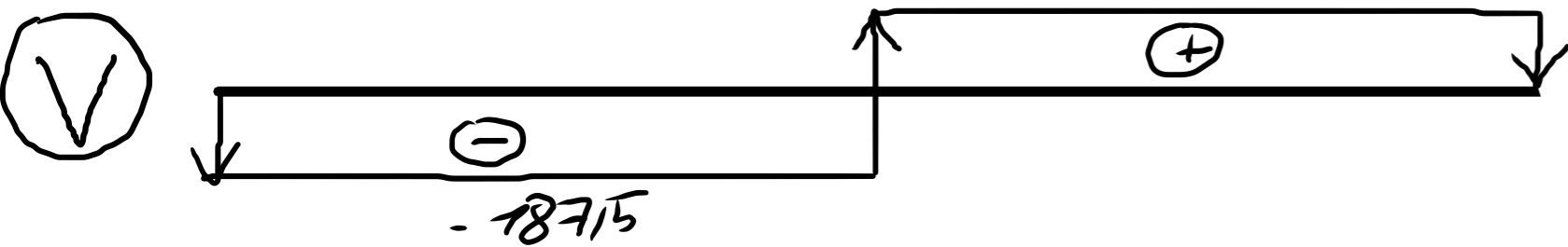

$$1) \varphi = \int_0^8 \frac{M}{EI} dx = \frac{1}{EI} \left(\int_0^4 M dx + \int_4^8 M dx \right)$$

2) C

PŘÍČINKOVÉ ČÁRY - S. N. - VYČÍSLENÍ

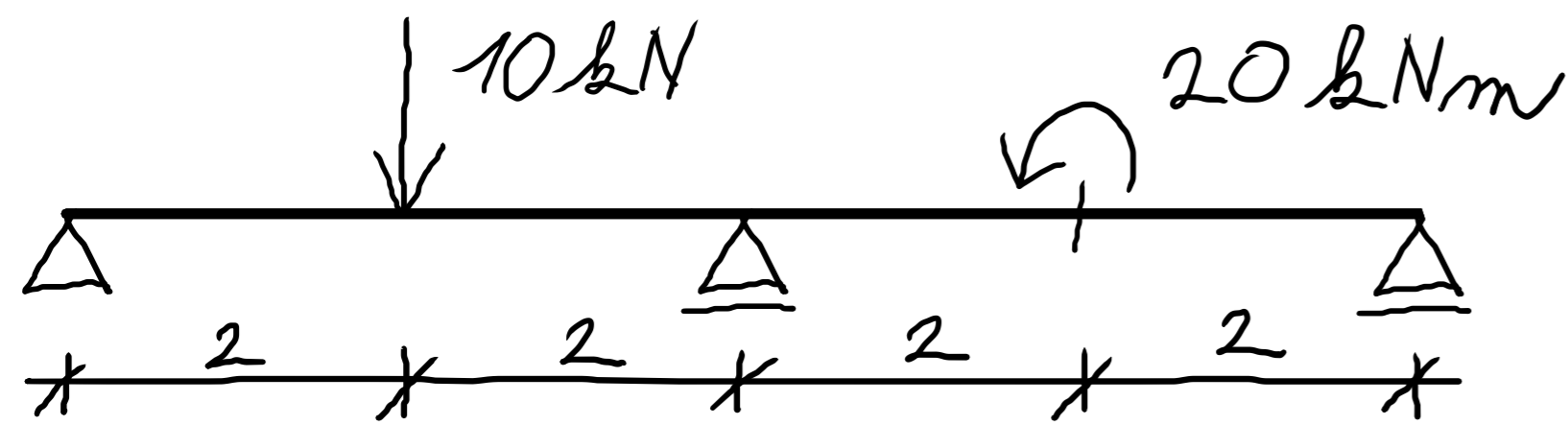

 0,2
 0,2 [m]
 $E = 30 \text{ GPa}$

VYČÍSLETE PROSTŘEDNÍ REAKCI

$$I = \frac{1}{12} \cdot 0,2 \cdot 0,2^3 = 1,3 \cdot 10^{-4} \text{ m}^4$$

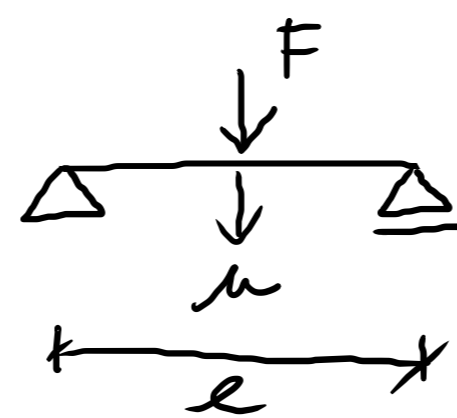
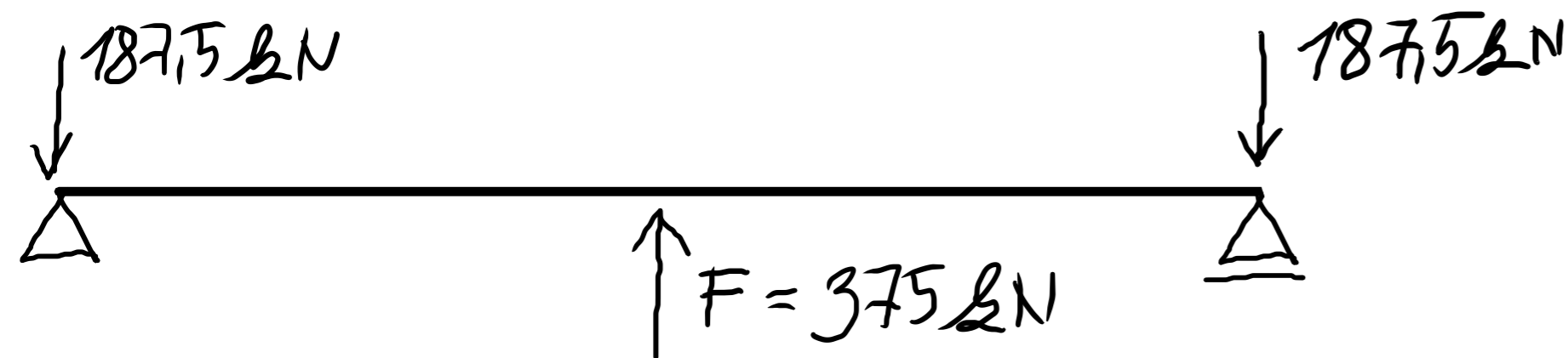

MJS: $w = \frac{Fl^3}{48EI} \rightarrow F = \frac{48EIw}{l^3}$

$$F = \frac{48 \cdot 30 \cdot 10^9 \cdot 1,3 \cdot 10^{-4}}{8^3} = 375\,000 \text{ N} = 375 \text{ kN}$$

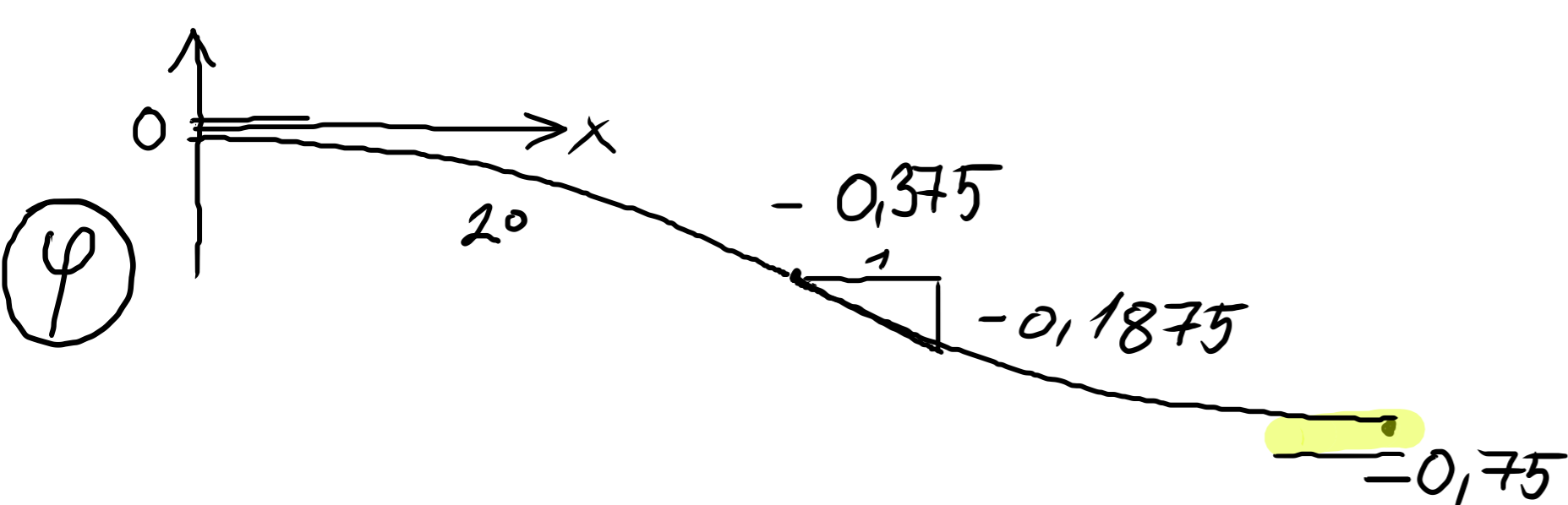
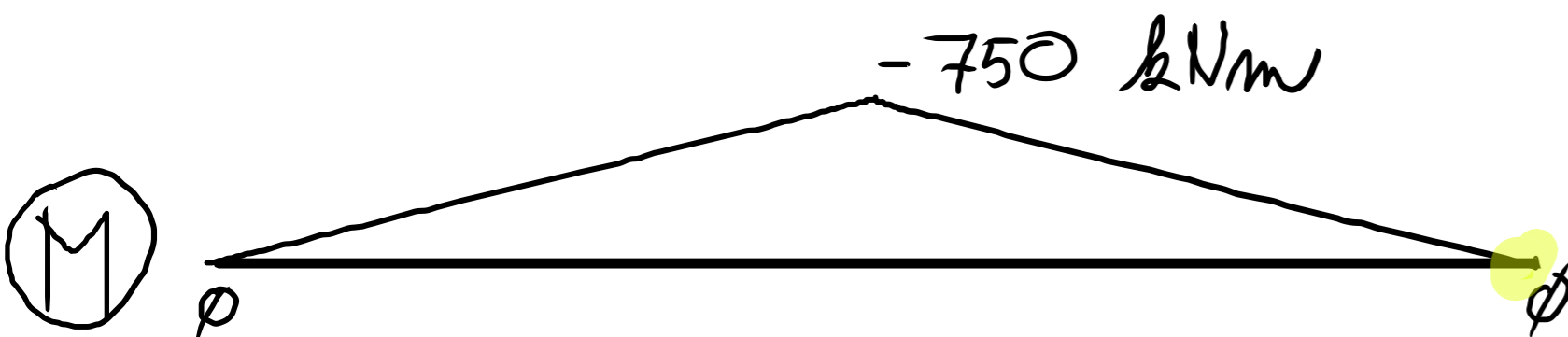
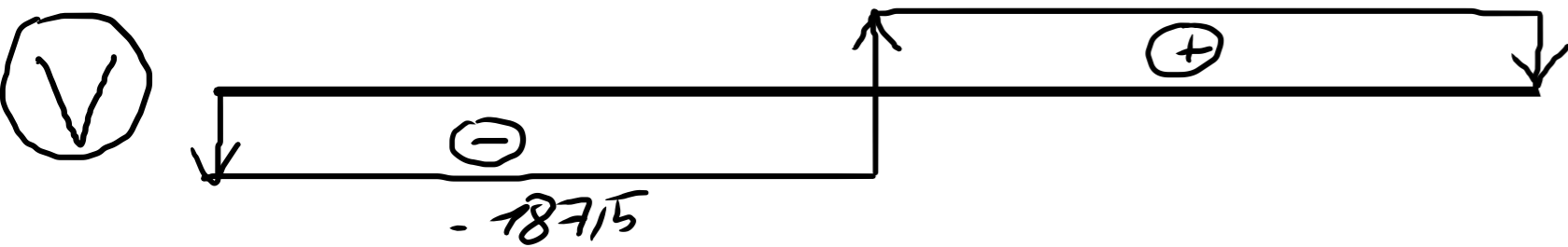

$$1) \varphi = \int_0^8 \frac{M}{EI} dx = \frac{1}{EI} \left(\int_0^4 M dx + \int_4^8 M dx \right)$$

2) C

PŘÍČINKOVÉ ČÁRY - S. N. - VYČÍSLENÍ

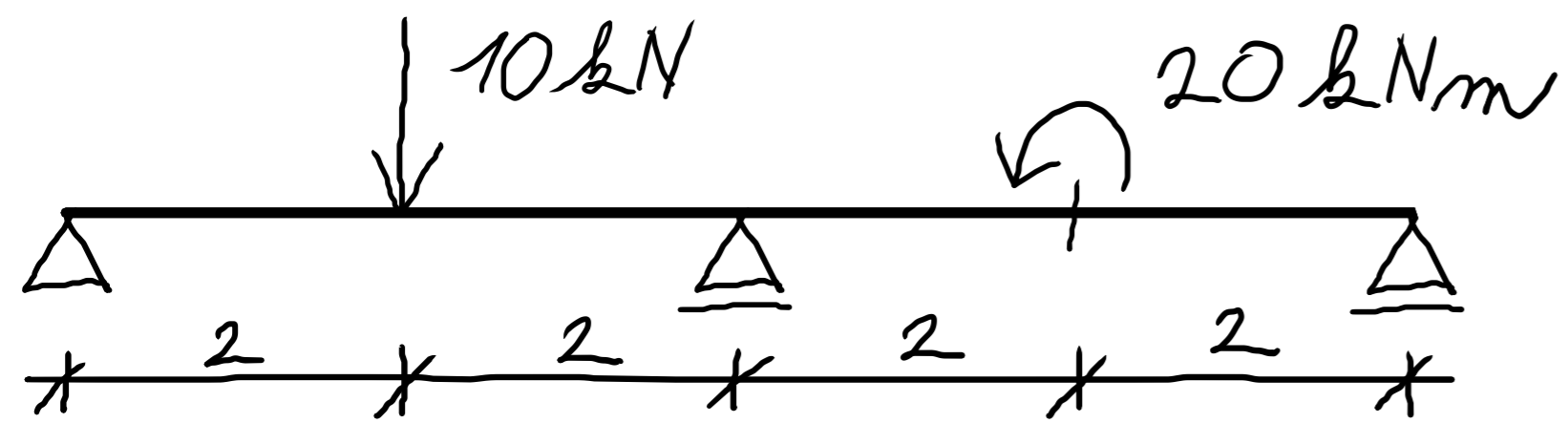

$0,2$ [m]
 $E = 30 \text{ GPa}$

VYČÍSLETE PROSTŘEDNÍ REAKCI

$$I = \frac{1}{12} \cdot 0,2 \cdot 0,2^3 = 1,3 \cdot 10^{-4} \text{ m}^4$$

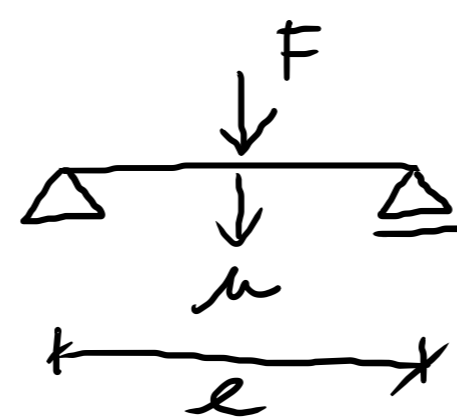
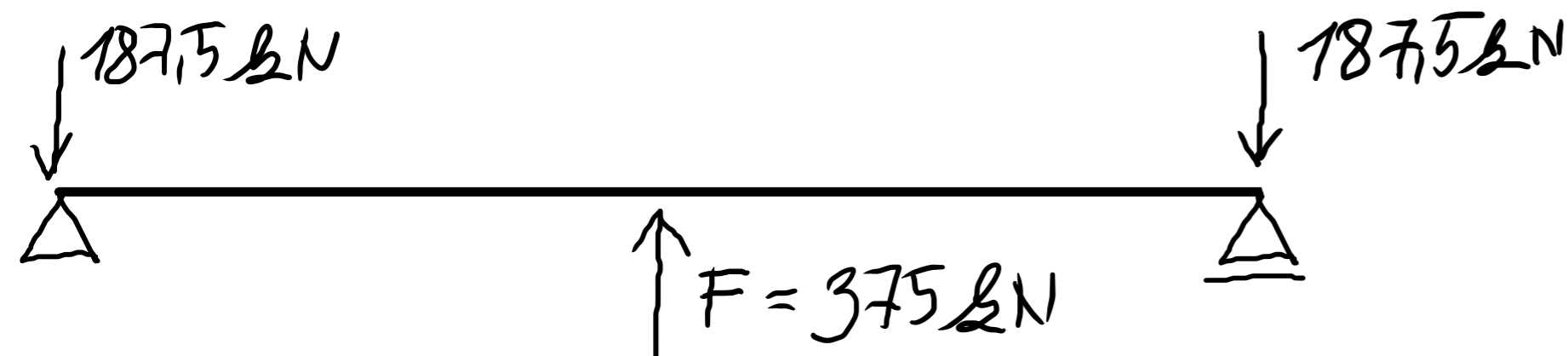

MJS: $w = \frac{Fl^3}{48EI} \rightarrow F = \frac{48EIw}{l^3}$

$$F = \frac{48 \cdot 30 \cdot 10^9 \cdot 1,3 \cdot 10^{-4}}{8^3} = 375\,000 \text{ N} = 375 \text{ kN}$$

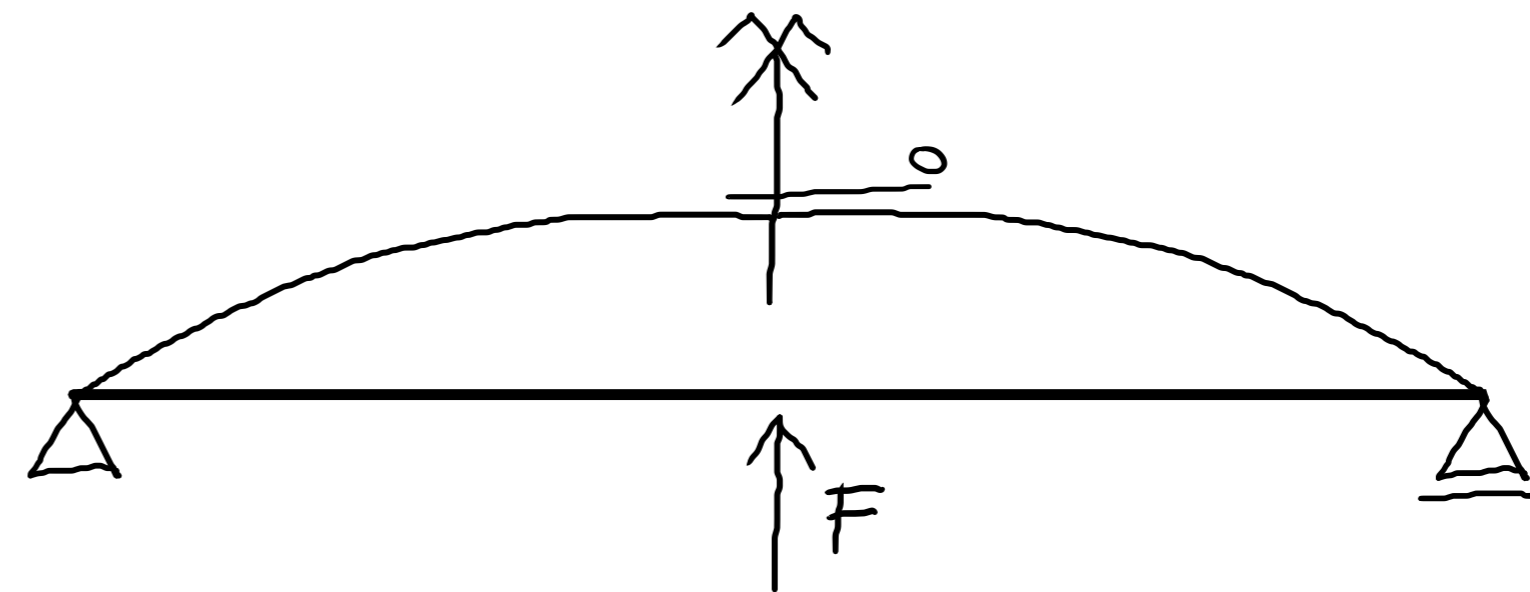
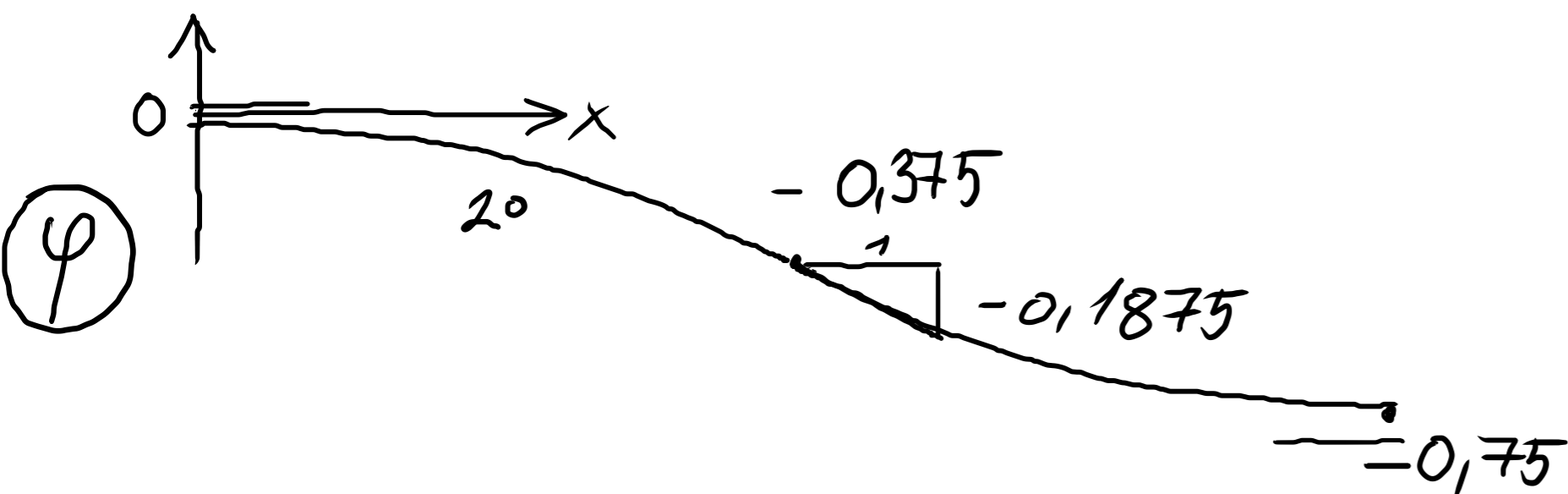
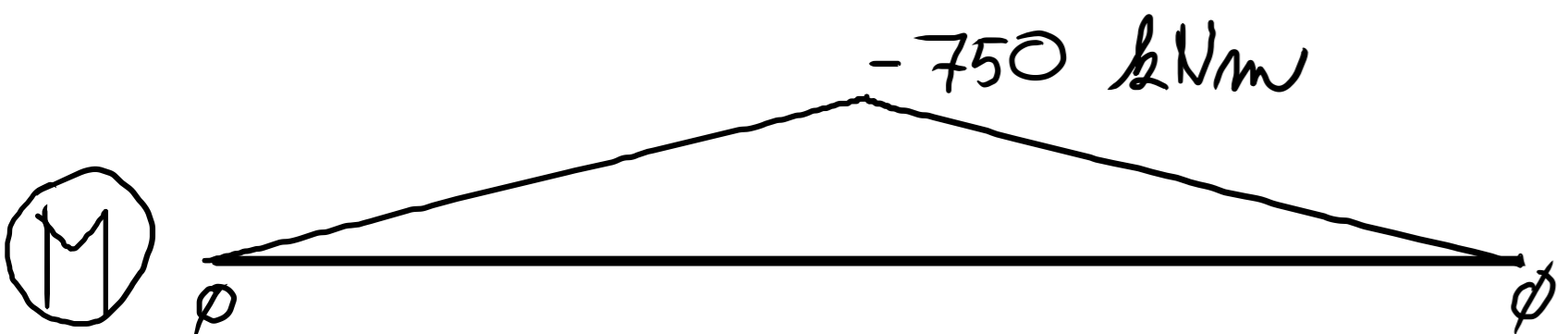
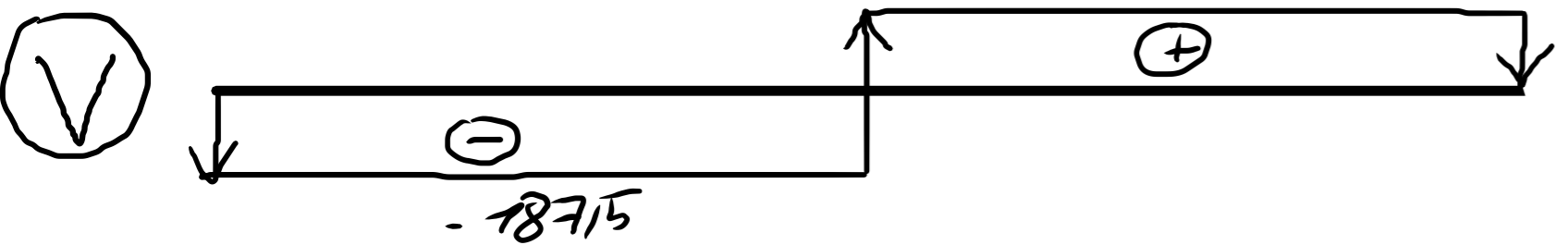

$$1) \varphi = \int_0^8 \frac{M}{EI} dx = \frac{1}{EI} \left(\int_0^4 M dx + \int_4^8 M dx \right)$$

2) **C** SYMETRIE ZADÁNÍ $\rightarrow \varphi(l/2) = 0$

PŘÍČINKOVÉ ČÁRY - S. N. - VYČÍSLENÍ

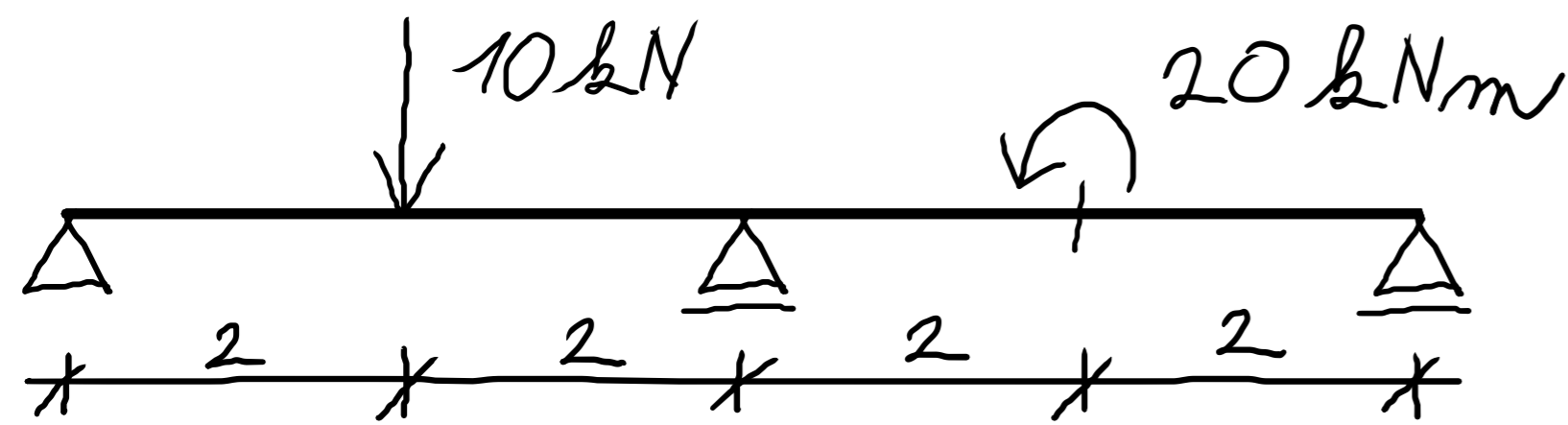

$0,2$
 $0,2 \text{ [m]}$
 $E = 30 \text{ GPa}$

VYČÍSLETE PROSTŘEDNÍ REAKCI

$$I = \frac{1}{12} \cdot 0,2 \cdot 0,2^3 = 1,3 \cdot 10^{-4} \text{ m}^4$$

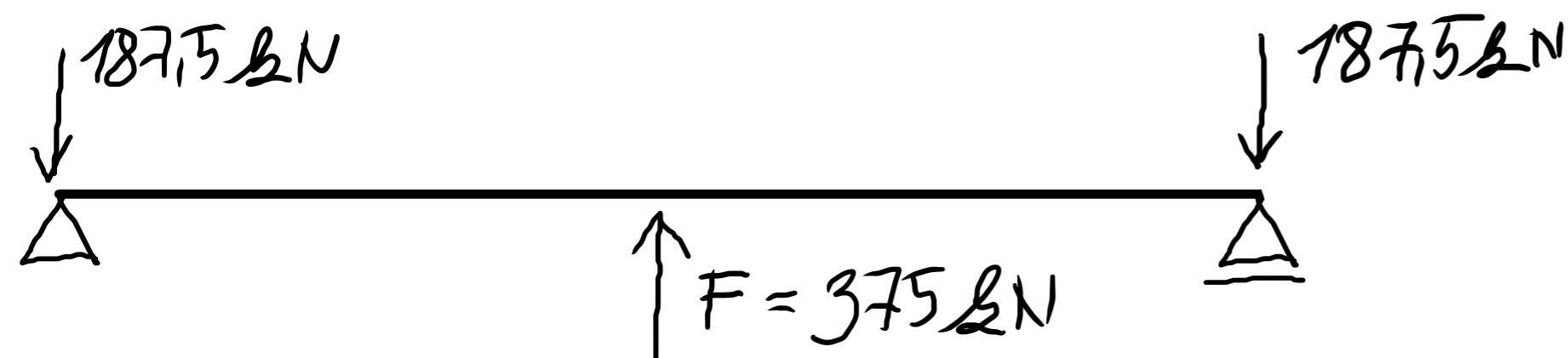

MJS: $w = \frac{Fl^3}{48EI} \rightarrow F = \frac{48EIw}{l^3}$

$$F = \frac{48 \cdot 30 \cdot 10^9 \cdot 1,3 \cdot 10^{-4}}{8^3} = 375\,000 \text{ N} = 375 \text{ kN}$$

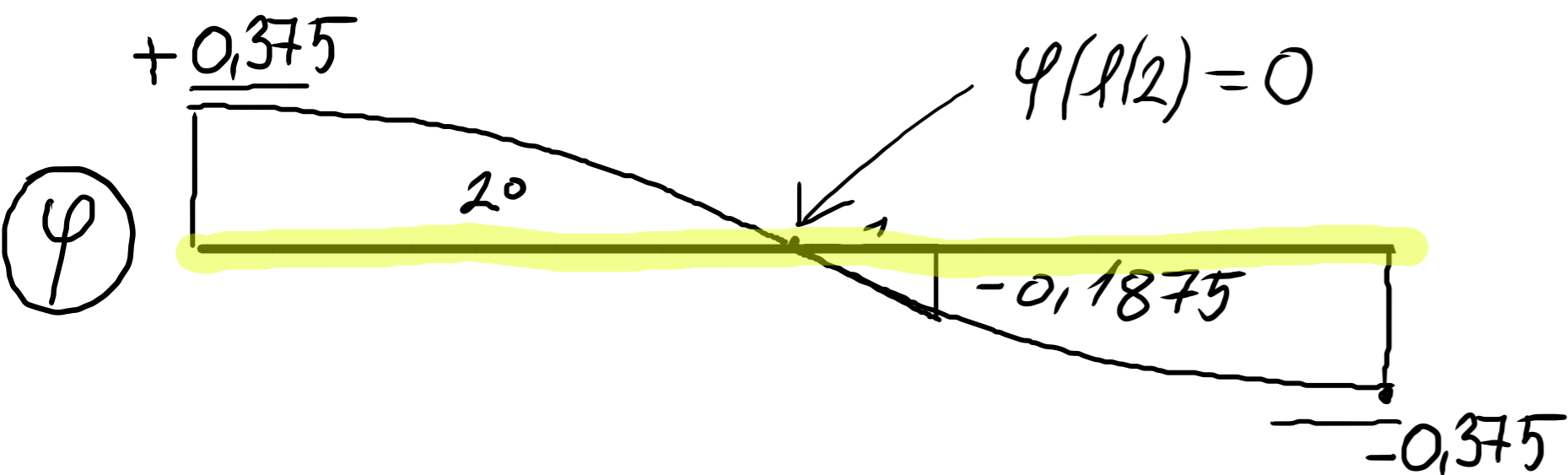
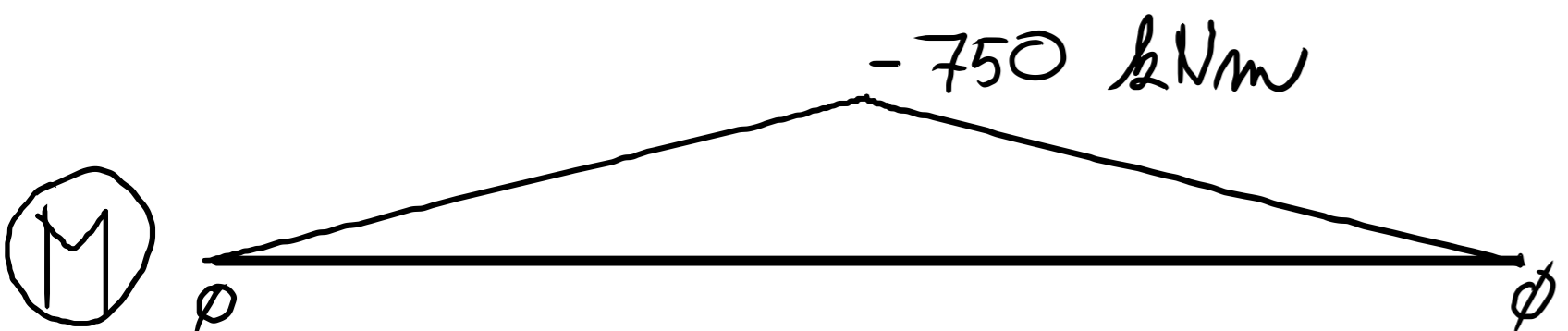
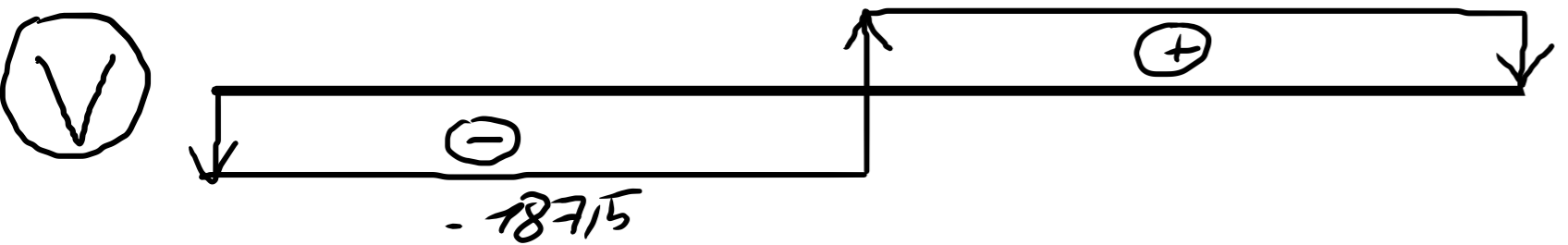

$$1) \varphi = \int_0^8 \frac{M}{EI} dx = \frac{1}{EI} \left(\int_0^4 M dx + \int_4^8 M dx \right)$$

2) \subset SYMETRIE ZADÁNÍ $\rightarrow \varphi(l/2) = 0$

PŘÍČINKOVÉ ČÁRY - S. N. - VYČÍSLENÍ

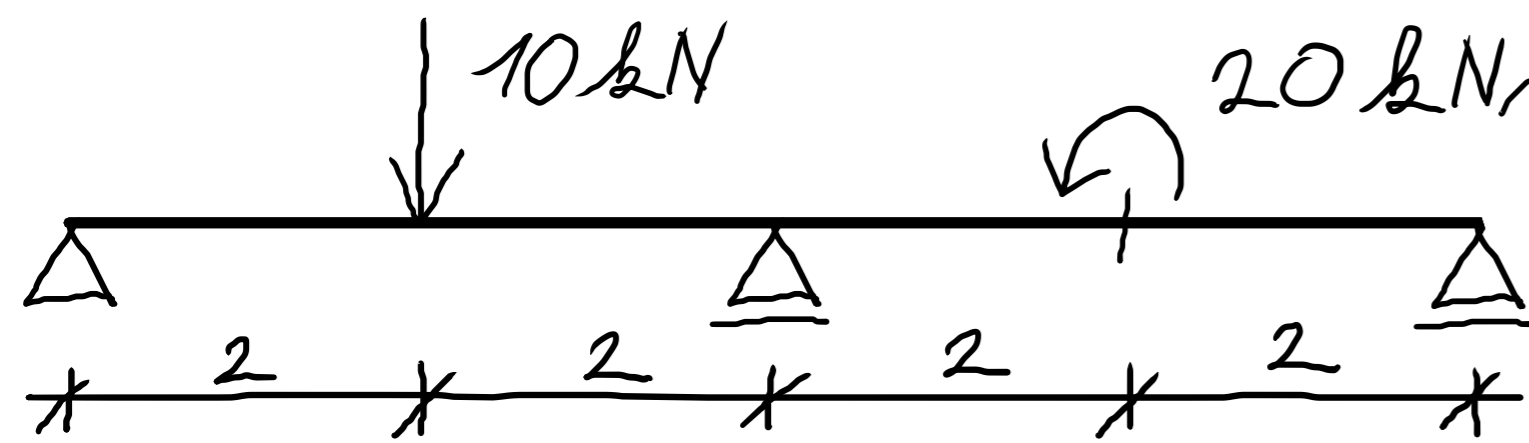

 0,2
 0,2 [m]
 $E = 30 \text{ GPa}$

VYČÍSLETE PROSTŘEDNÍ REAKCI

$$I = \frac{1}{12} \cdot 0,2 \cdot 0,2^3 = 1,3 \cdot 10^{-4} \text{ m}^4$$

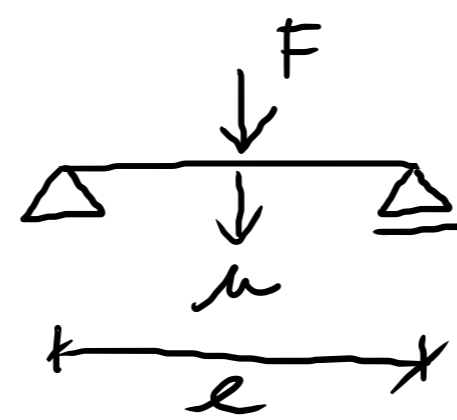
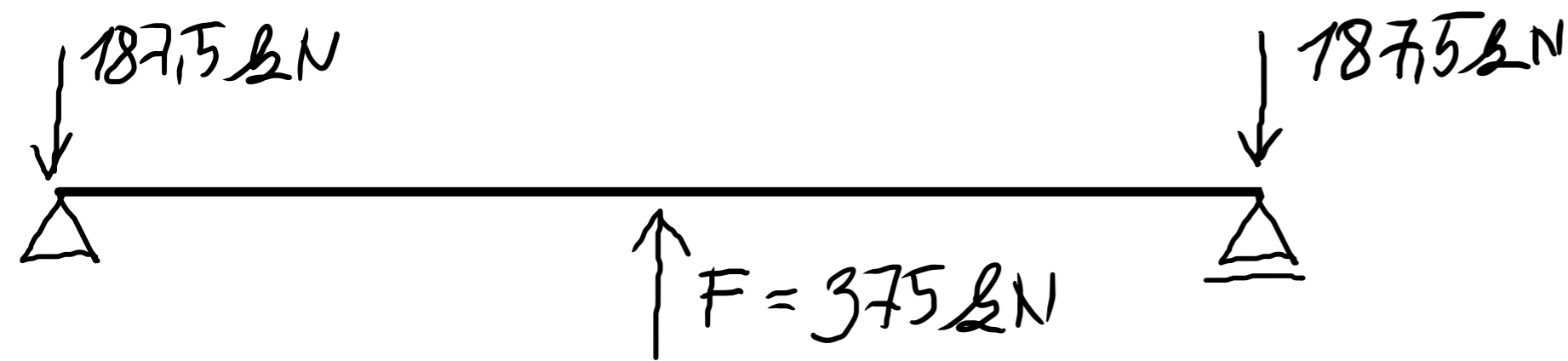

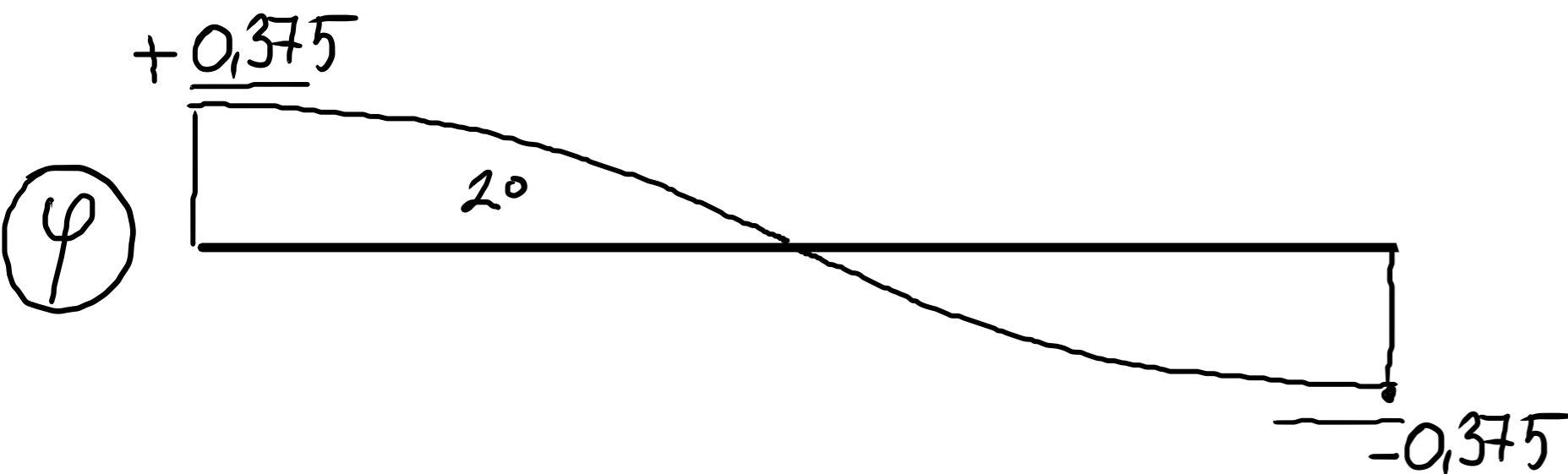
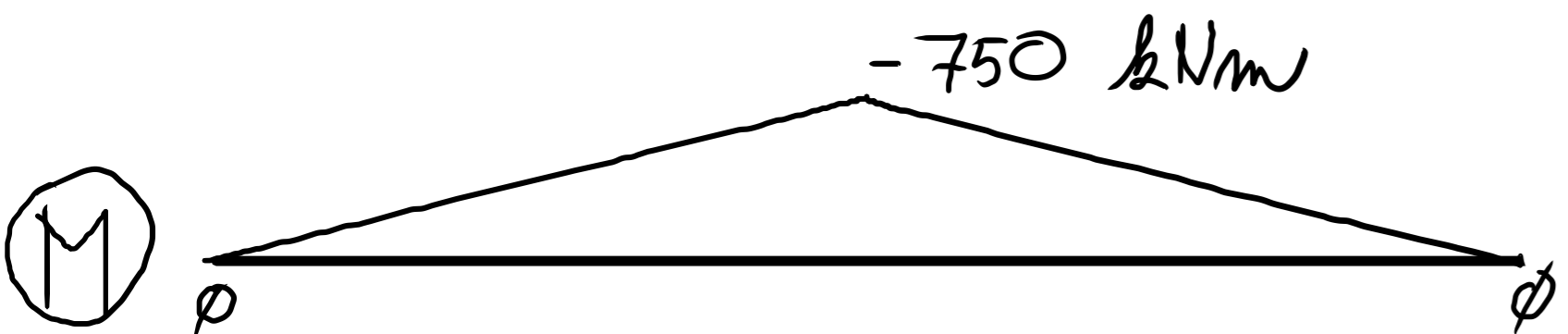
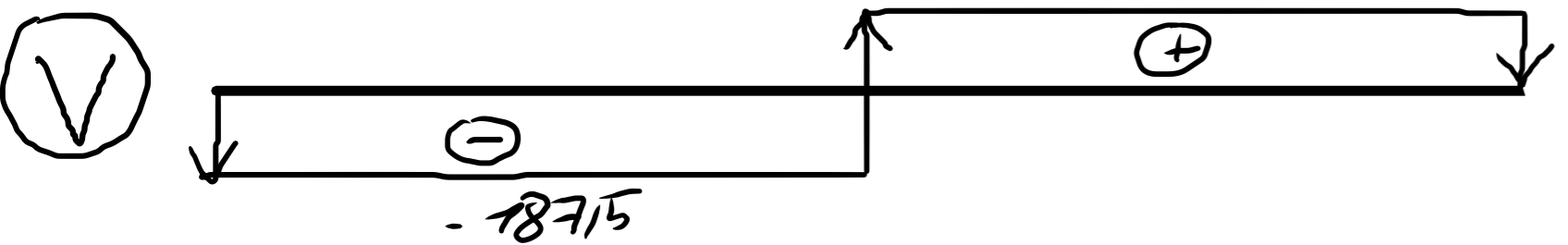

MJS: $w = \frac{Fl^3}{48EI} \rightarrow F = \frac{48EIw}{l^3}$

$$F = \frac{48 \cdot 30 \cdot 10^9 \cdot 1,3 \cdot 10^{-4}}{8^3} = 375\,000 \text{ N} = 375 \text{ kN}$$

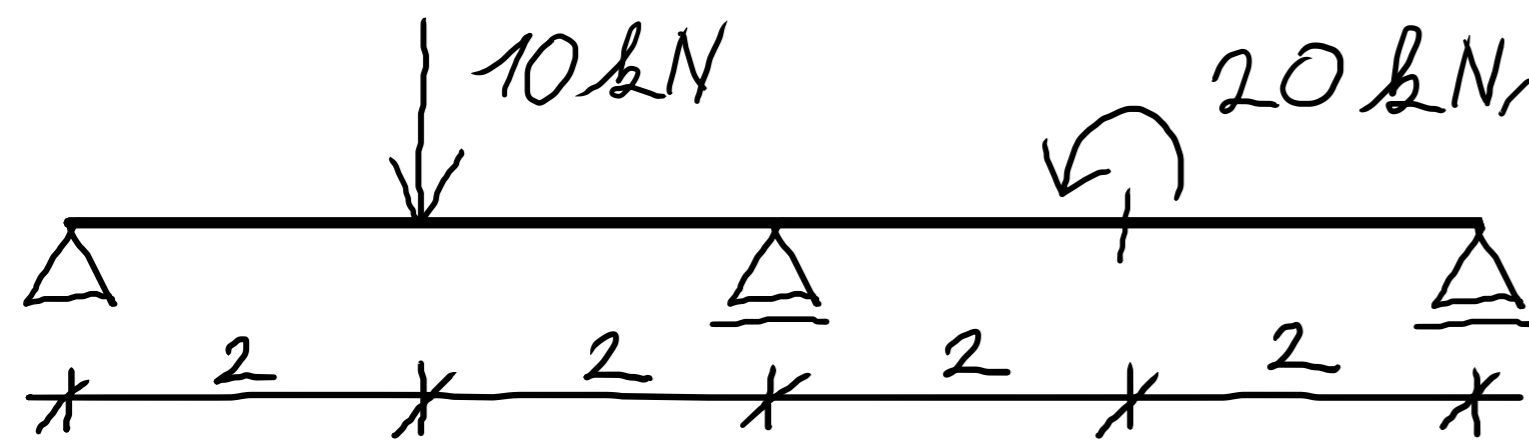

PŘÍČINKOVÉ ČÁRY - S. N. - VYČÍSLENÍ



 0,2
 0,2 [m]
 $E = 30 \text{ GPa}$

VYČÍSLETE PROSTŘEDNÍ REAKCI

$$I = \frac{1}{12} \cdot 0,2 \cdot 0,2^3 = 1,3 \cdot 10^{-4} \text{ m}^4$$

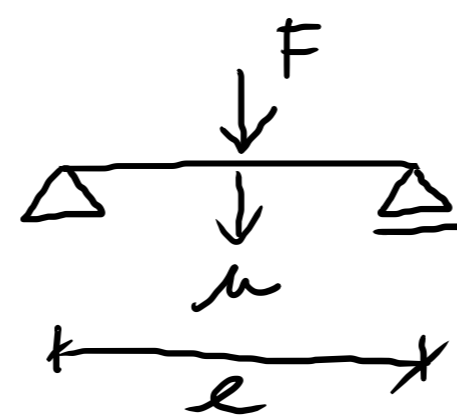
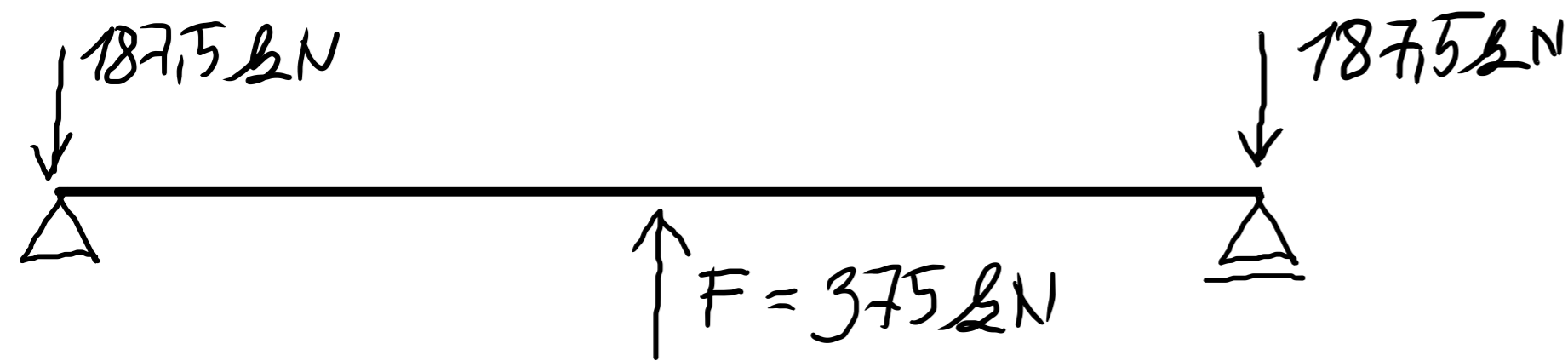

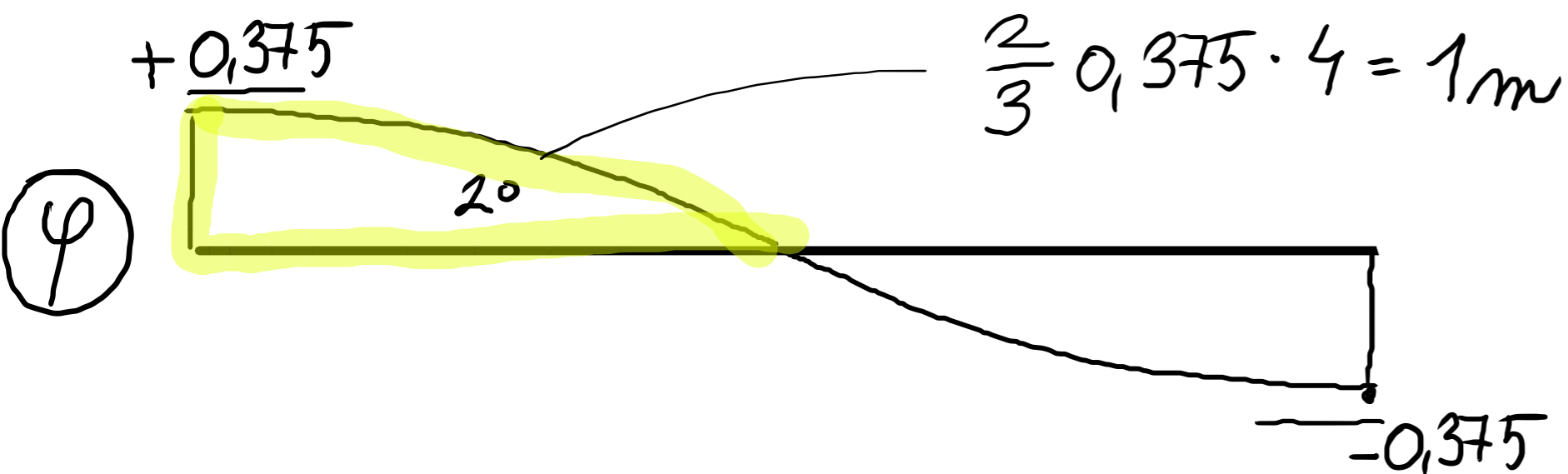
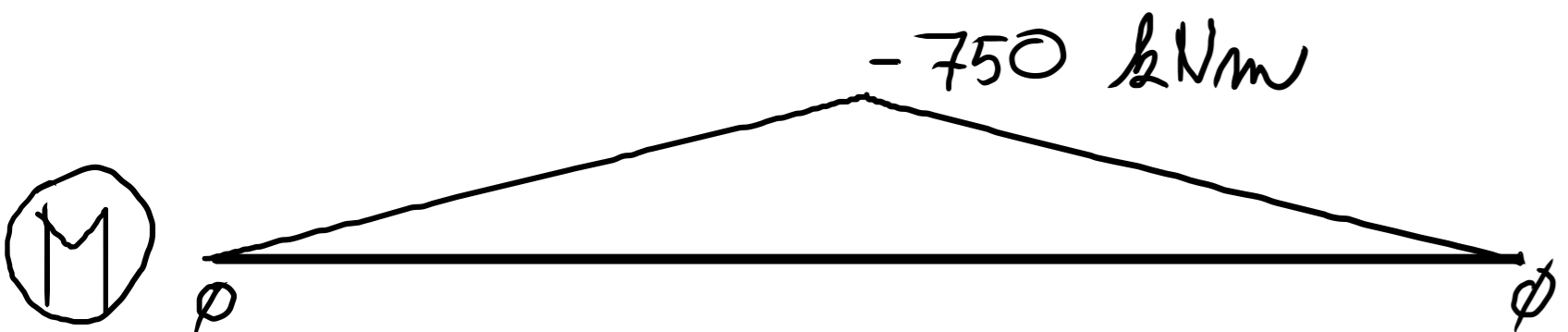
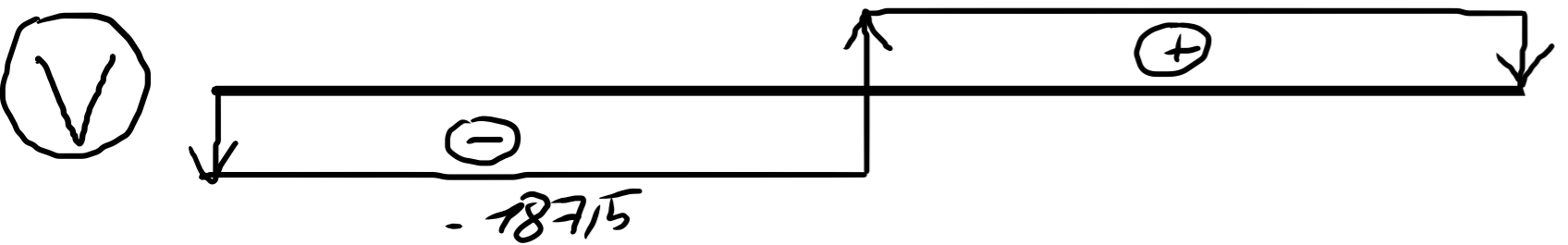

MJS: $w = \frac{Fl^3}{48EI} \rightarrow F = \frac{48EIw}{l^3}$

$$F = \frac{48 \cdot 30 \cdot 10^9 \cdot 1,3 \cdot 10^{-4}}{8^3} = 375\,000 \text{ N} = 375 \text{ kN}$$

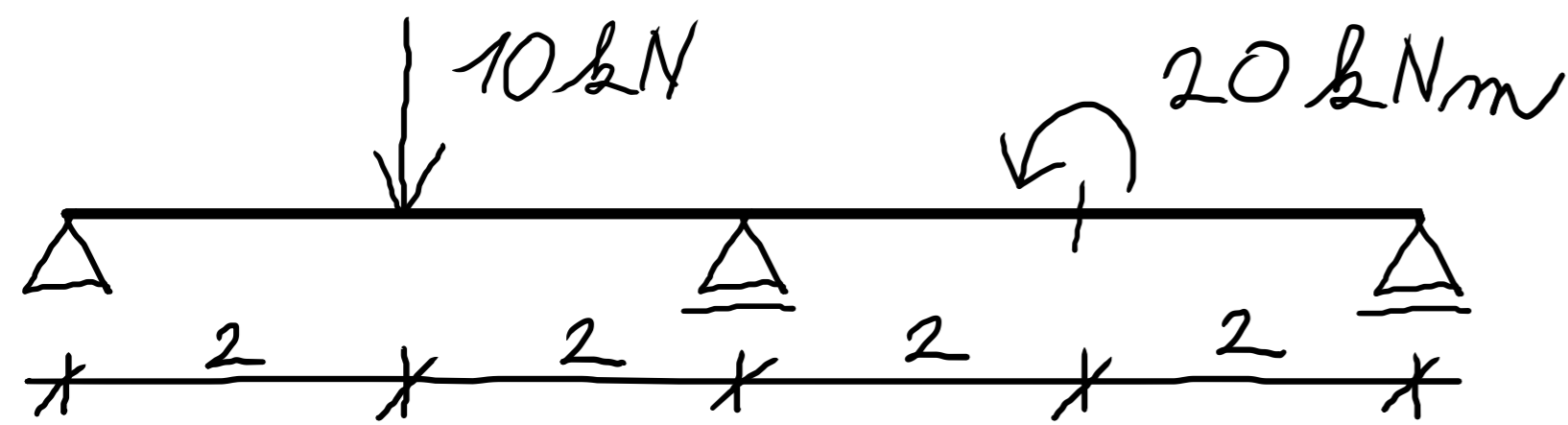

PŘÍČINKOVÉ ČÁRY - S. N. - VYČÍSLENÍ



 0,2
 0,2 [m]
 $E = 30 \text{ GPa}$

VYČÍSLETE PROSTŘEDNÍ REAKCI

$$I = \frac{1}{12} \cdot 0,2 \cdot 0,2^3 = 1,3 \cdot 10^{-4} \text{ m}^4$$

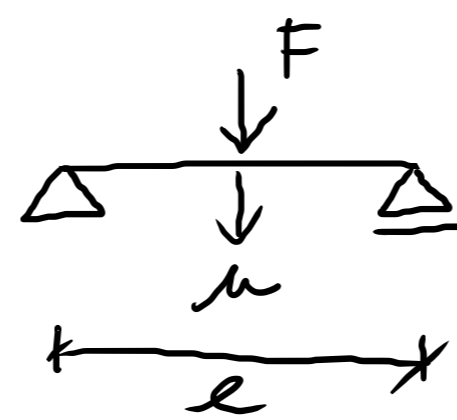
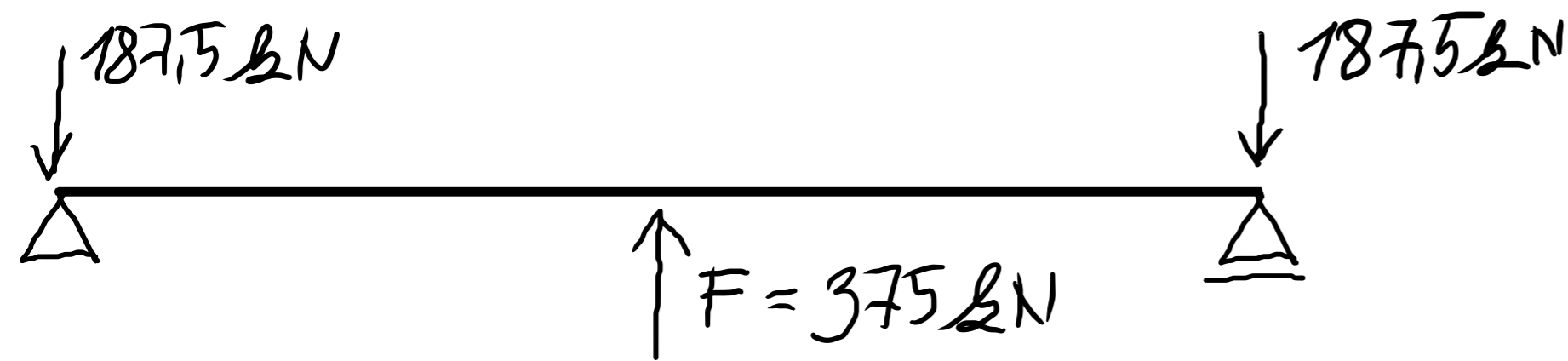

MJS: $w = \frac{Fl^3}{48EI} \rightarrow F = \frac{48EIw}{l^3}$

$$F = \frac{48 \cdot 30 \cdot 10^9 \cdot 1,3 \cdot 10^{-4}}{8^3} = 375\,000 \text{ N} = 375 \text{ kN}$$

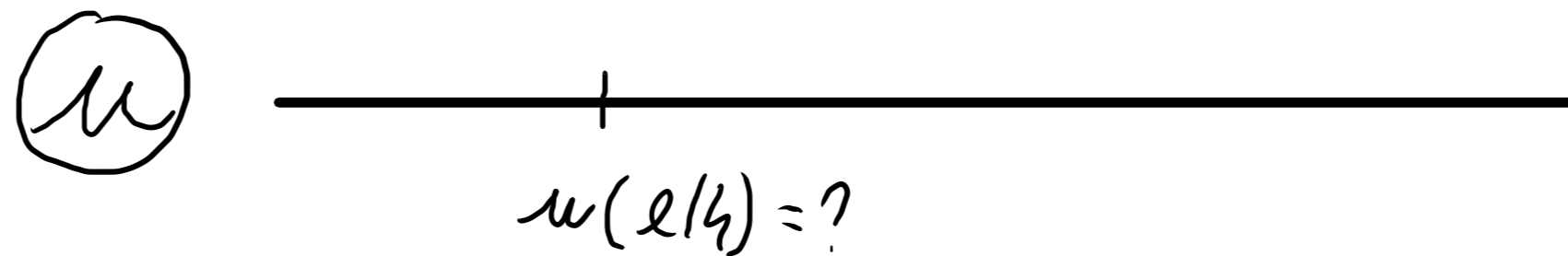
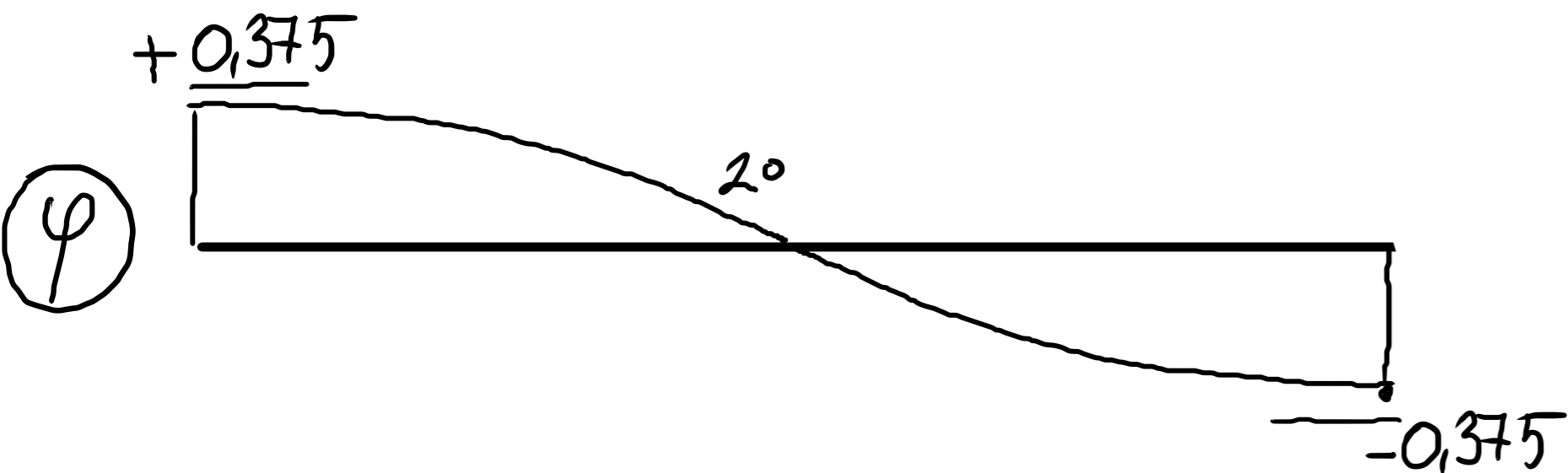
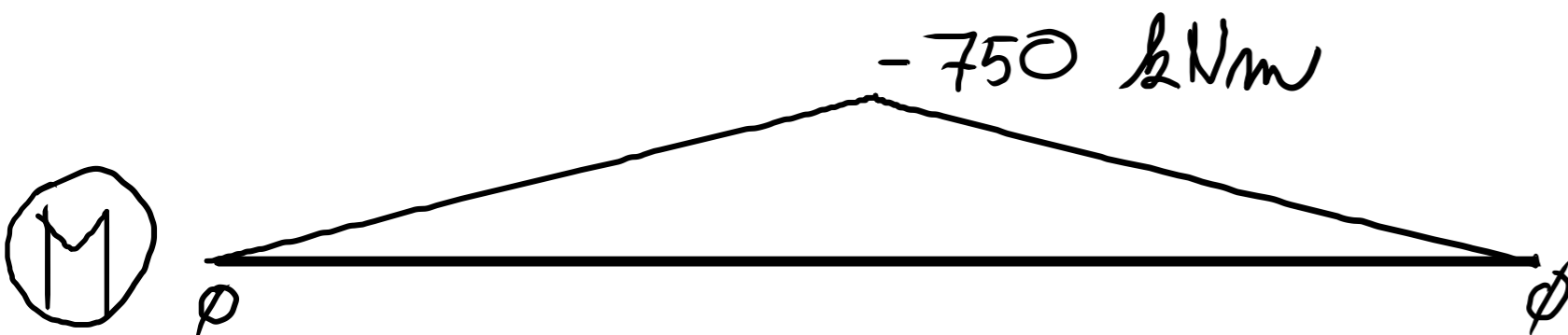
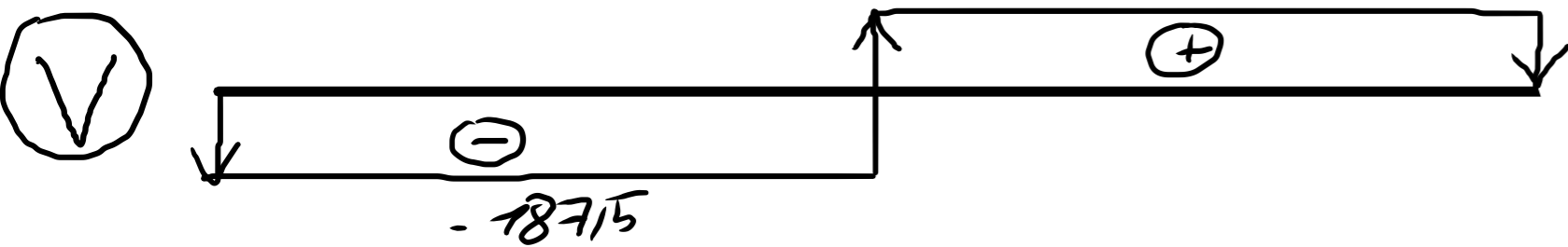

PŘÍČINKOVÉ ČÁRY - S. N. - VYČÍSLENÍ

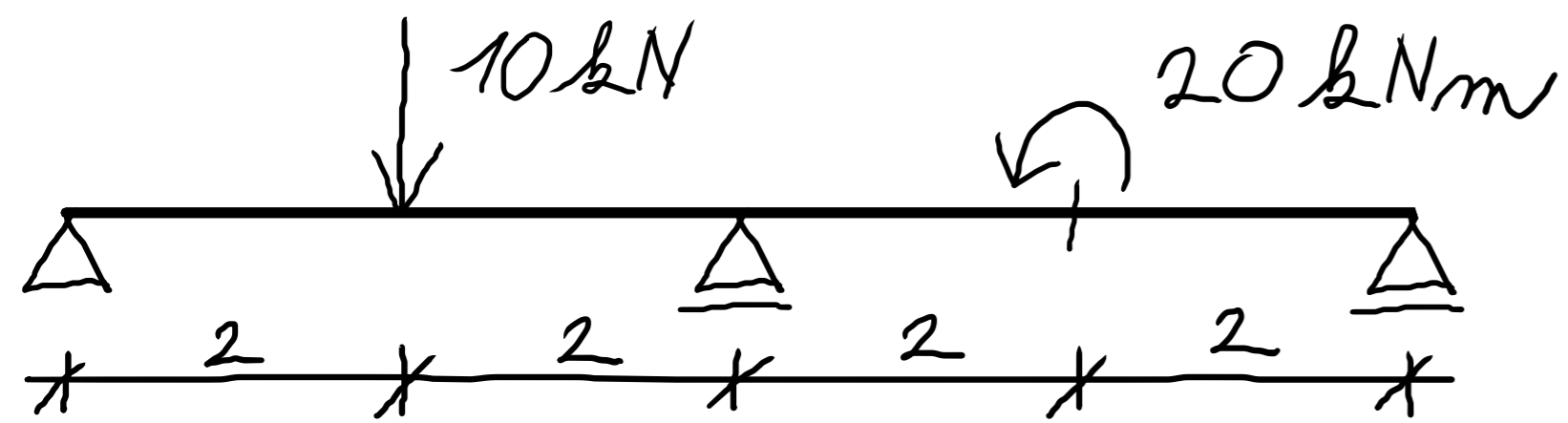

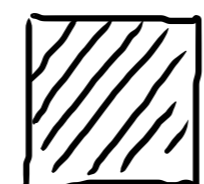
 0,2
 0,2 [m]
 $E = 30 \text{ GPa}$

VYČÍSLETE PROSTŘEDNÍ REAKCI

$$I = \frac{1}{12} \cdot 0,2 \cdot 0,2^3 = 1,3 \cdot 10^{-4} \text{ m}^4$$

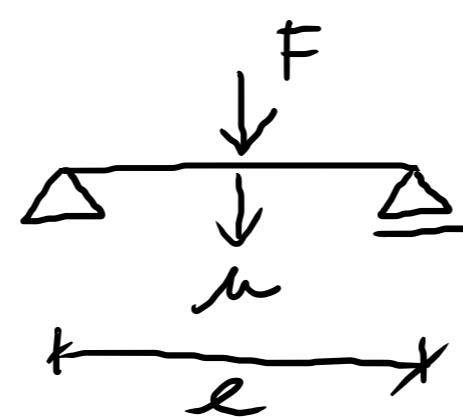
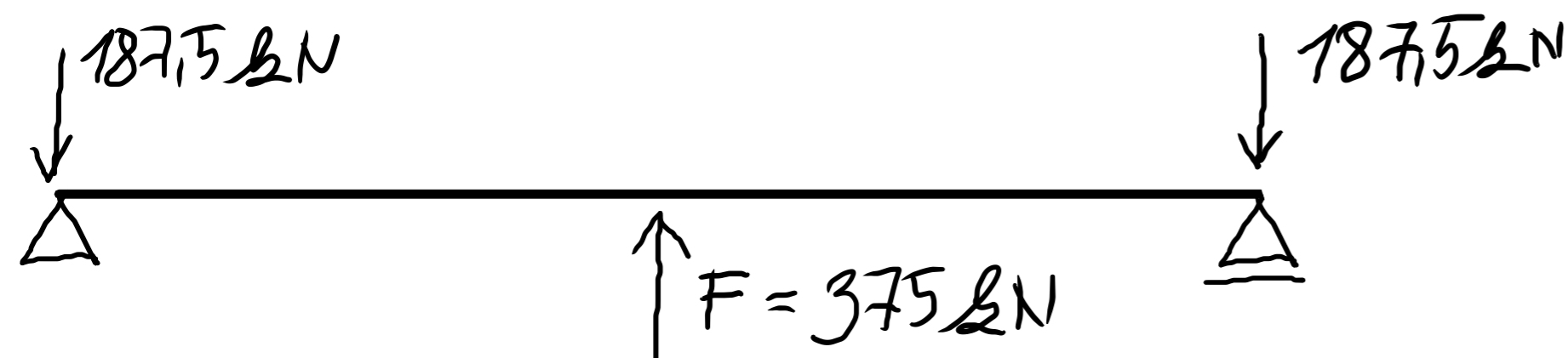

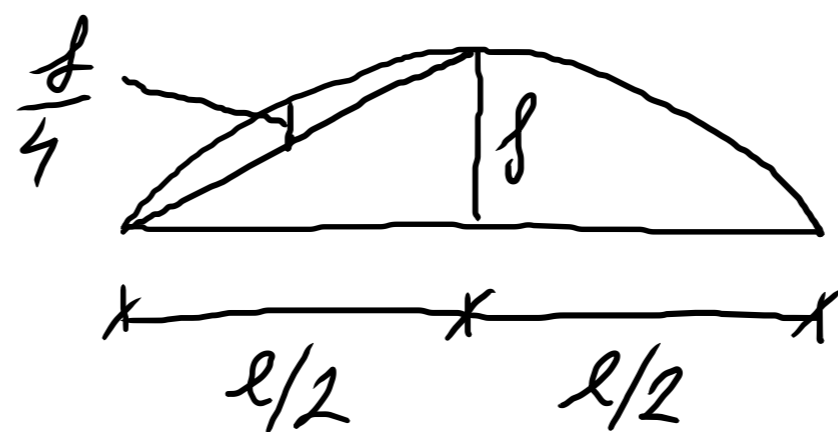
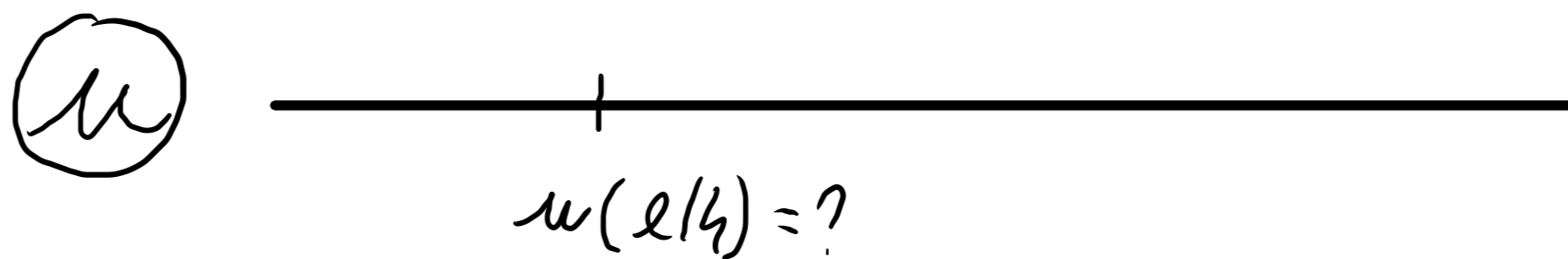
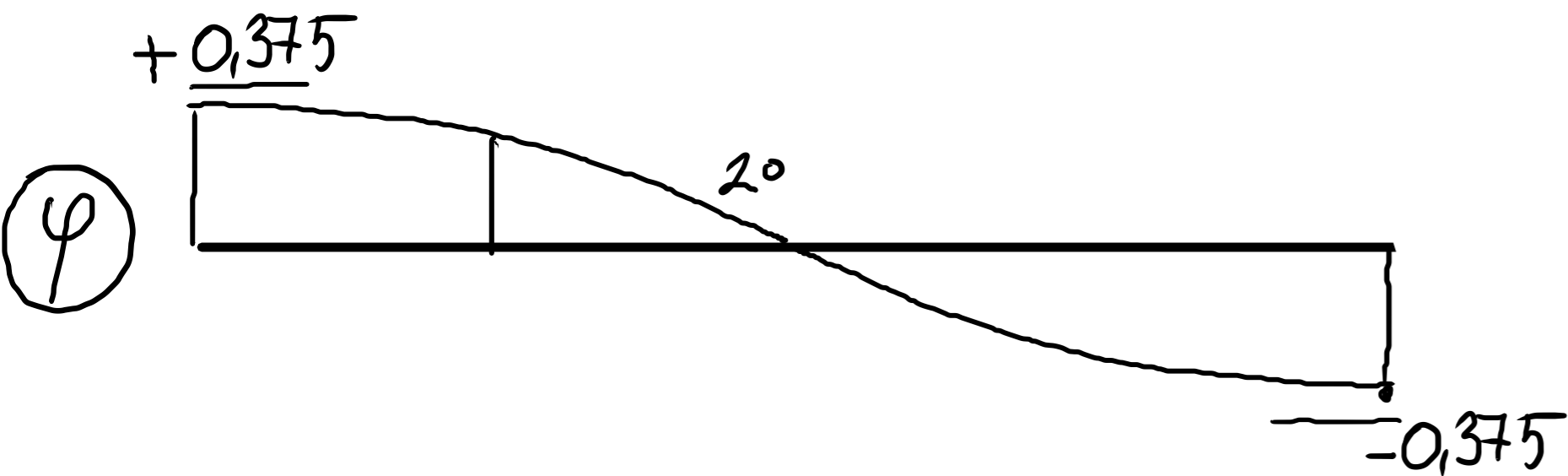
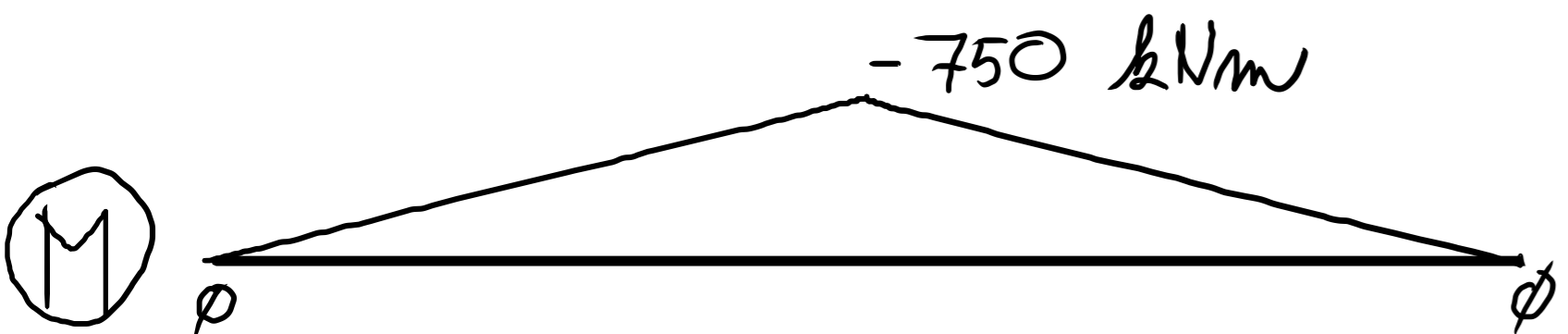
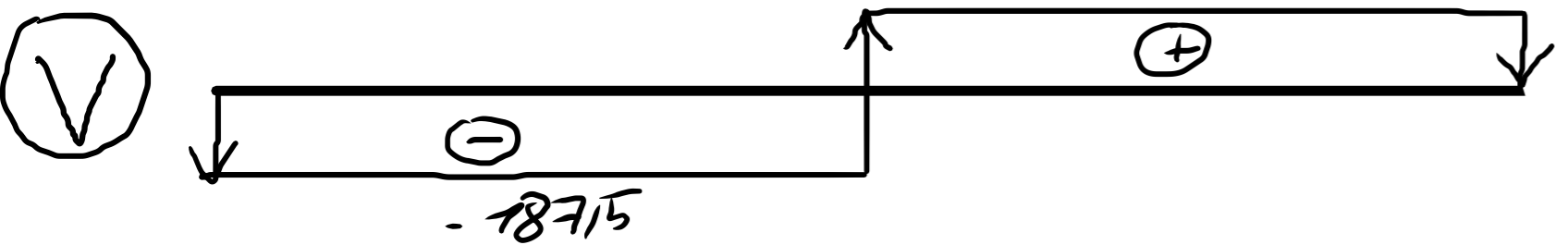

MJS: $w = \frac{Fl^3}{48EI} \rightarrow F = \frac{48EIw}{l^3}$

$$F = \frac{48 \cdot 30 \cdot 10^9 \cdot 1,3 \cdot 10^{-4}}{8^3} = 375\,000 \text{ N} = 375 \text{ kN}$$

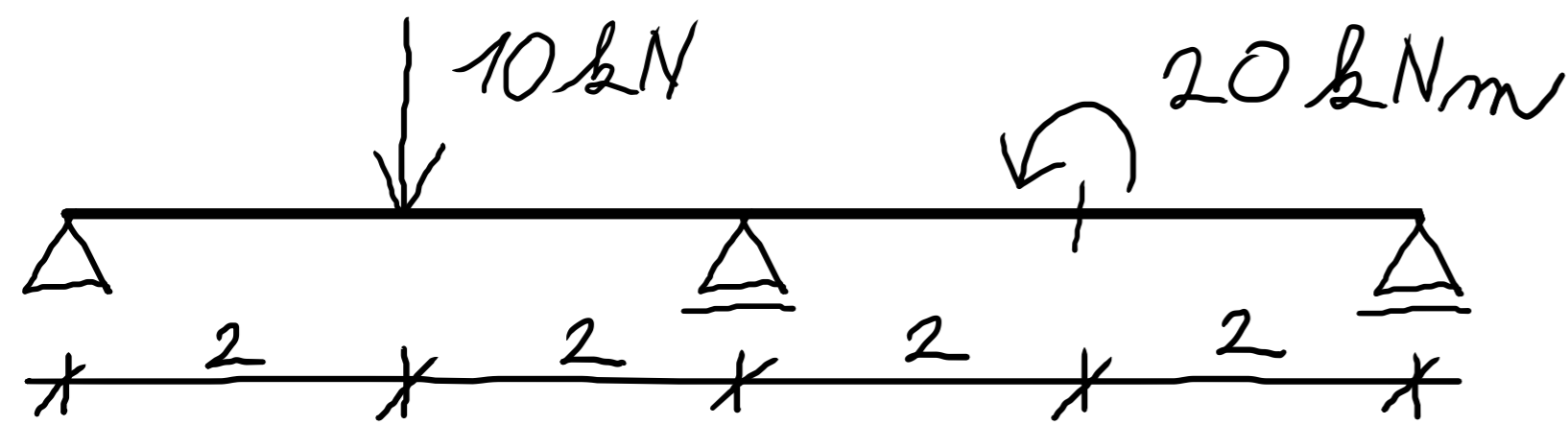

PŘÍČINKOVÉ ČÁRY - S. N. - VYČÍSLENÍ



 0,2
 0,2 [m]
 $E = 30 \text{ GPa}$

VYČÍSLETE PROSTŘEDNÍ REAKCI

$$I = \frac{1}{12} \cdot 0,2 \cdot 0,2^3 = 1,3 \cdot 10^{-4} \text{ m}^4$$

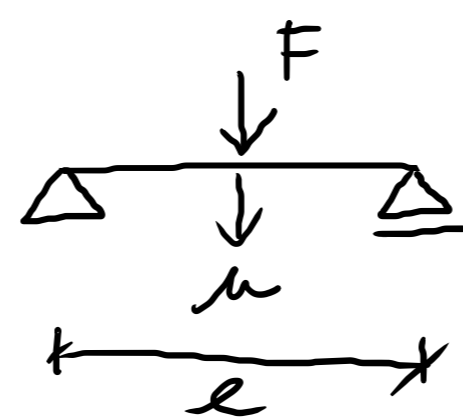
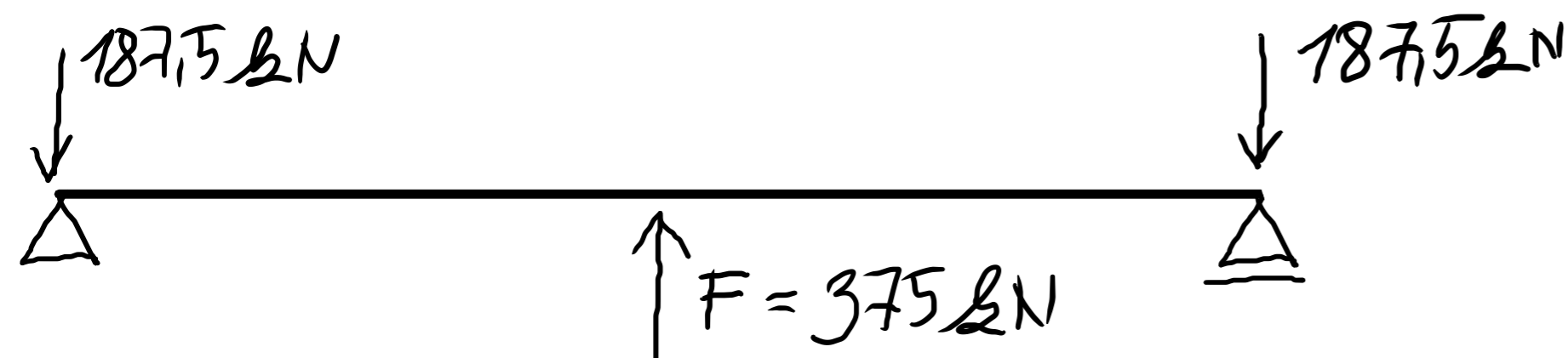

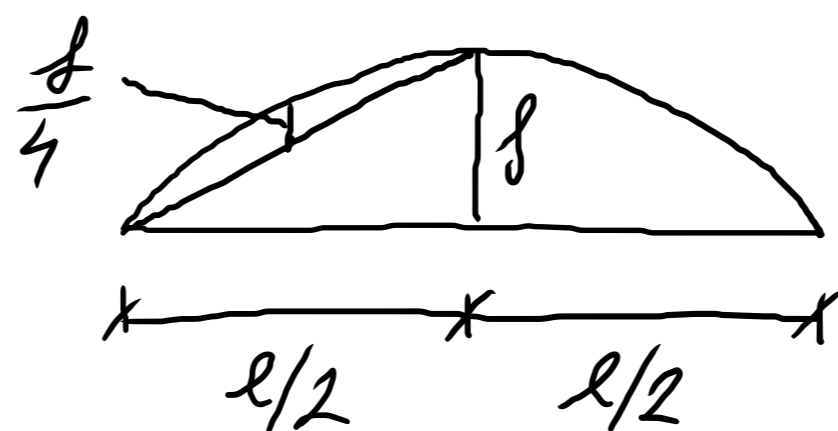
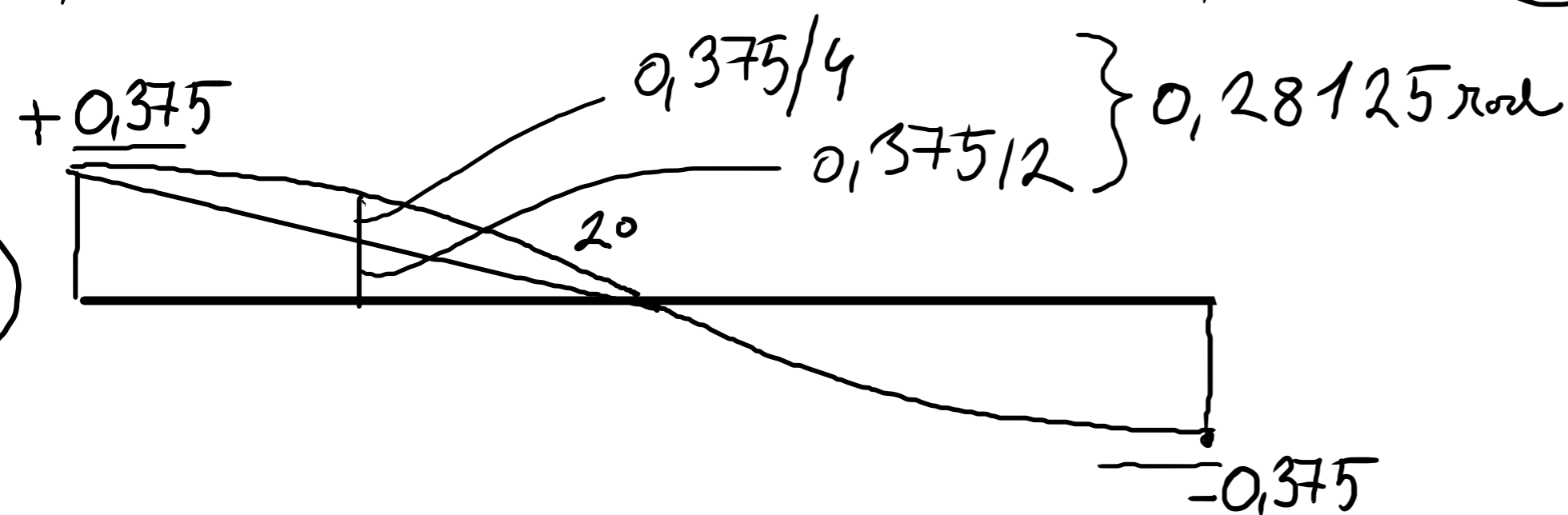
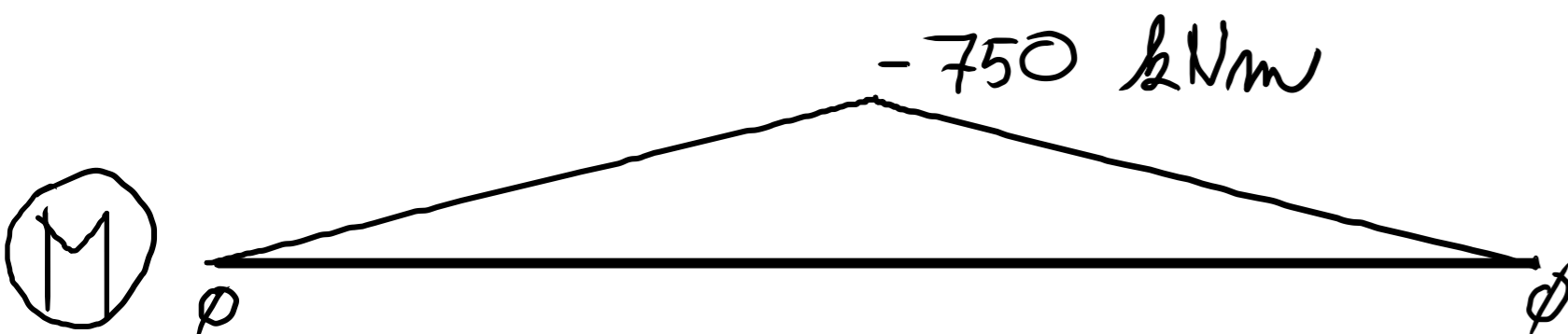
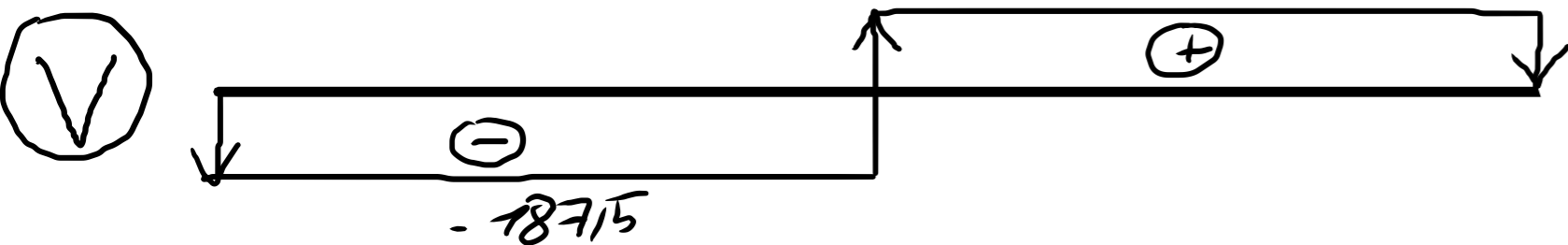

MJS: $w = \frac{Fl^3}{48EI} \rightarrow F = \frac{48EIw}{l^3}$

$$F = \frac{48 \cdot 30 \cdot 10^9 \cdot 1,3 \cdot 10^{-4}}{8^3} = 375\,000 \text{ N} = 375 \text{ kN}$$

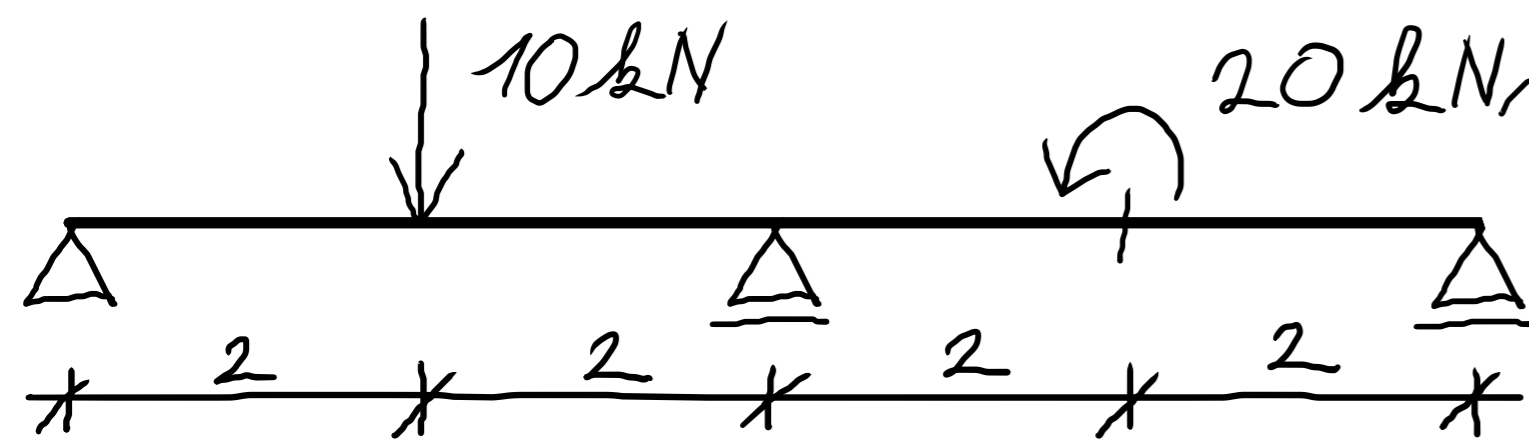

PŘÍČINKOVÉ ČÁRY - S. N. - VYČÍSLENÍ



 0,2
 0,2 [m]
 $E = 30 \text{ GPa}$

VYČÍSLETE PROSTŘEDNÍ REAKCI

$$I = \frac{1}{12} \cdot 0,2 \cdot 0,2^3 = 1,3 \cdot 10^{-4} \text{ m}^4$$

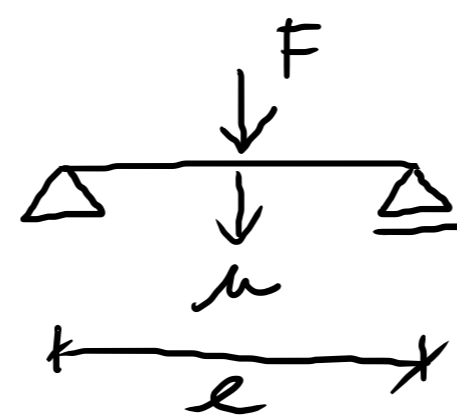
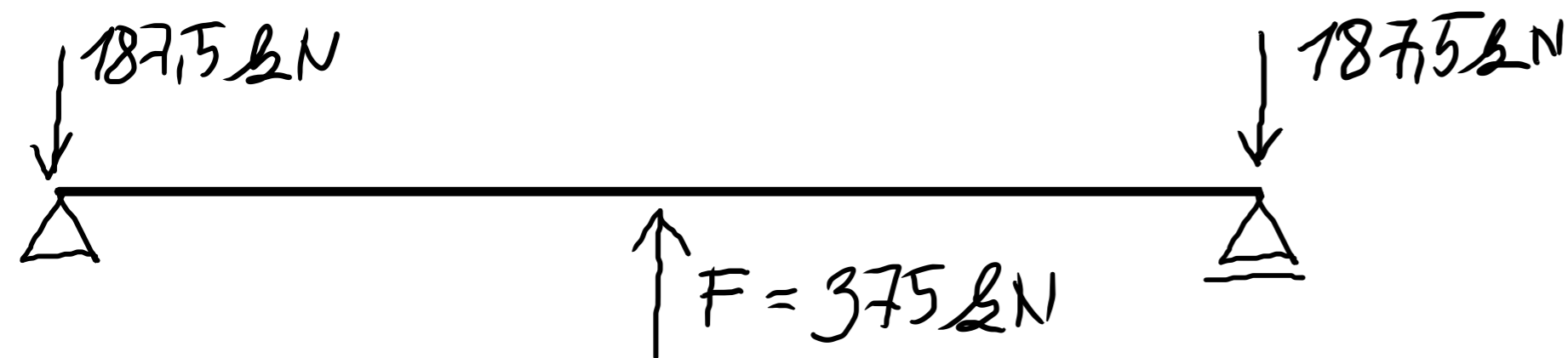

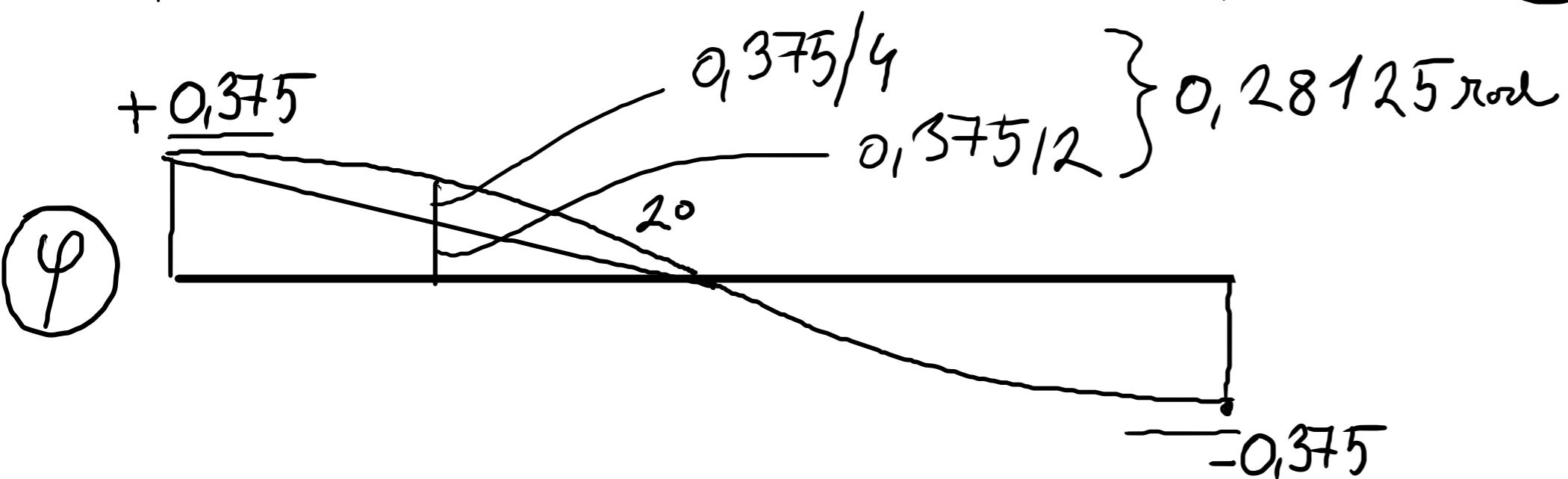
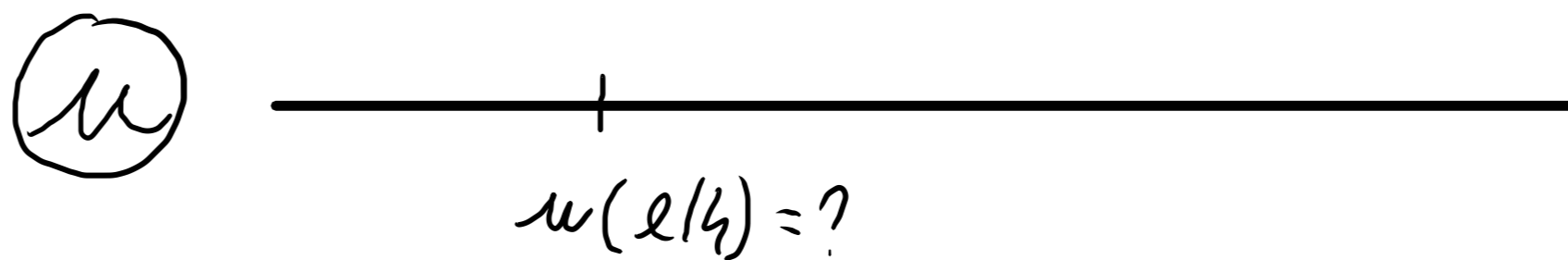
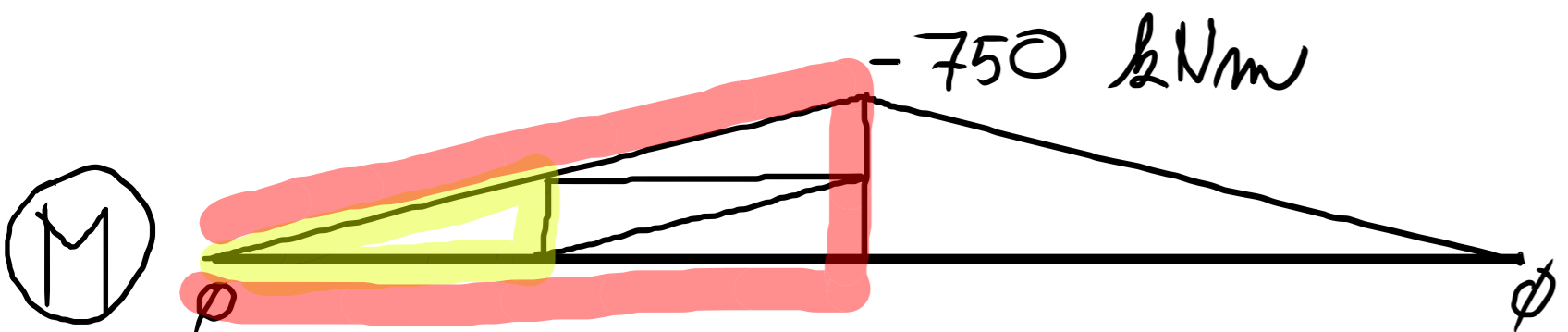
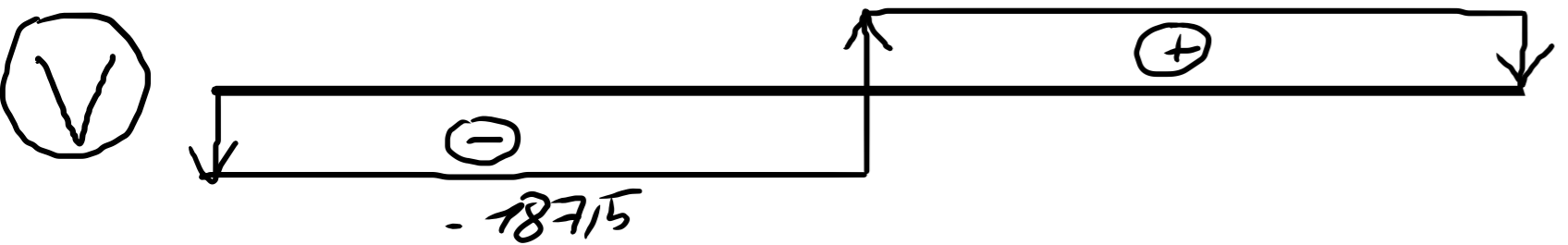

MJS: $w = \frac{Fl^3}{48EI} \rightarrow F = \frac{48EIw}{l^3}$

$$F = \frac{48 \cdot 30 \cdot 10^9 \cdot 1,3 \cdot 10^{-4}}{8^3} = 375\,000 \text{ N} = 375 \text{ kN}$$

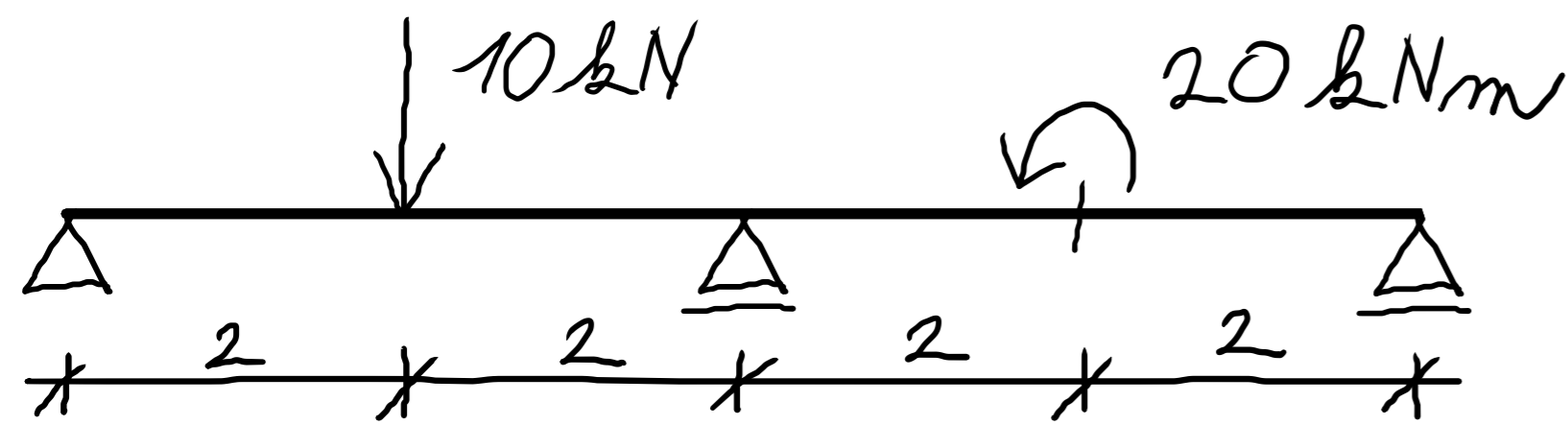

PŘÍČINKOVÉ ČÁRY - S. N. - VYČÍSLENÍ



 0,2
 0,2 [m]
 $E = 30 \text{ GPa}$

VYČÍSLETE PROSTŘEDNÍ REAKCI

$$I = \frac{1}{12} \cdot 0,2 \cdot 0,2^3 = 1,3 \cdot 10^{-4} \text{ m}^4$$

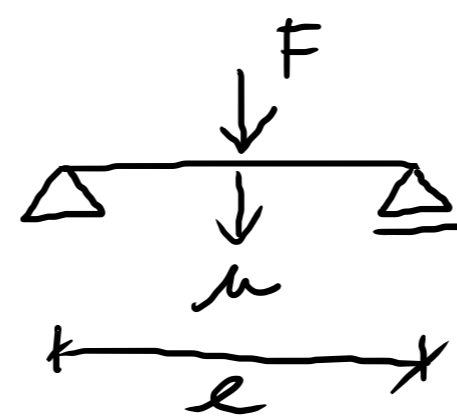
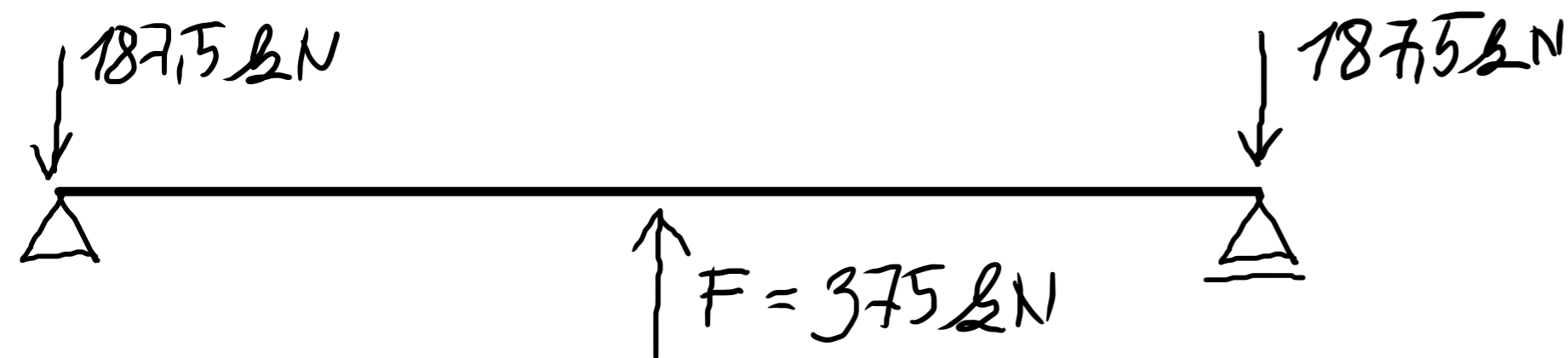

MJS: $w = \frac{Fl^3}{48EI} \rightarrow F = \frac{48EIw}{l^3}$

$$F = \frac{48 \cdot 30 \cdot 10^9 \cdot 1,3 \cdot 10^{-4}}{8^3} = 375\,000 \text{ N} = 375 \text{ kN}$$

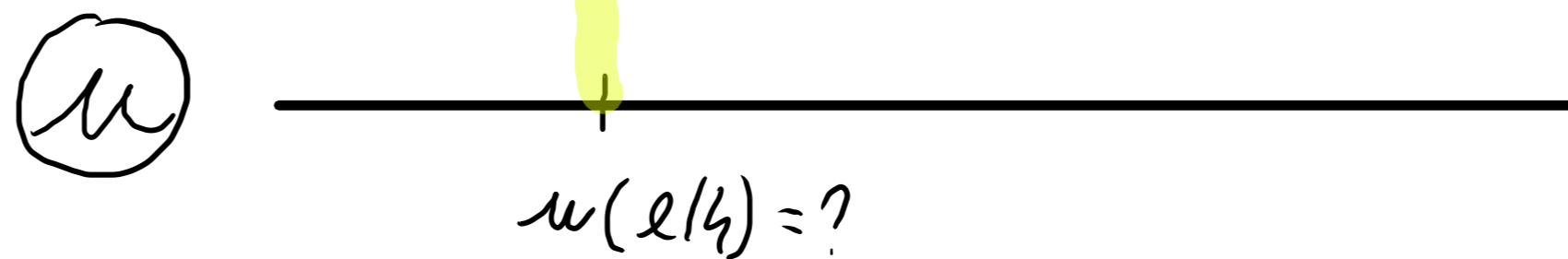
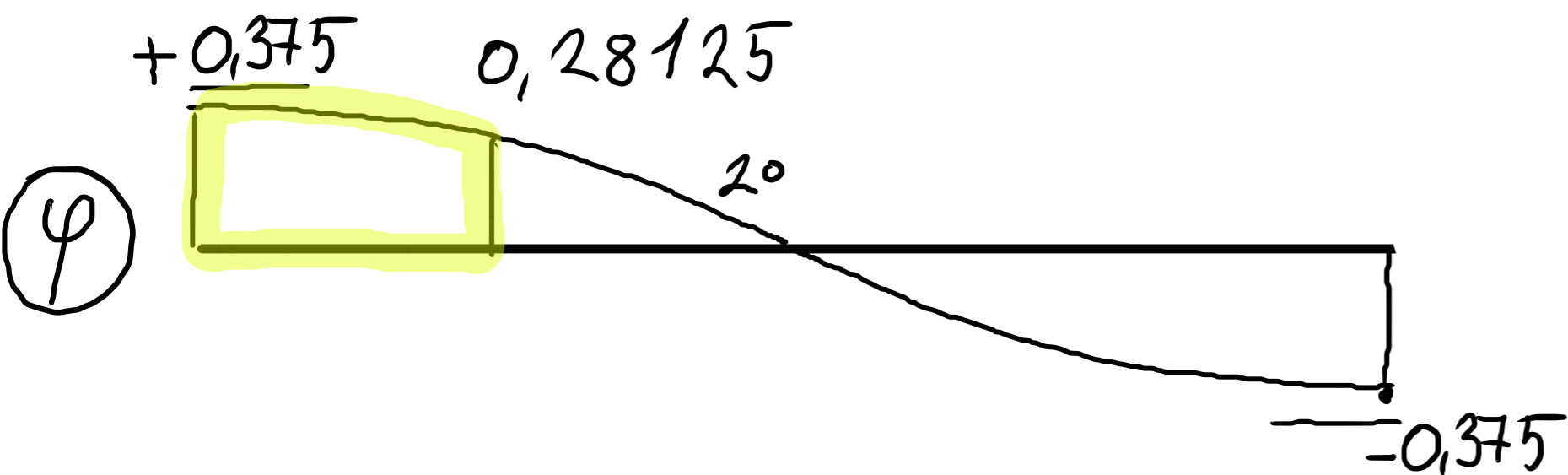
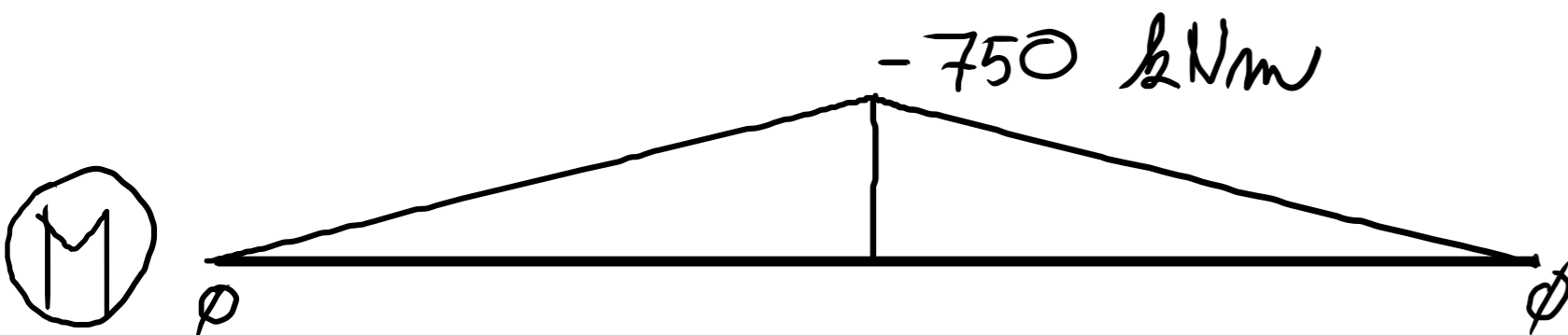
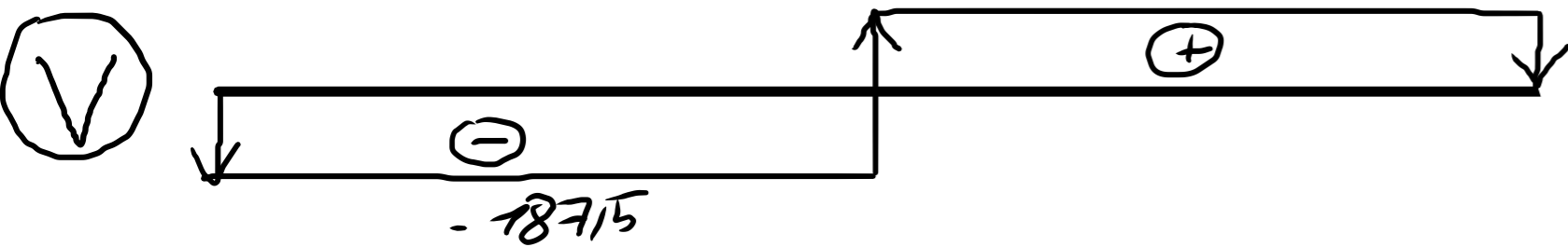

PŘÍČINKOVÉ ČÁRY - S. N. - VYČÍSLENÍ

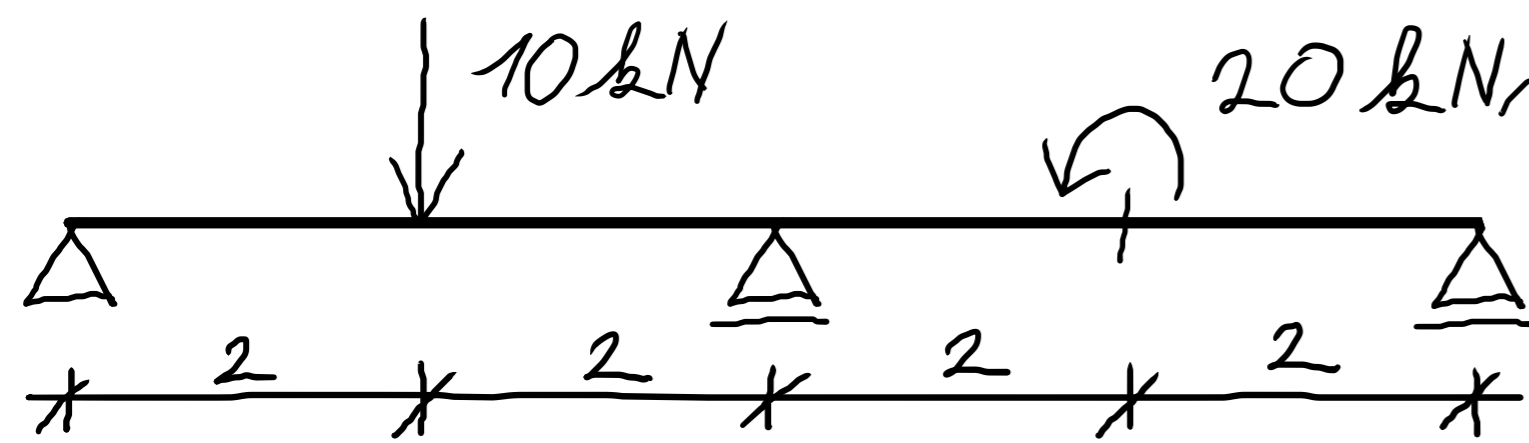

0,2
 0,2 [m]
 $E = 30 \text{ GPa}$

VYČÍSLETE PROSTŘEDNÍ REAKCI

$$I = \frac{1}{12} \cdot 0,2 \cdot 0,2^3 = 1,3 \cdot 10^{-4} \text{ m}^4$$

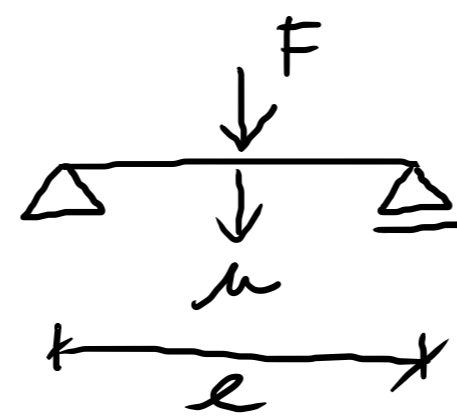
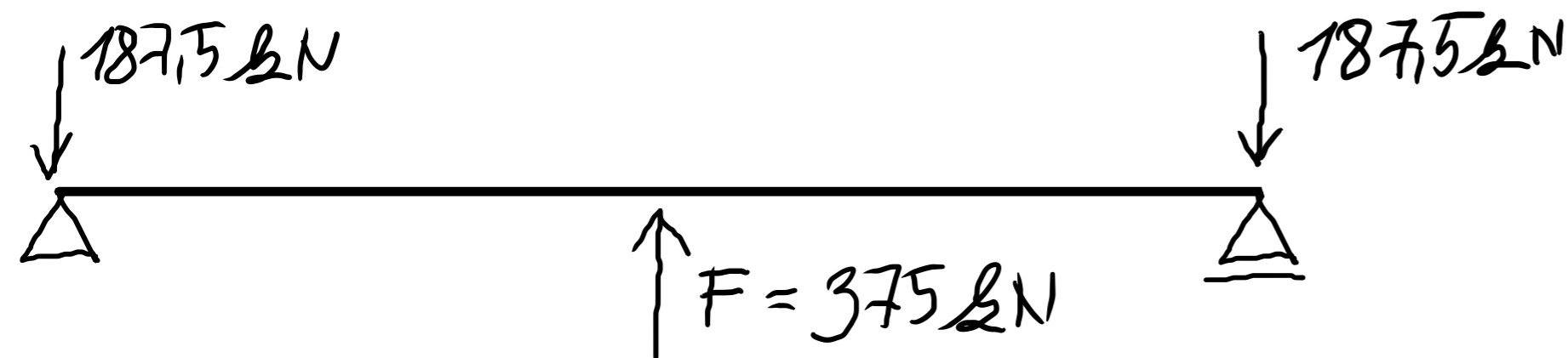

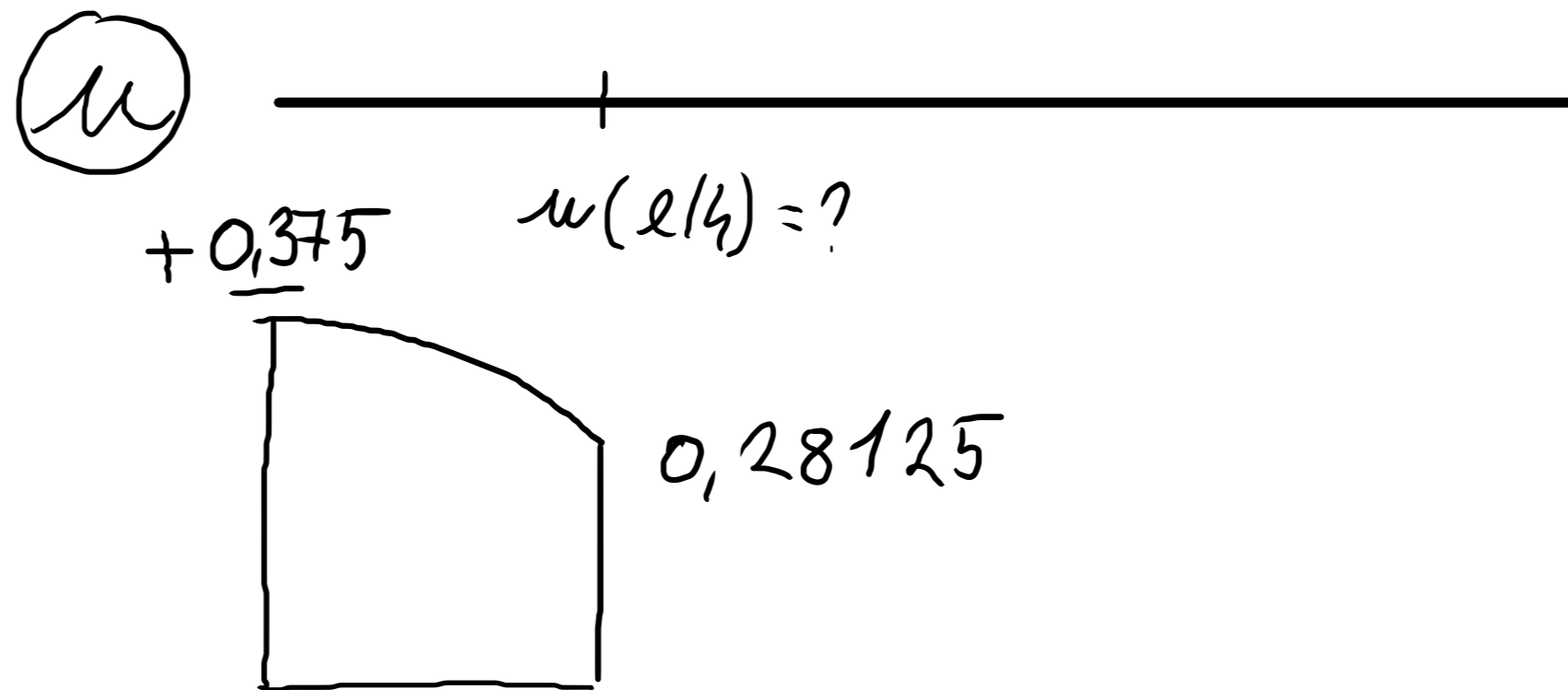
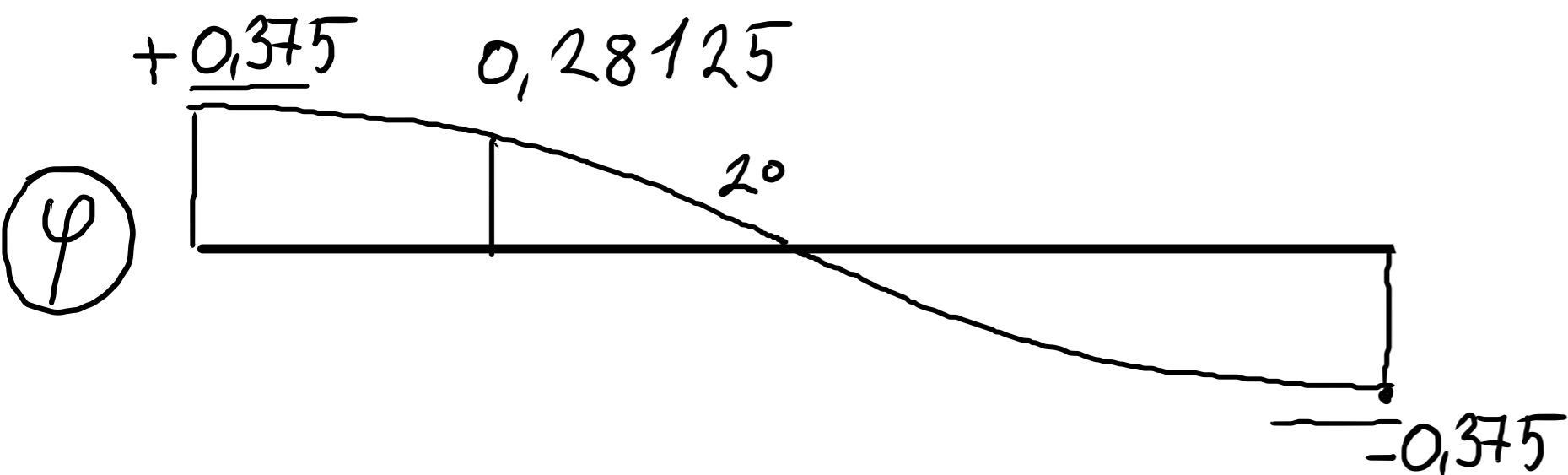
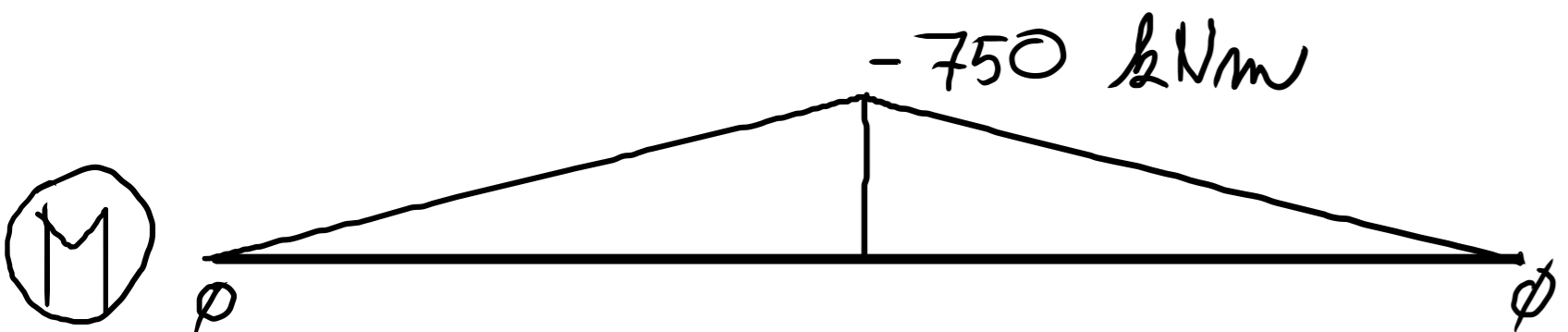
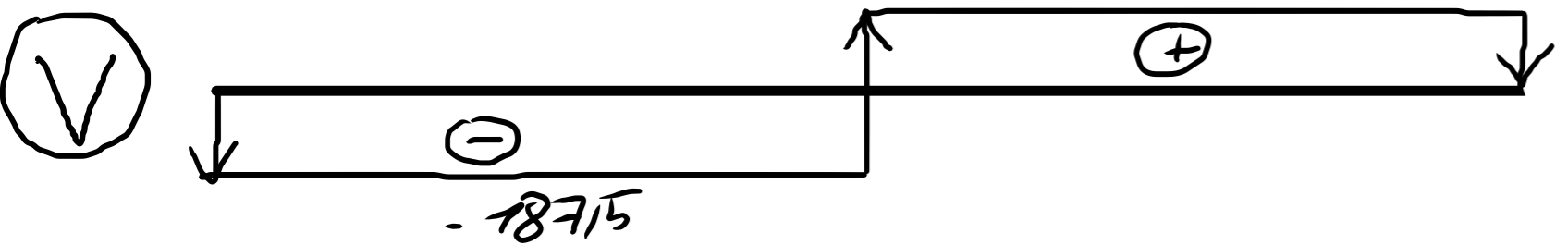

MJS: $w = \frac{Fl^3}{48EI} \rightarrow F = \frac{48EIw}{l^3}$

$$F = \frac{48 \cdot 30 \cdot 10^9 \cdot 1,3 \cdot 10^{-4}}{8^3} = 375\,000 \text{ N} = 375 \text{ kN}$$

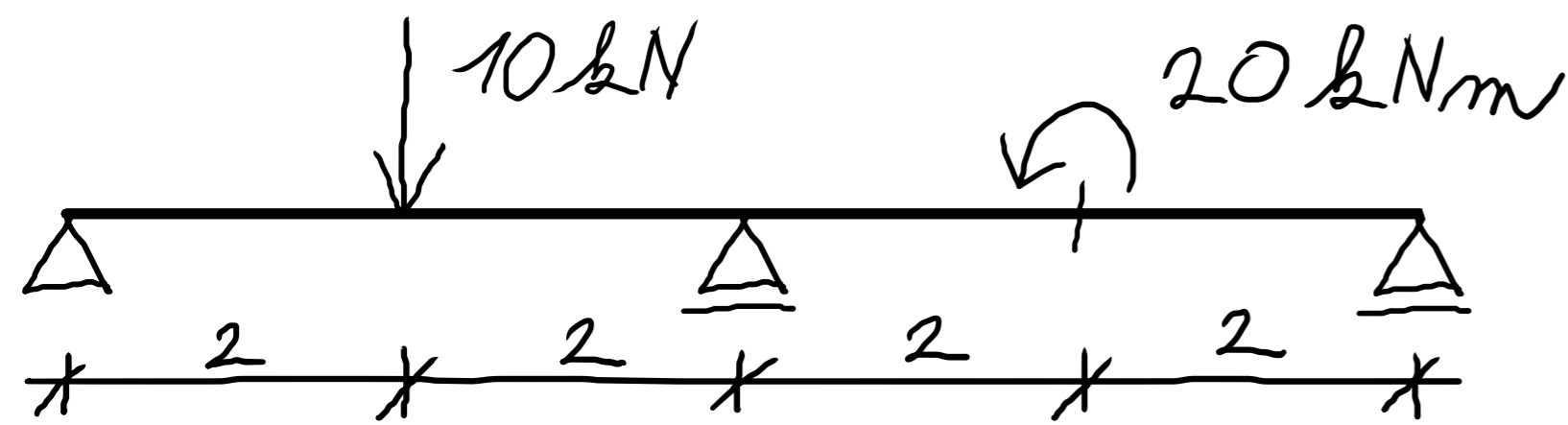

PŘÍČINKOVÉ ČÁRY - S. N. - VYČÍSLENÍ



 0,2
 0,2 [m]
 $E = 30 \text{ GPa}$

VYČÍSLETE PROSTŘEDNÍ REAKCI

$$I = \frac{1}{12} \cdot 0,2 \cdot 0,2^3 = 1,3 \cdot 10^{-4} \text{ m}^4$$

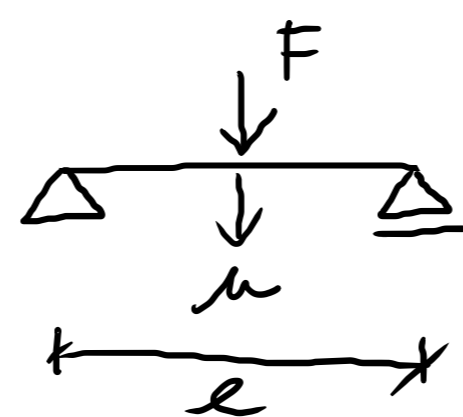
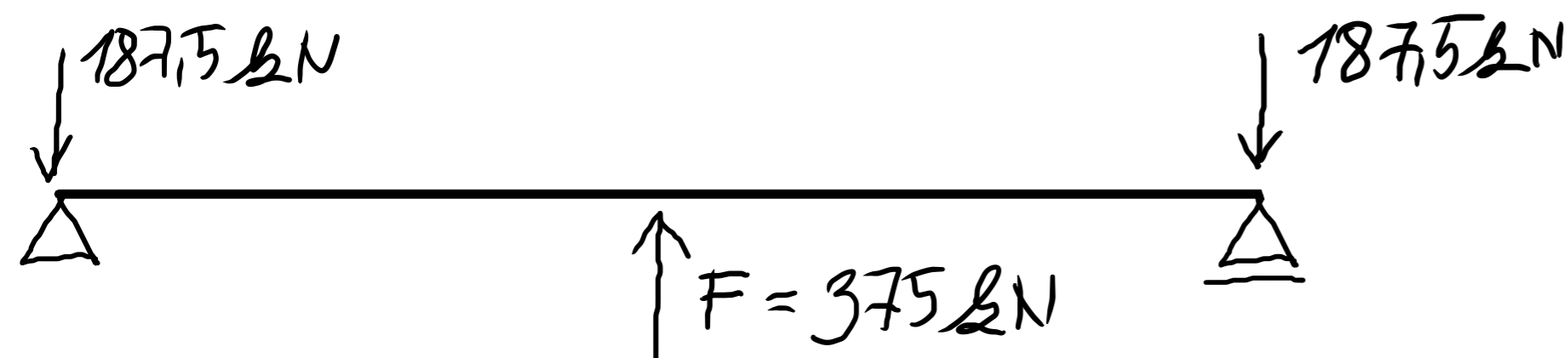

MJS: $w = \frac{Fl^3}{48EI} \rightarrow F = \frac{48EIw}{l^3}$

$$F = \frac{48 \cdot 30 \cdot 10^9 \cdot 1,3 \cdot 10^{-4}}{8^3} = 375\,000 \text{ N} = 375 \text{ kN}$$

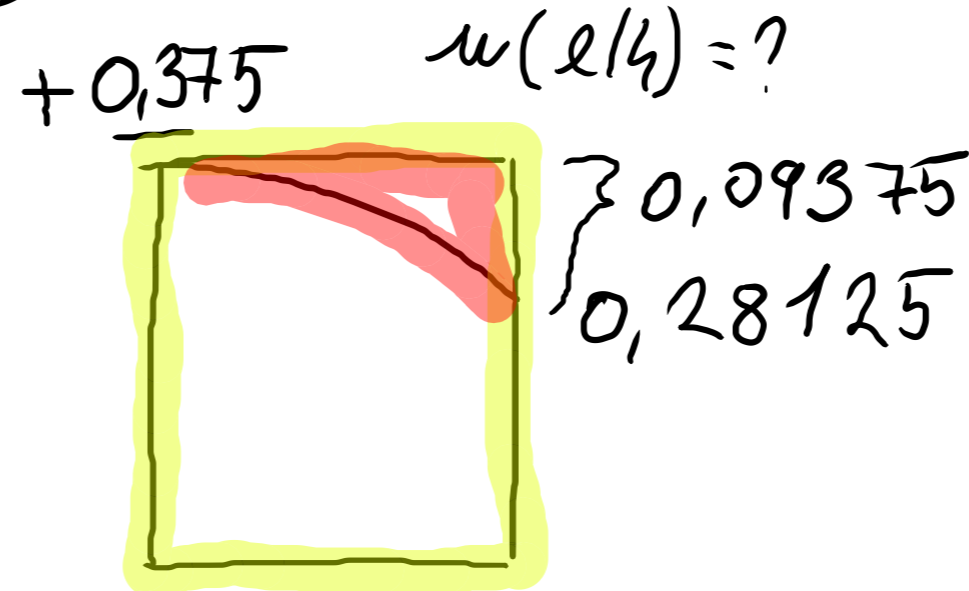
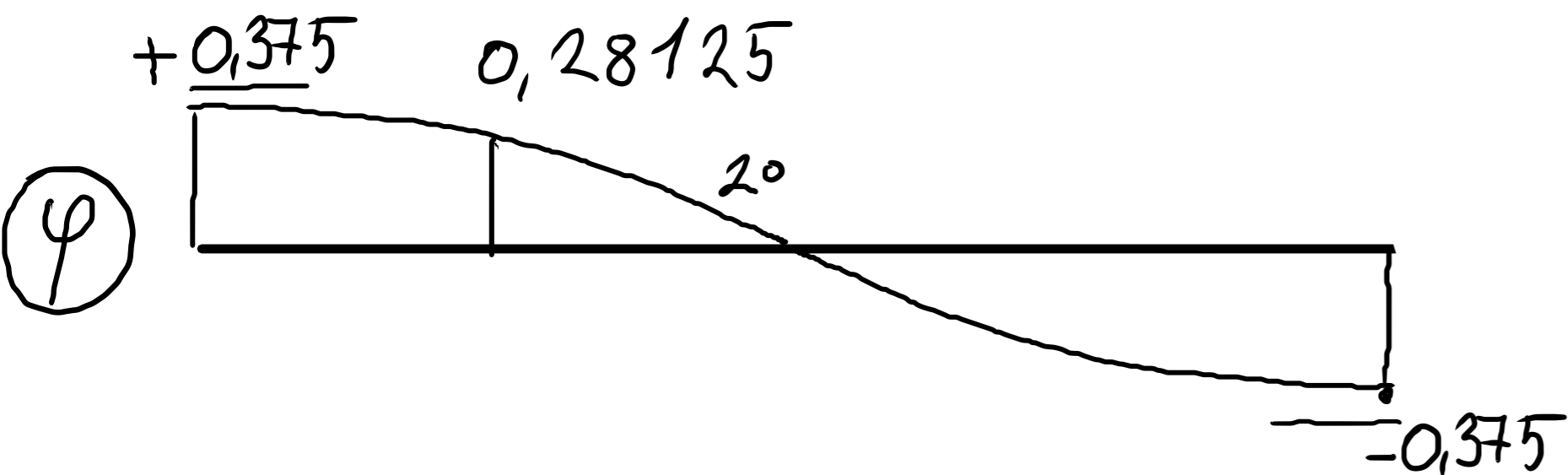
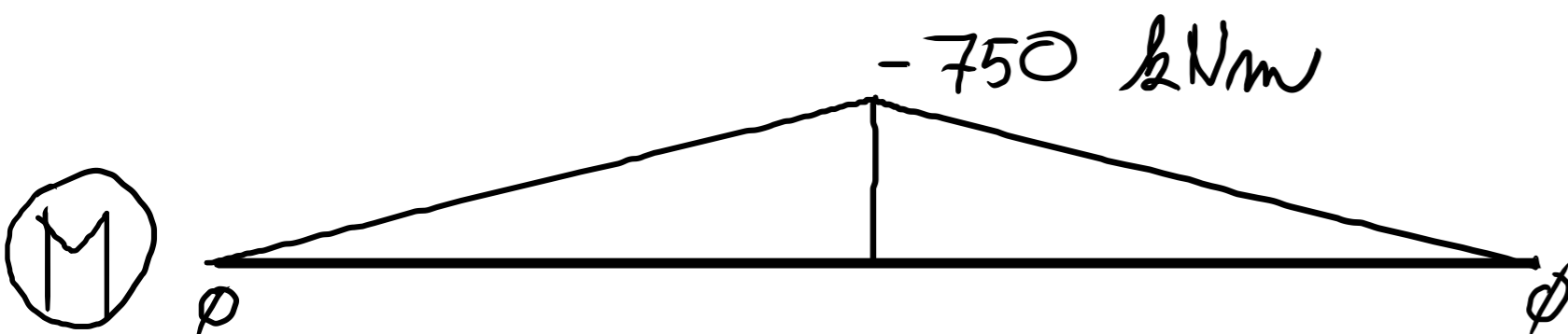
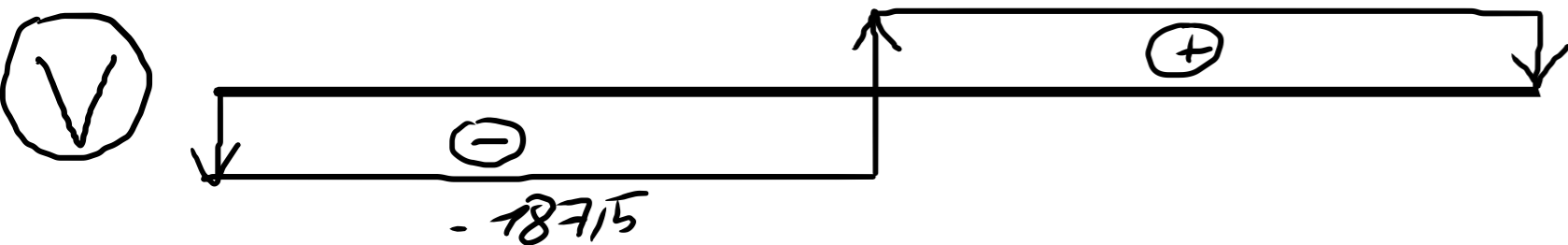

$$2 \cdot 0,375 - \frac{1}{3} 2 \cdot 0,09375 = 0,6875 \text{ m}$$

PŘÍČINKOVÉ ČÁRY - S. N. - VYČÍSLENÍ

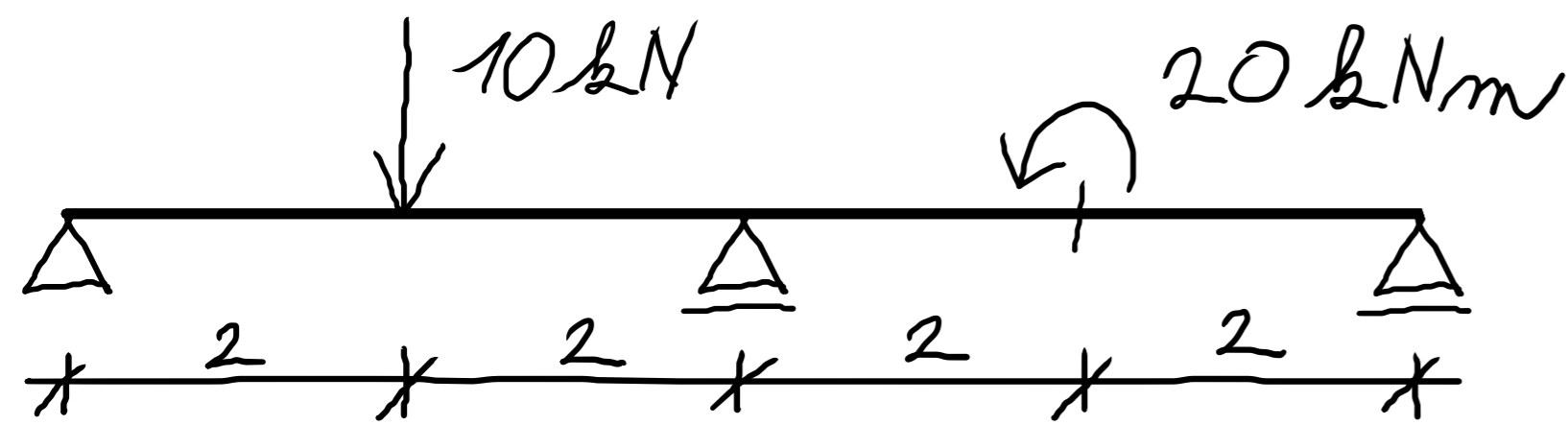

 0,2
 0,2 [m]
 $E = 30 \text{ GPa}$

VYČÍSLETE PROSTŘEDNÍ REAKCI

$$I = \frac{1}{12} \cdot 0,2 \cdot 0,2^3 = 1,3 \cdot 10^{-4} \text{ m}^4$$

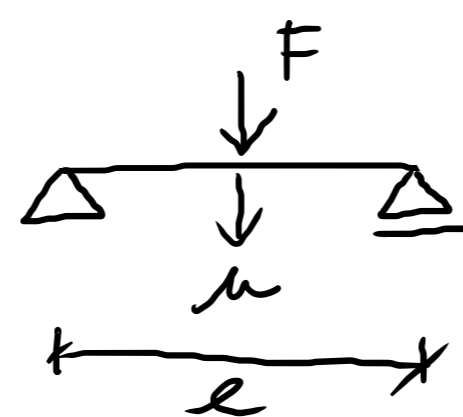
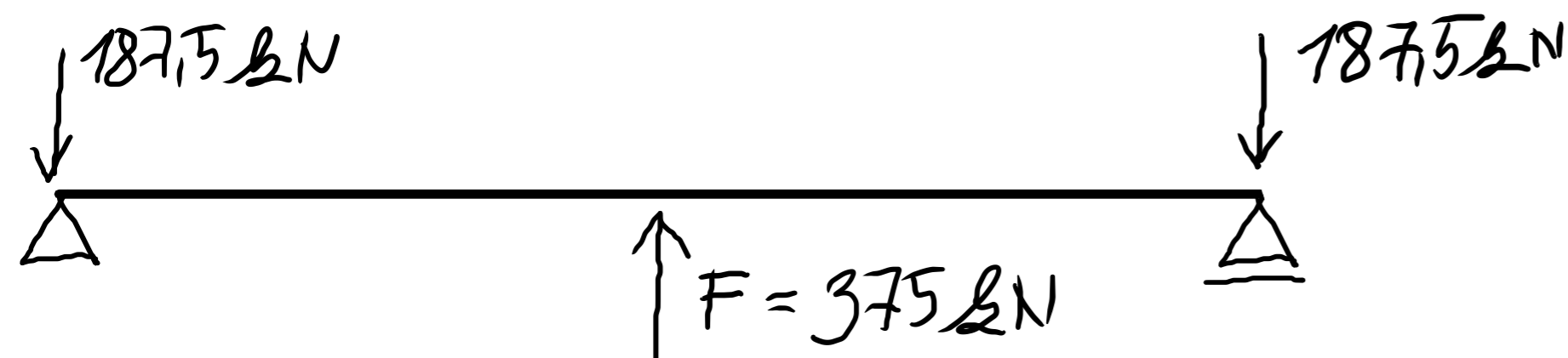

MJS: $w = \frac{Fl^3}{48EI} \rightarrow F = \frac{48EIw}{l^3}$

$$F = \frac{48 \cdot 30 \cdot 10^9 \cdot 1,3 \cdot 10^{-4}}{8^3} = 375\,000 \text{ N} = 375 \text{ kN}$$

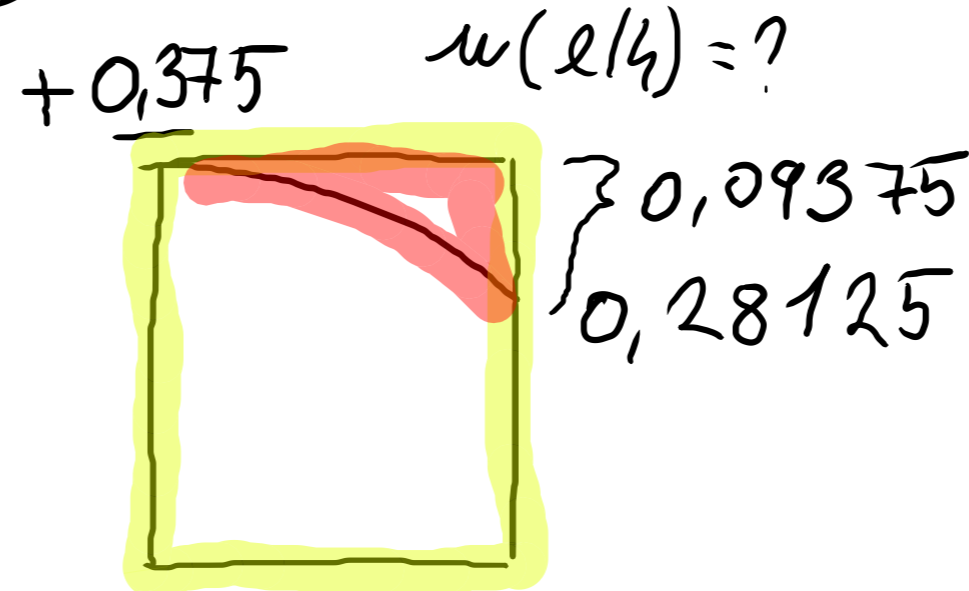
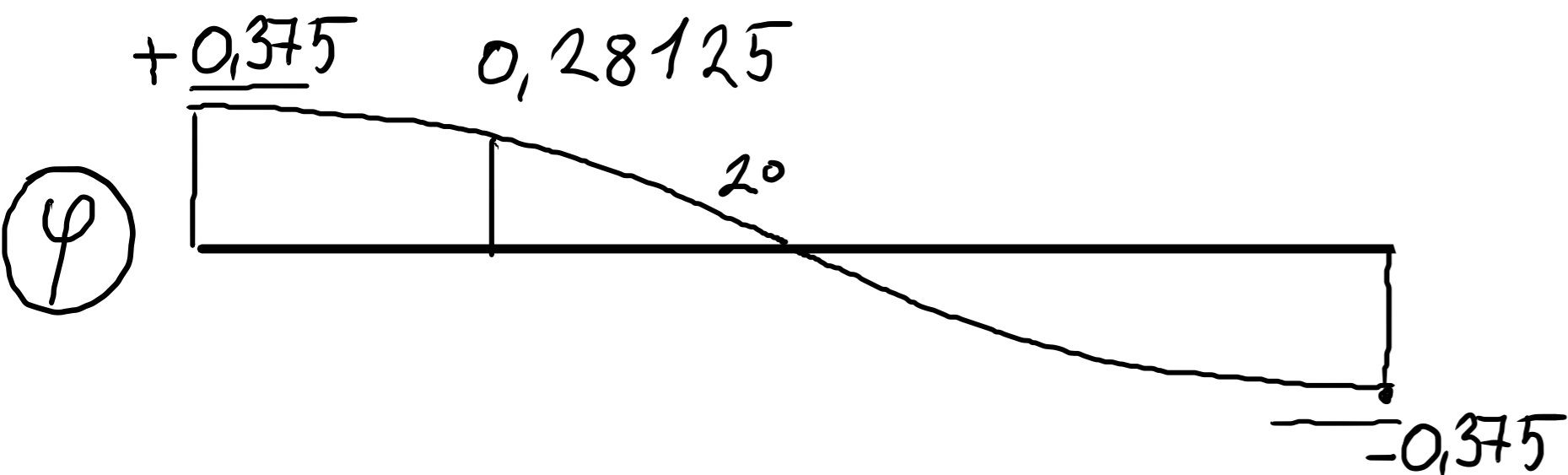
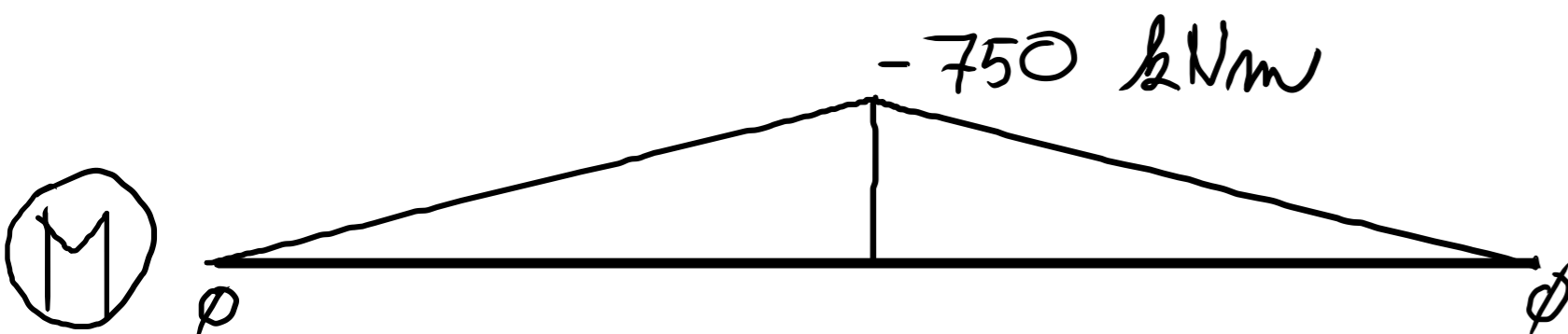
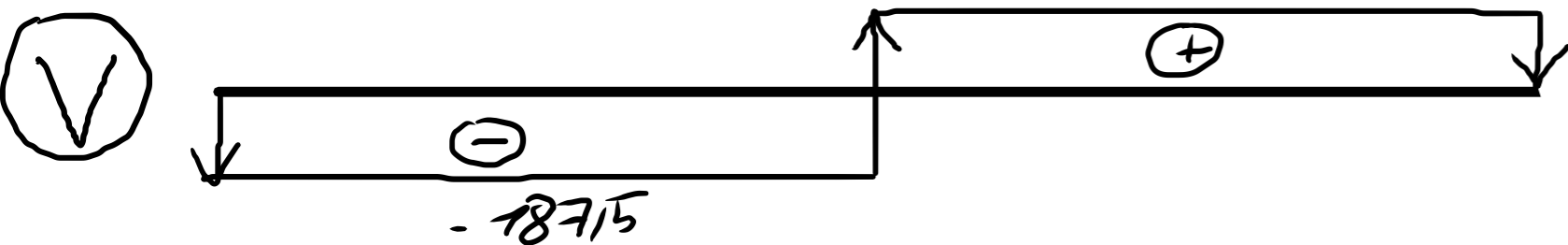

$$2 \cdot 0,375 - \frac{1}{3} 2 \cdot 0,09375 = 0,6875 \text{ m}$$

PŘÍČINKOVÉ ČÁRY - S. N. - VYČÍSLENÍ

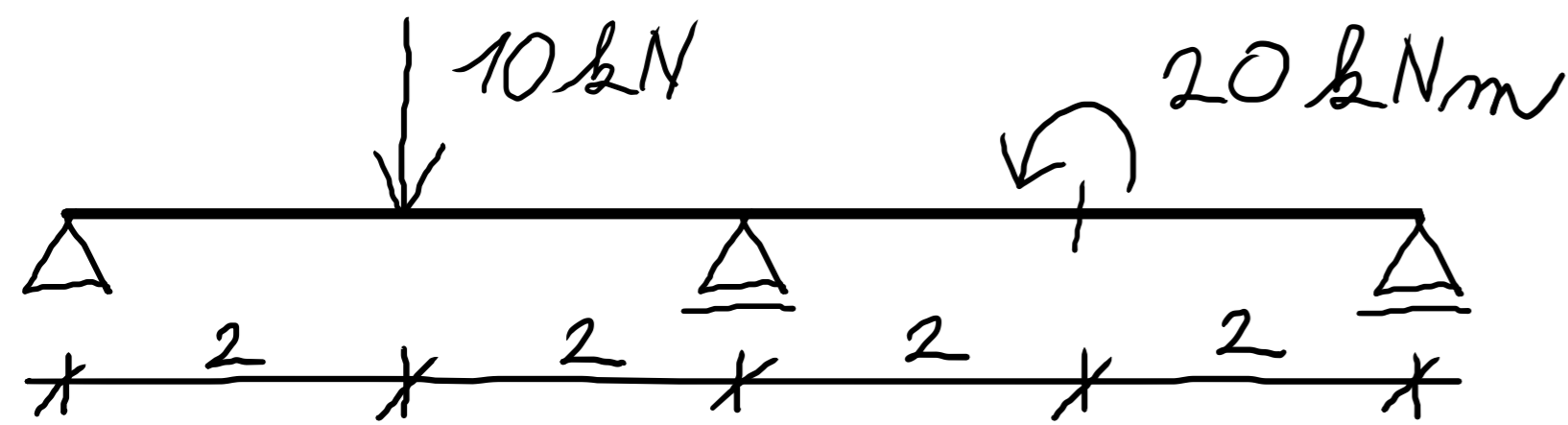

 0,2
 0,2 [m]
 $E = 30 \text{ GPa}$

VYČÍSLETE PROSTŘEDNÍ REAKCI

$$I = \frac{1}{12} \cdot 0,2 \cdot 0,2^3 = 1,3 \cdot 10^{-4} \text{ m}^4$$

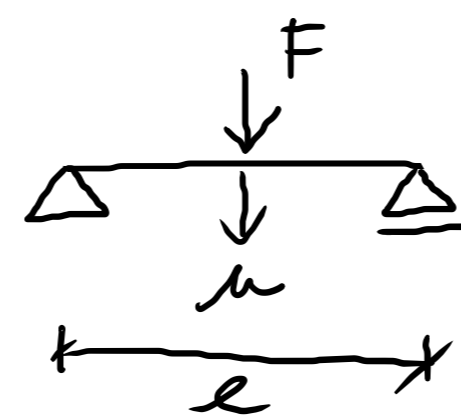
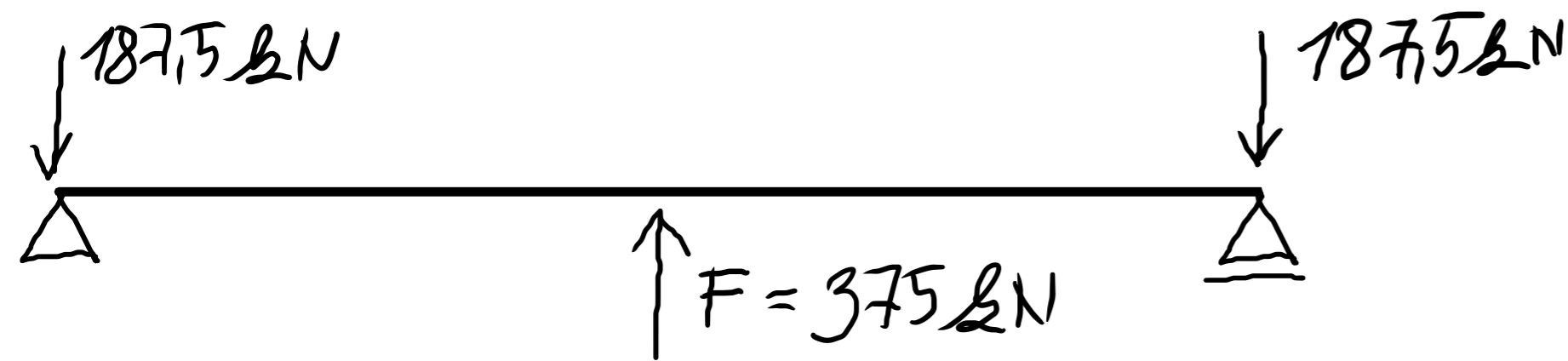

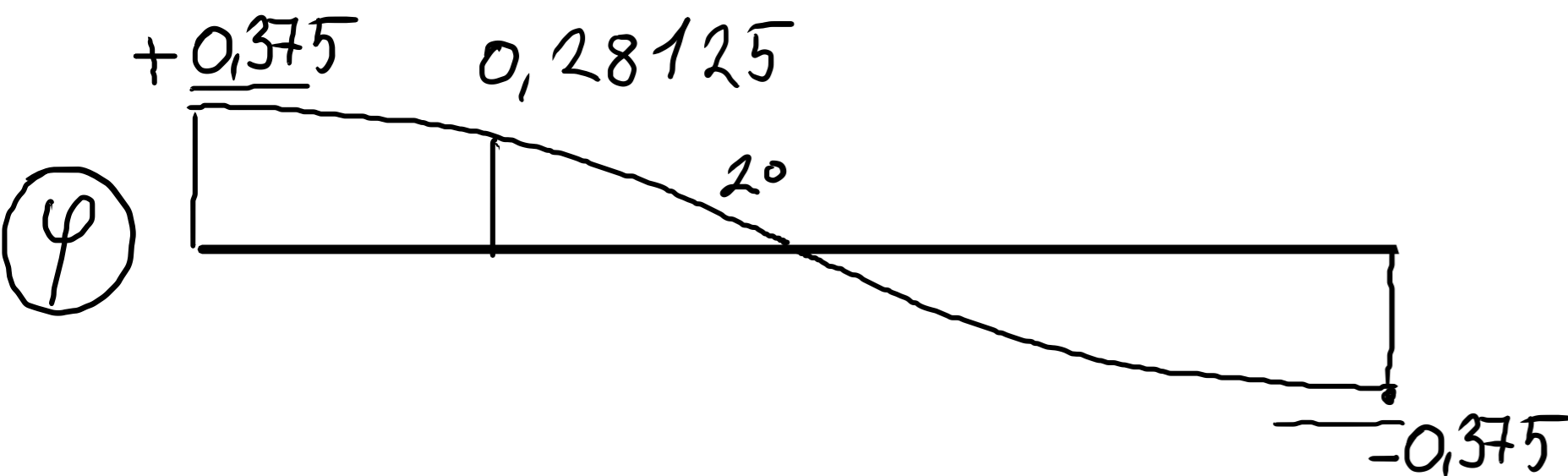
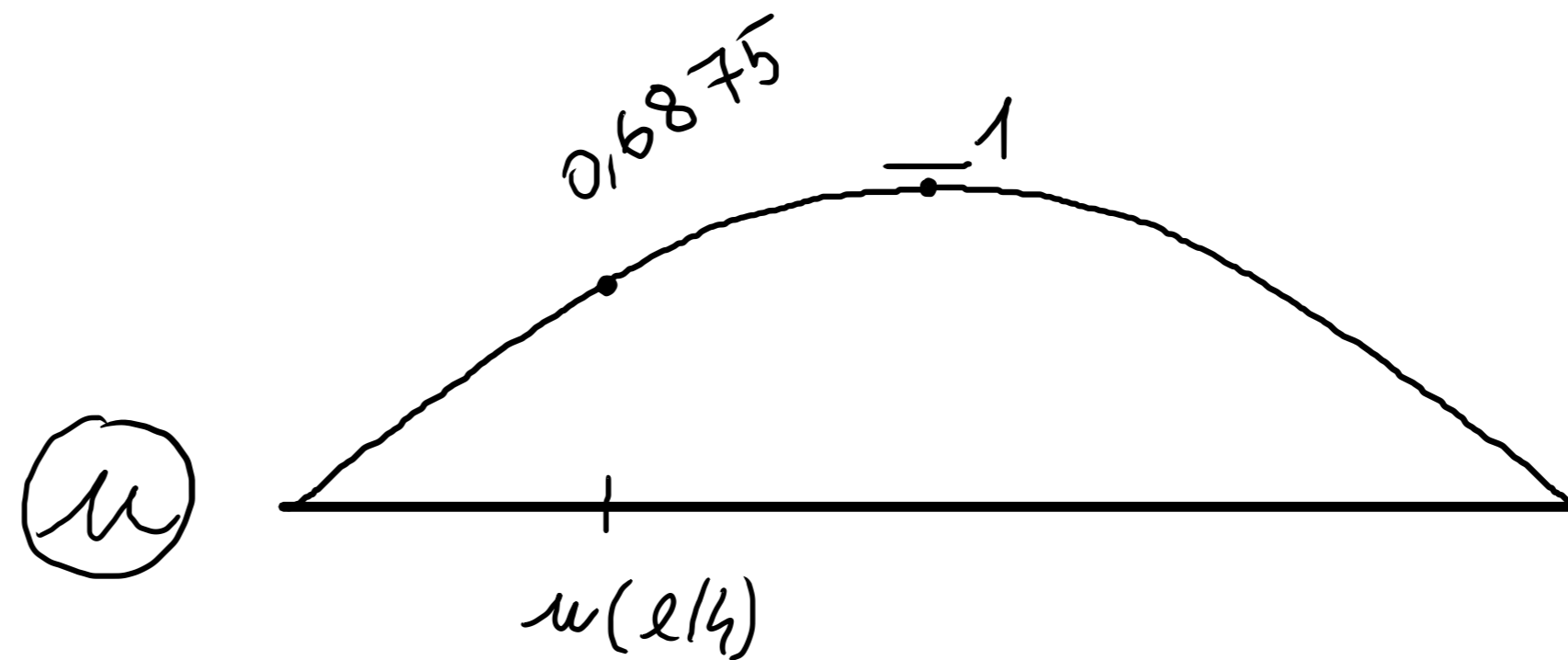
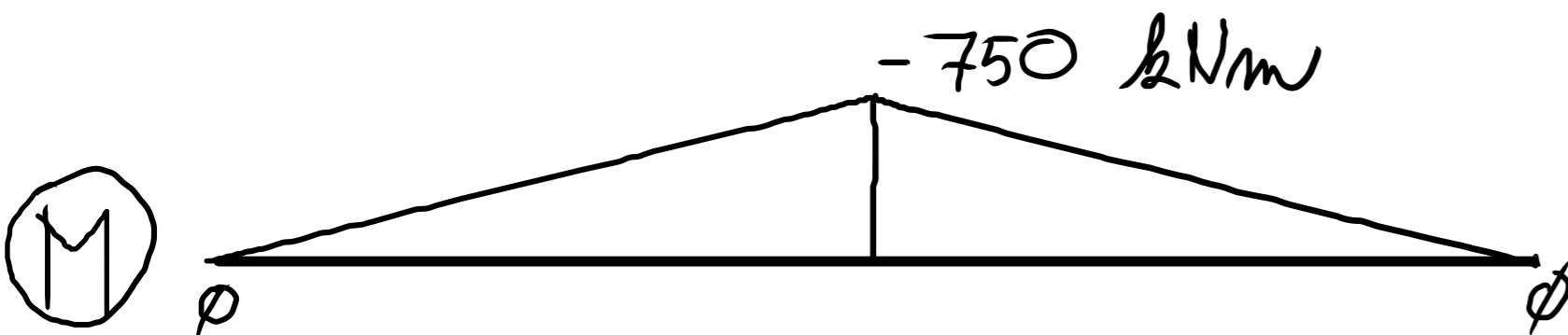
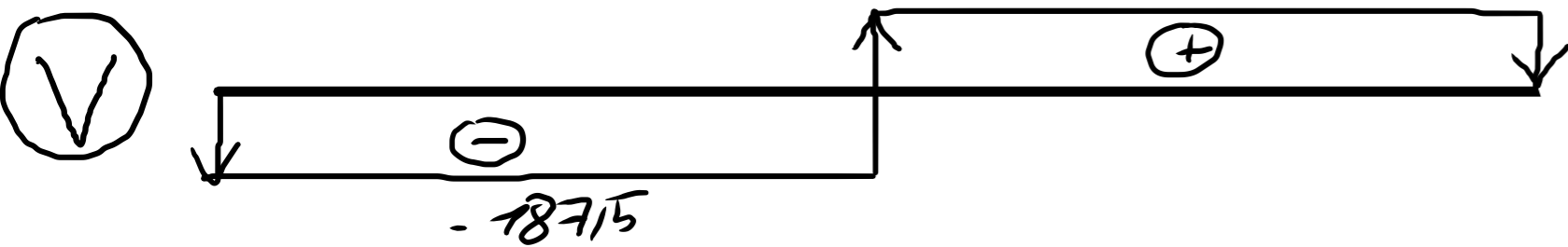

MJS: $w = \frac{Fl^3}{48EI} \rightarrow F = \frac{48EIw}{l^3}$

$$F = \frac{48 \cdot 30 \cdot 10^9 \cdot 1,3 \cdot 10^{-4}}{8^3} = 375000 \text{ N} = 375 \text{ kN}$$

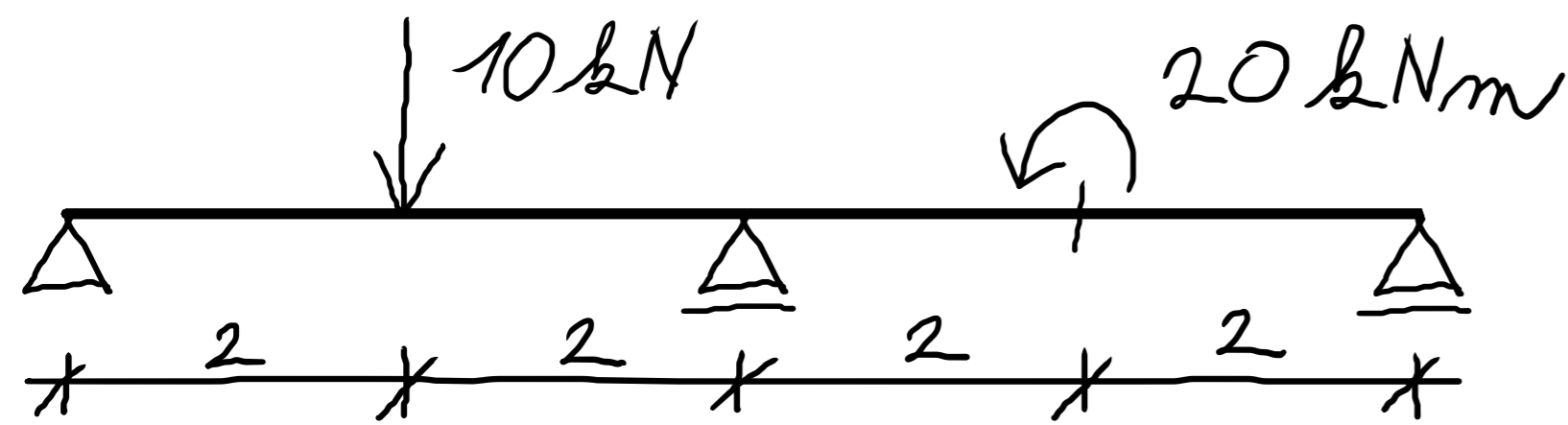

PŘÍČINKOVÉ ČÁRY - S. N. - VYČÍSLENÍ



 0,2
 0,2 [m]
 $E = 30 \text{ GPa}$

VYČÍSLETE PROSTŘEDNÍ REAKCI

$$I = \frac{1}{12} \cdot 0,2 \cdot 0,2^3 = 1,3 \cdot 10^{-4} \text{ m}^4$$

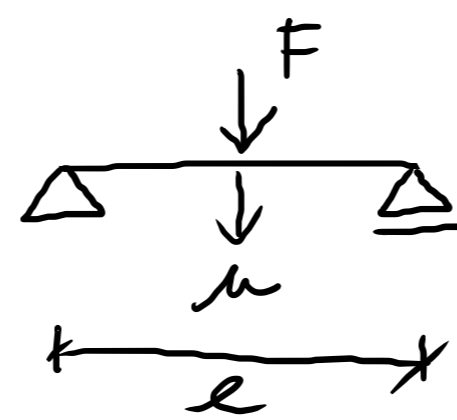
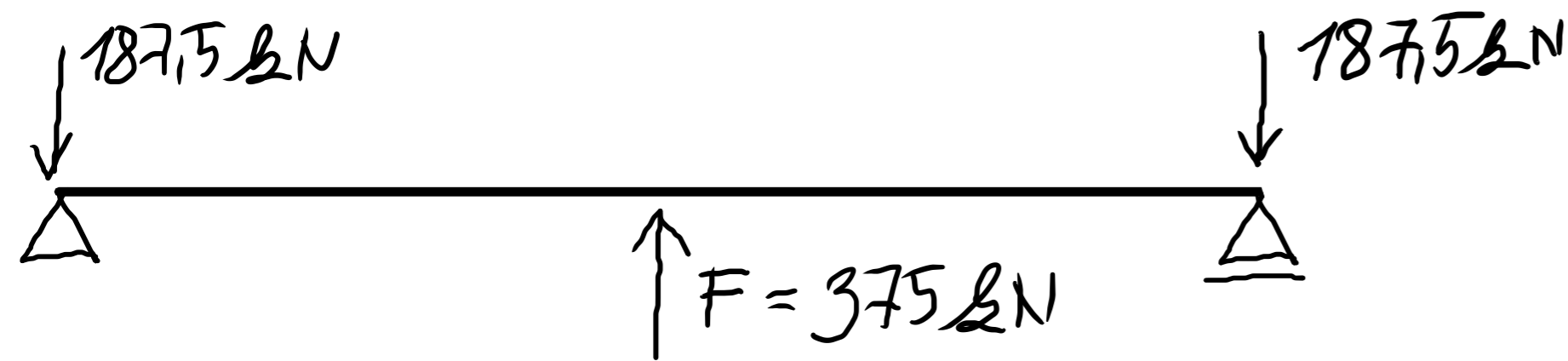

MJS: $w = \frac{Fl^3}{48EI} \rightarrow F = \frac{48EIw}{l^3}$

$$F = \frac{48 \cdot 30 \cdot 10^9 \cdot 1,3 \cdot 10^{-4}}{8^3} = 375\,000 \text{ N} = 375 \text{ kN}$$

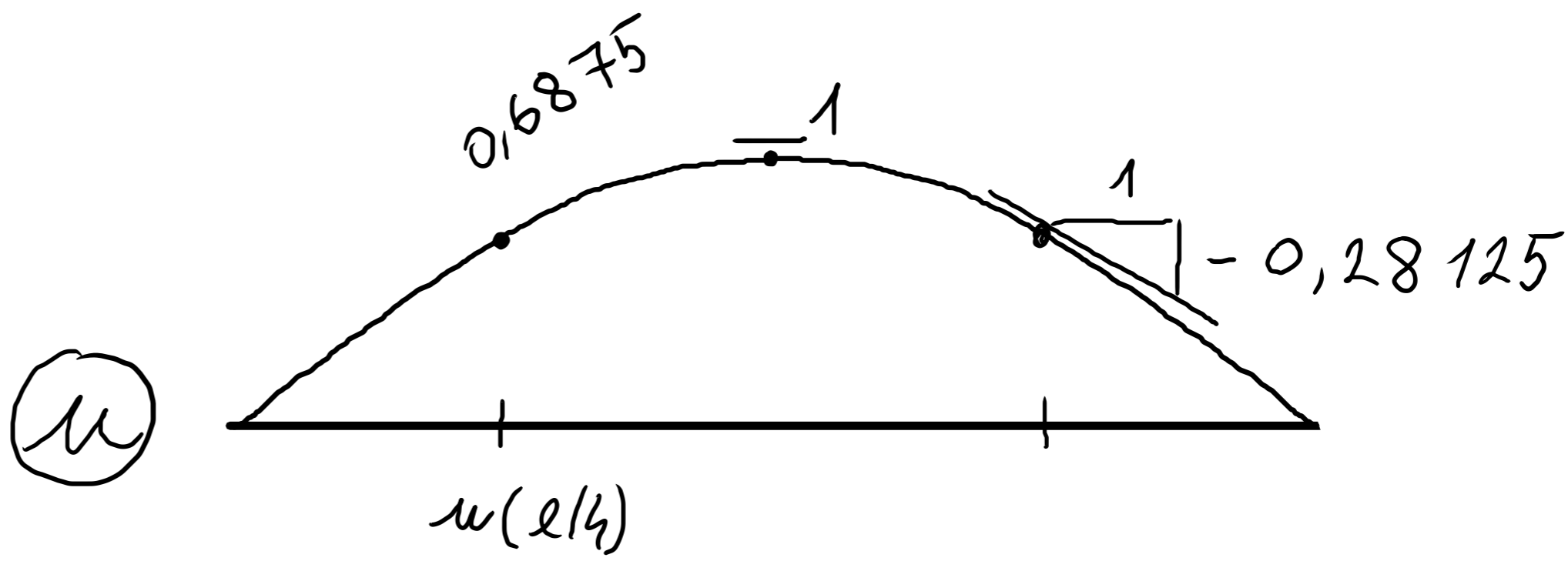
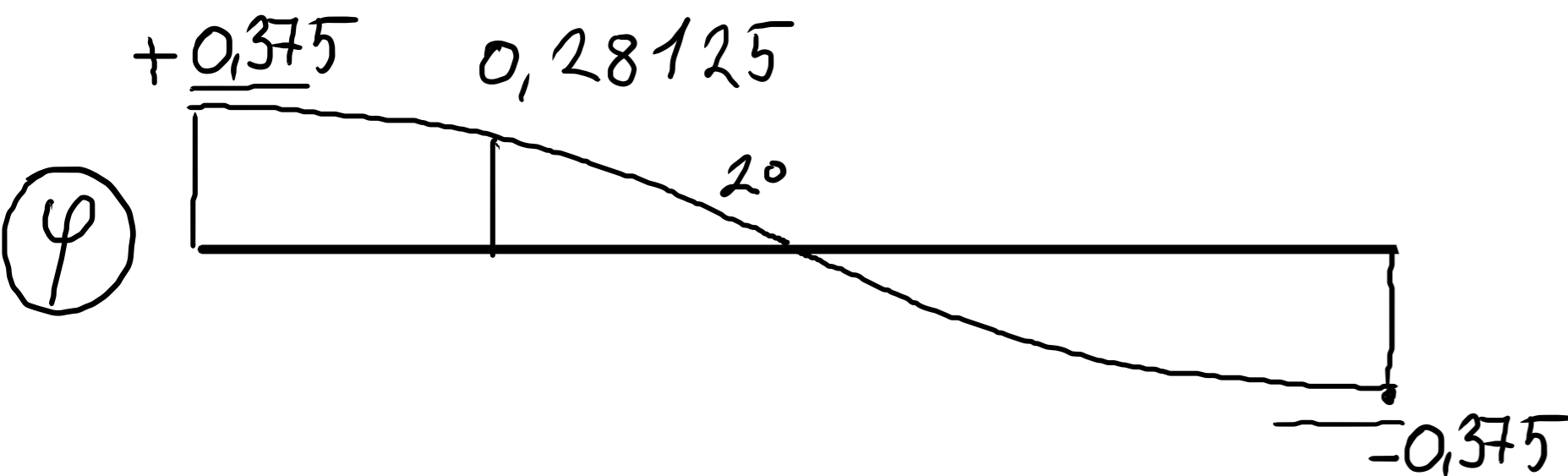
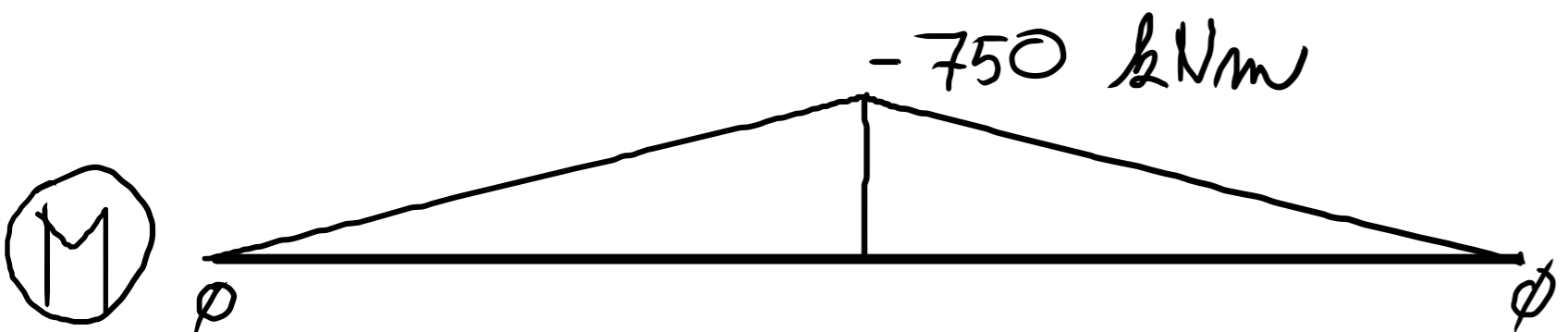
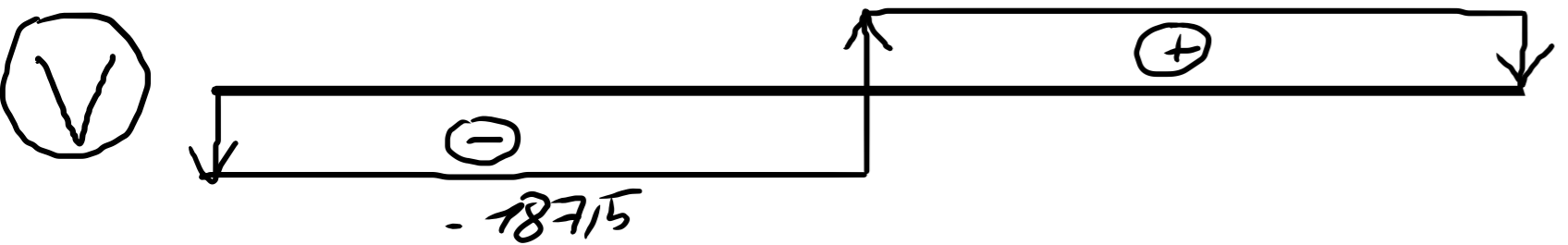

PŘÍČINKOVÉ ČÁRY - S. N. - VYČÍSLENÍ

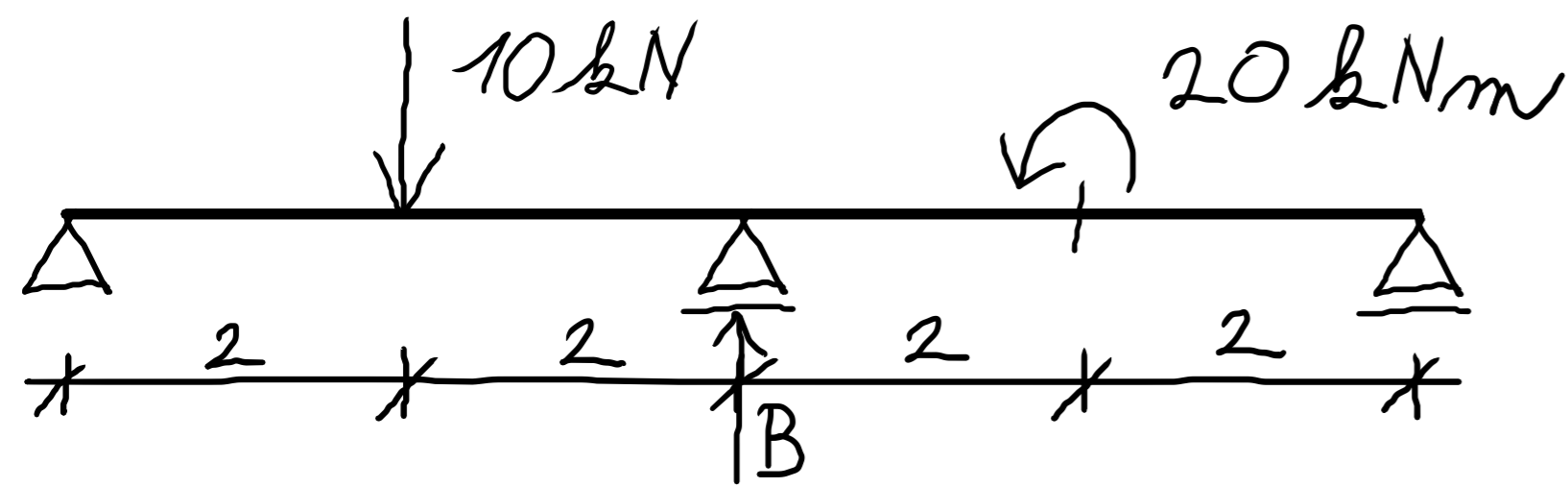

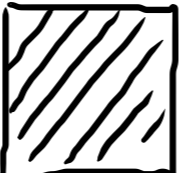
 0,2
 0,2 [m]
 $E = 30 \text{ GPa}$

VYČÍSLETE PROSTŘEDNÍ REAKCI

$$I = \frac{1}{12} \cdot 0,2 \cdot 0,2^3 = 1,3 \cdot 10^{-4} \text{ m}^4$$

B

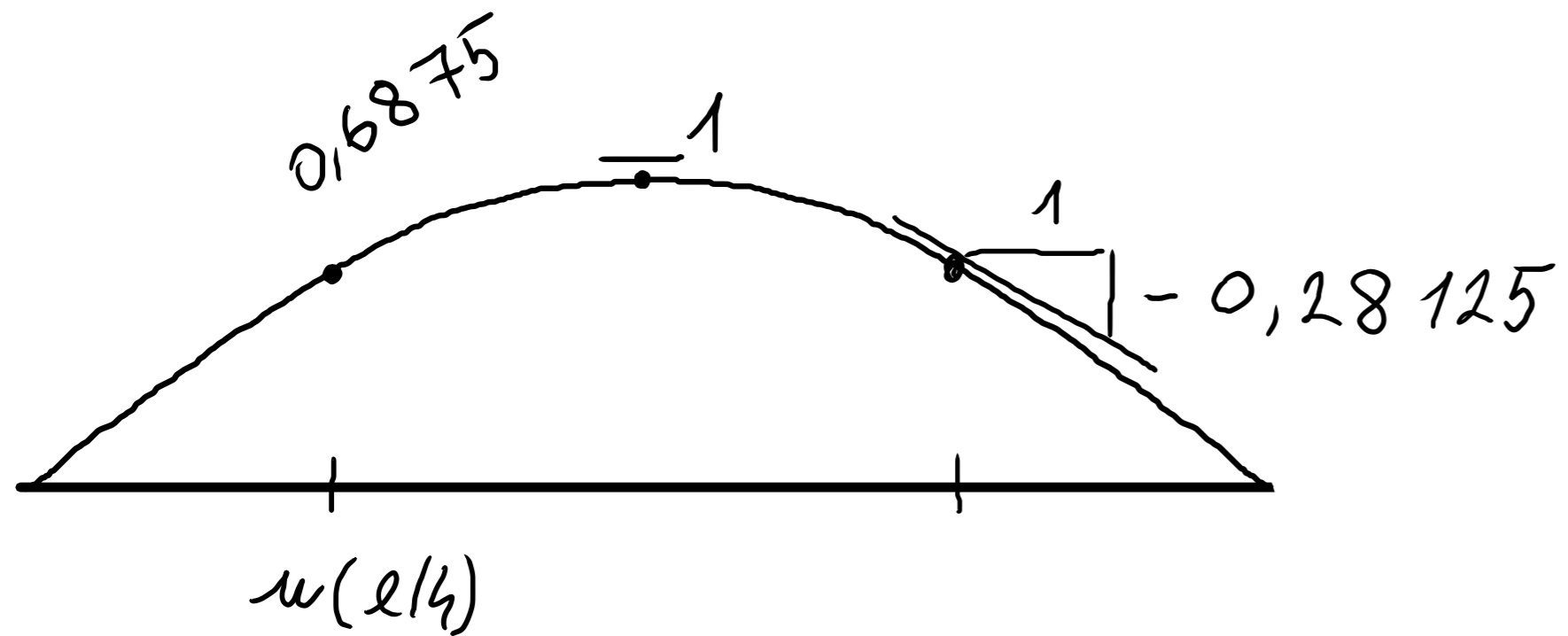

PŘÍČINKOVÉ ČÁRY - S. N. - VYČÍSLENÍ

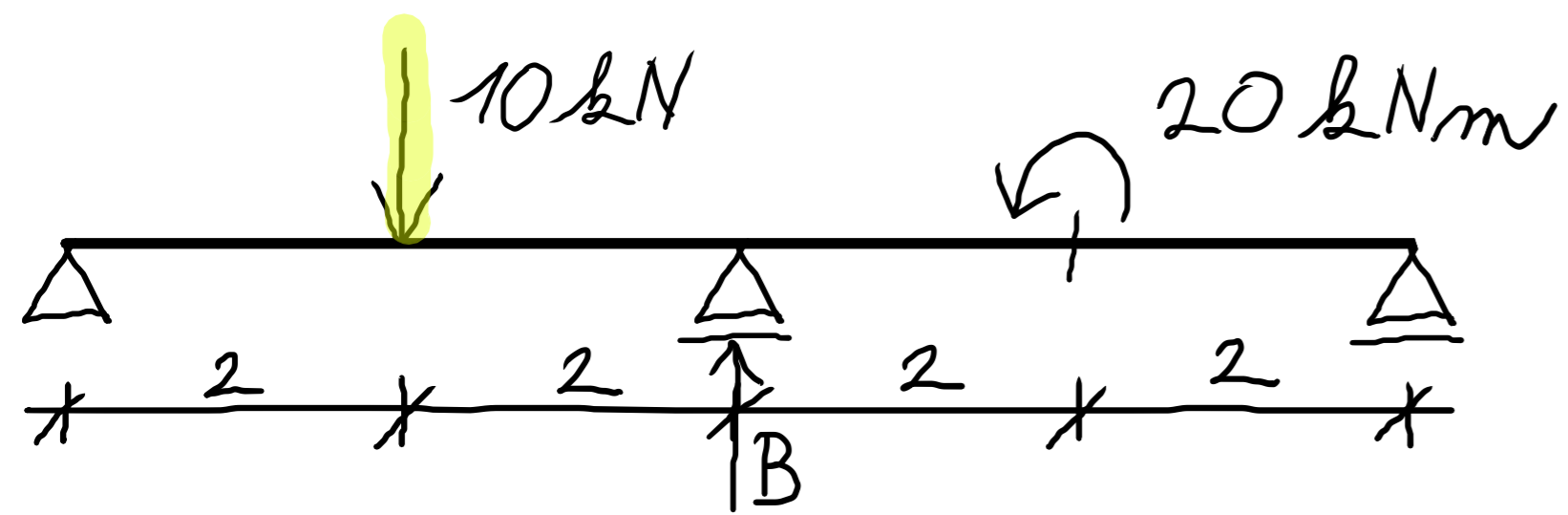

$0,2$
 $0,2$ [m]
 $E = 30$ GPa

VYČÍSLETE PROSTŘEDNÍ REAKCI

$$I = \frac{1}{12} \cdot 0,2 \cdot 0,2^3 = 1,3 \cdot 10^{-4} \text{ m}^4$$

B

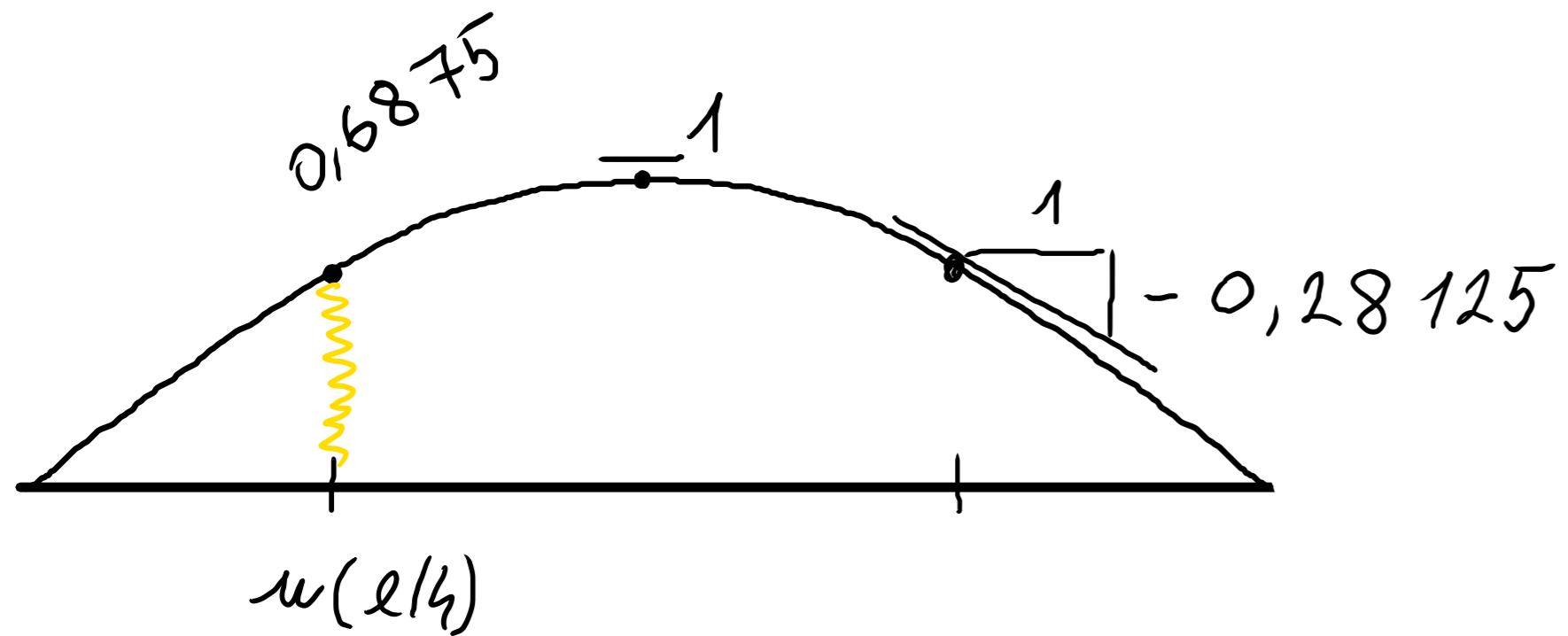

$$B = 10 \cdot 0,6875$$

PŘÍČINKOVÉ ČÁRY - S. N. - VYČÍSLENÍ

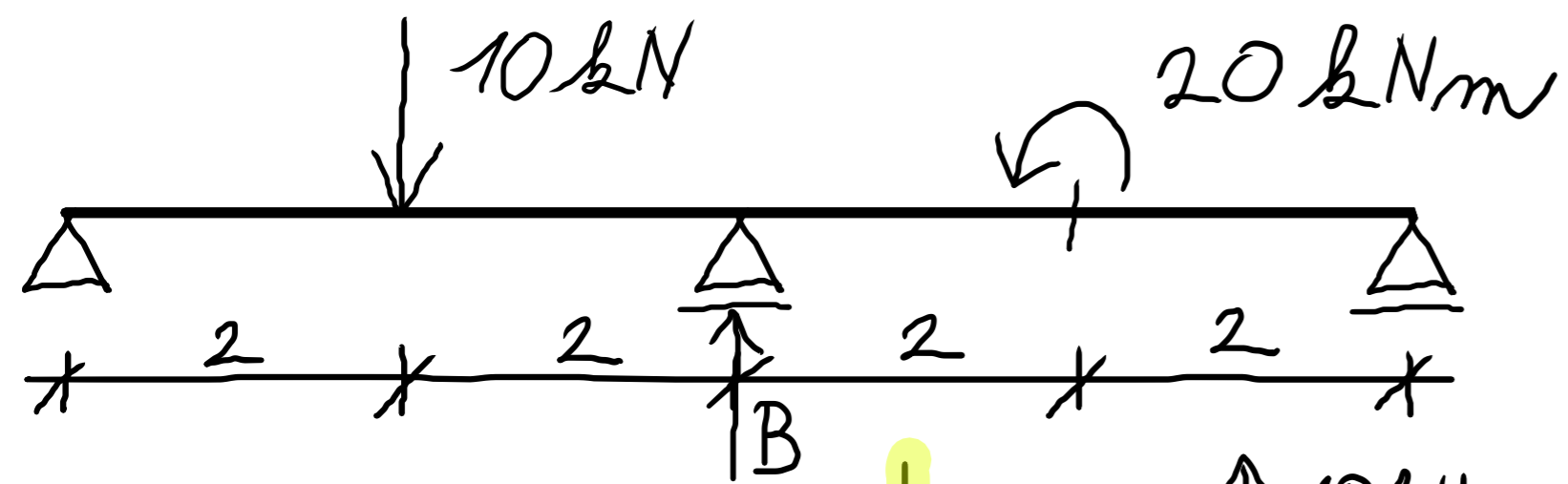

$0,2$
 $0,2$ [m]
 $E = 30$ GPa

VYČÍSLETE PROSTŘEDNÍ REAKCI

$$I = \frac{1}{12} \cdot 0,2 \cdot 0,2^3 = 1,3 \cdot 10^{-4} \text{ m}^4$$

B

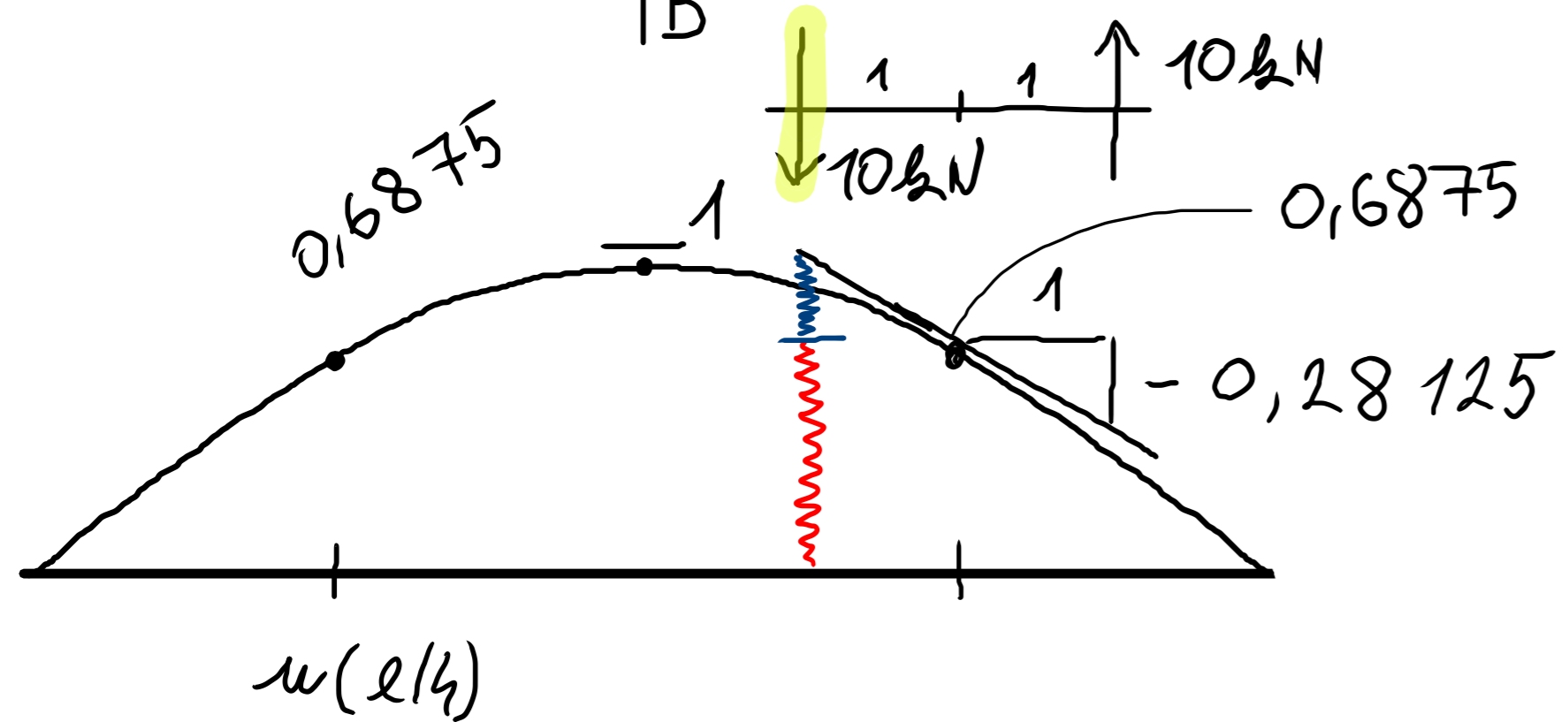

$$B = 10 \cdot 0,6875 + 10 \cdot (0,6875 + 0,28125)$$

PŘÍČINKOVÉ ČÁRY - S. N. - VYČÍSLENÍ

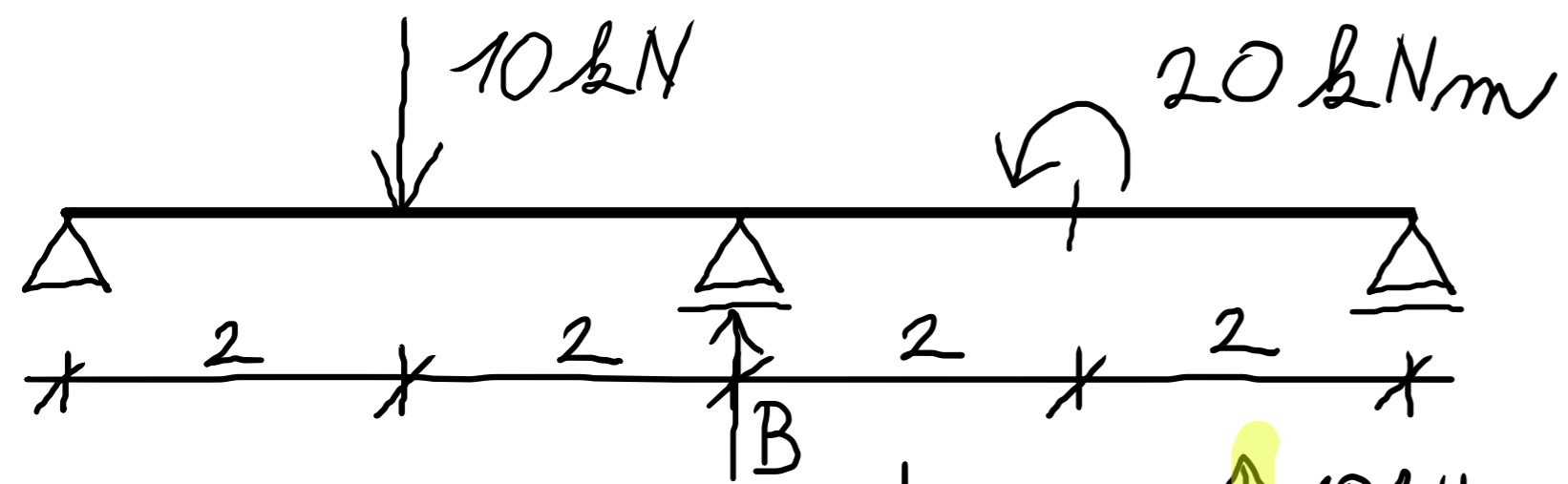

VYČÍSLETE PROSTŘEDNÍ REAKCI

$$I = \frac{1}{12} \cdot 0,2 \cdot 0,2^3 = 1,3 \cdot 10^{-4} \text{ m}^4$$

B

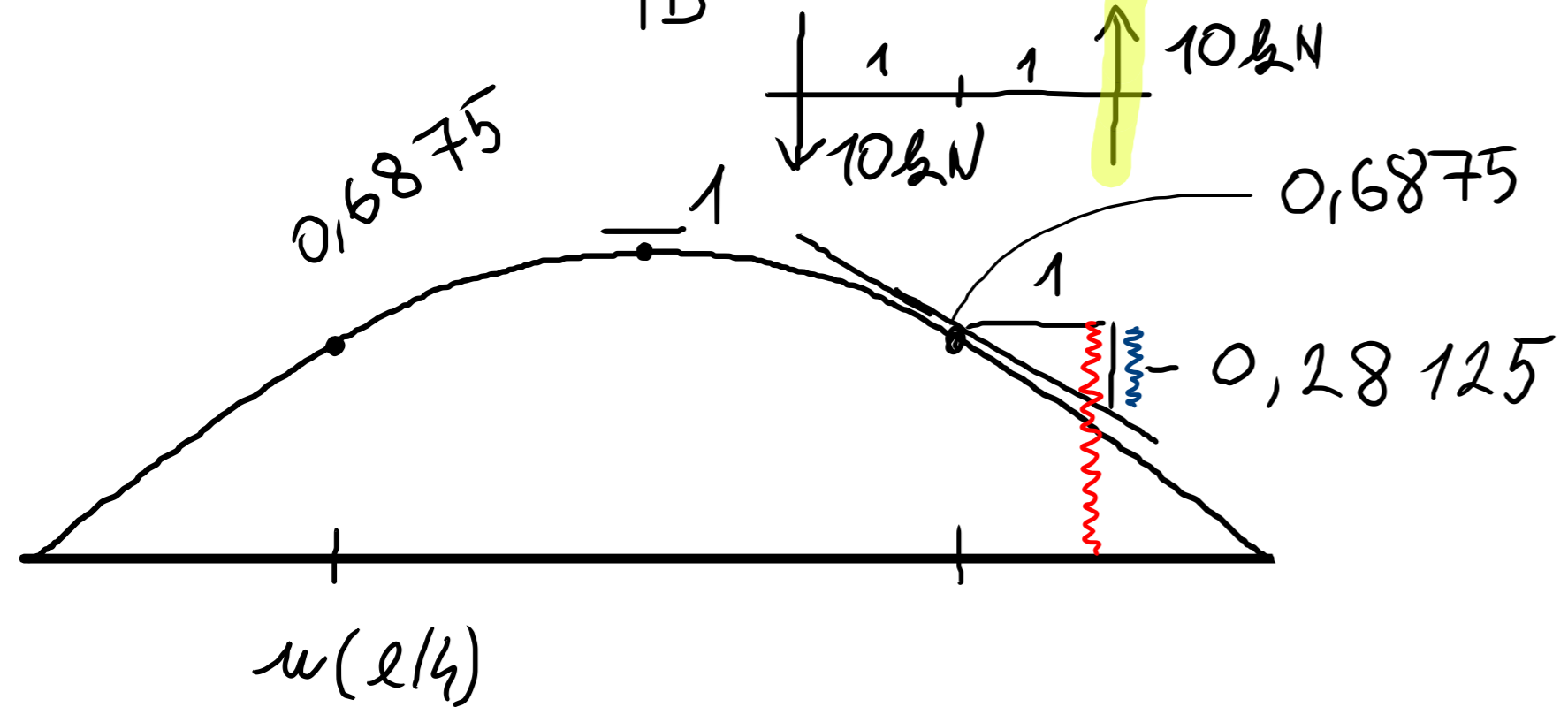

$$B = 10 \cdot 0,6875 + 10 \cdot (0,6875 + 0,28125) - 10 \cdot (0,6875 - 0,28125) = \underline{\underline{12,5 \text{ kN}}}$$

PŘÍČINKOVÉ ČÁRY - UMÍSTĚNÍ ZATÍŽENÍ

PŘÍČINKOVÉ ČÁRY - UMÍSTĚNÍ ZATÍŽENÍ

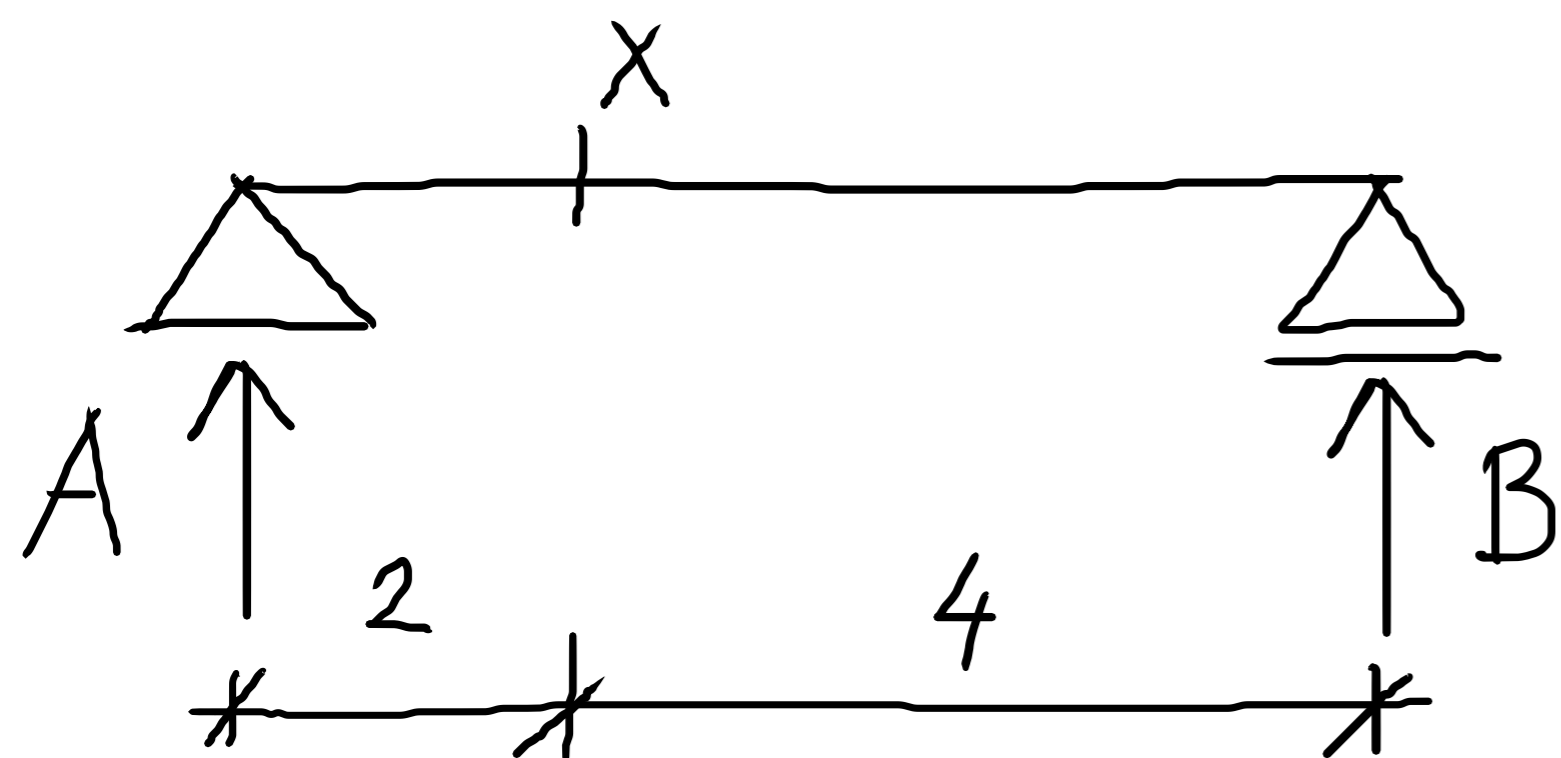

UMÍSTĚTE SPOJITÉ ZATÍŽENÍ DÉLKY 2m TAK,
ŽE V MÍSTĚ X ZPŮSOBI MAXIMÁLNÍ
OHYBOVÝ MOMENT.

PŘÍČINKOVÉ ČÁRY - UMÍSTĚNÍ ZATÍŽENÍ

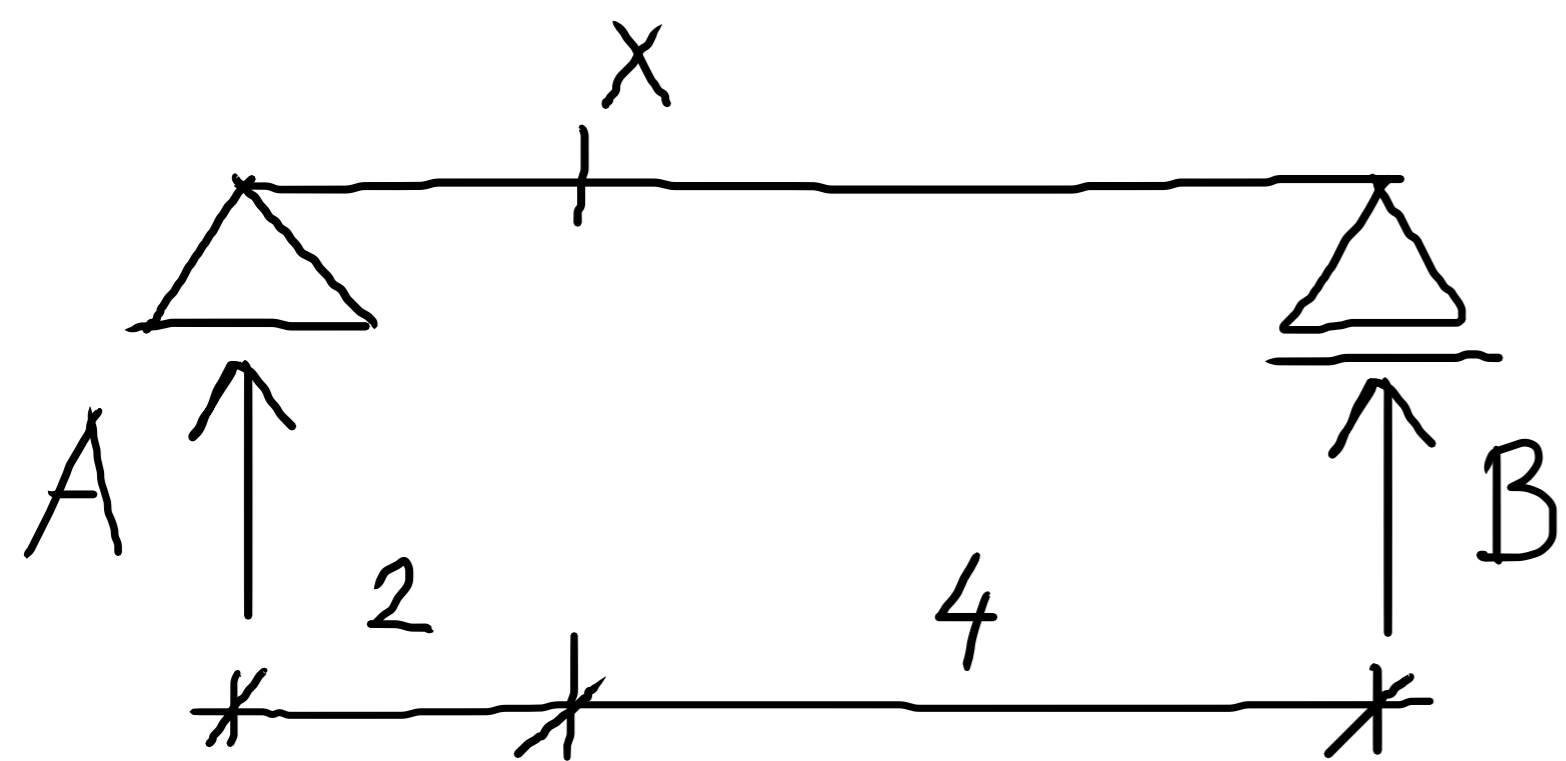

UMÍSTĚTE SPOJITÉ ZATÍŽENÍ DÉLKY 2m TAK, ŽE V MÍSTĚ X ZPŮSOBÍ MAXIMÁLNÍ OHYBOVÝ MOMENT.

M_x

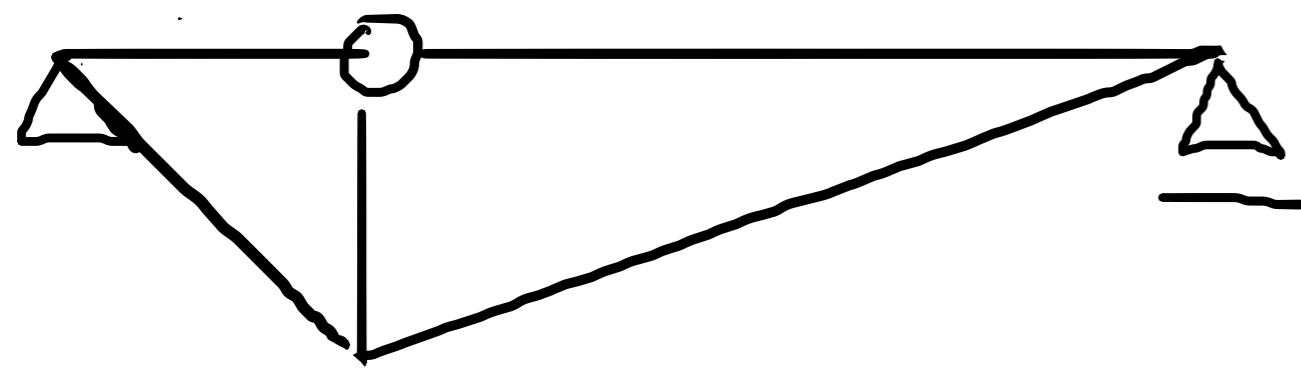

4/3

PŘÍČINKOVÉ ČÁRY - UMÍSTĚNÍ ZATÍŽENÍ

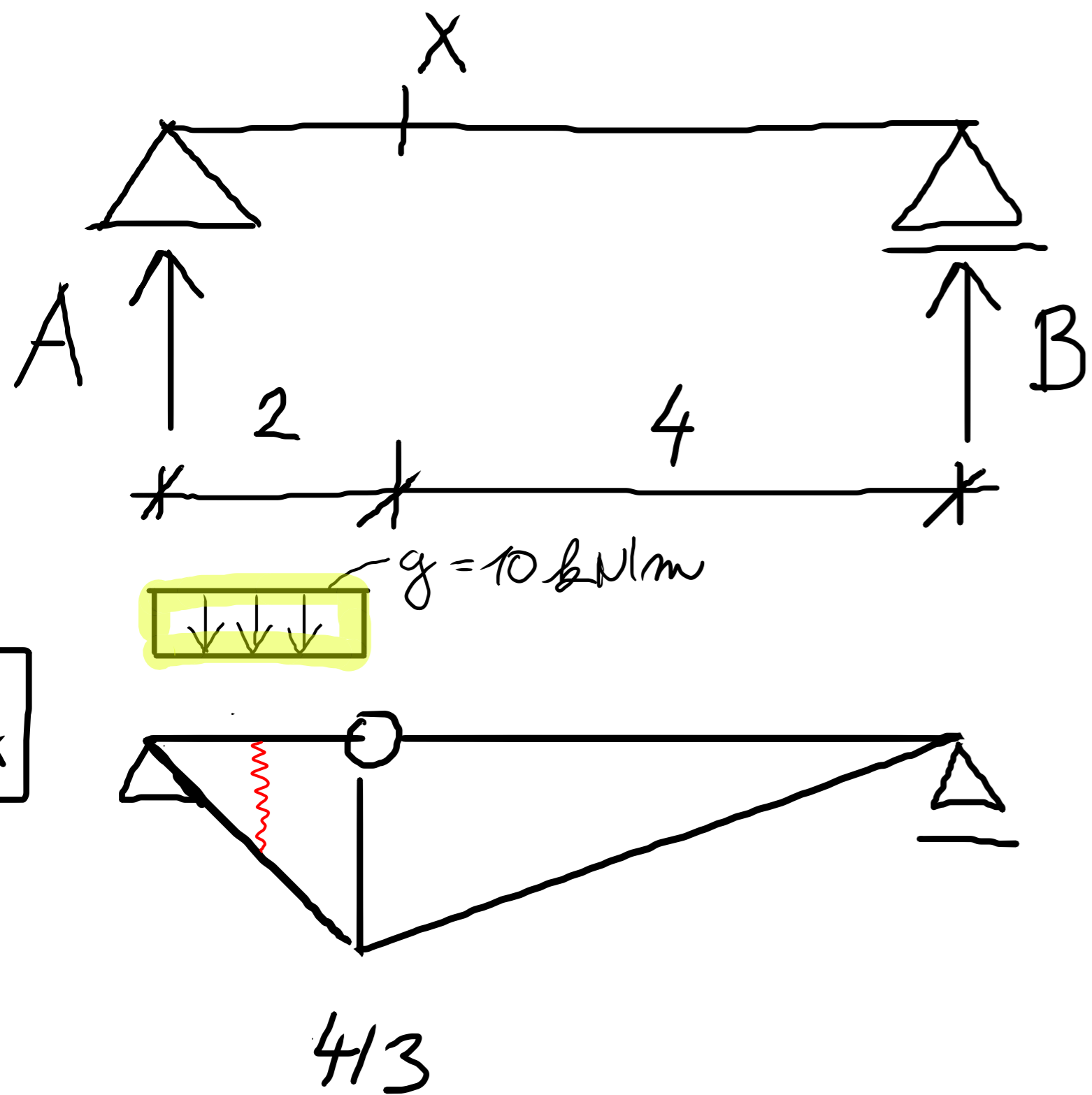

UMÍSTĚTE SPOJITÉ ZATÍŽENÍ DÉLKY 2m TAK, ŽE V MÍSTĚ X ZPŮSOBÍ MAXIMÁLNÍ OHYBOVÝ MOMENT.

$$\int_0^l g \cdot \eta dx \rightarrow \text{V.P.}$$

$$M_x = 10 \cdot 2 \cdot \frac{1}{2} \cdot \frac{4}{3} = 13,3 \text{ kNm}$$

PŘÍČINKOVÉ ČÁRY - UMÍSTĚNÍ ZATÍŽENÍ

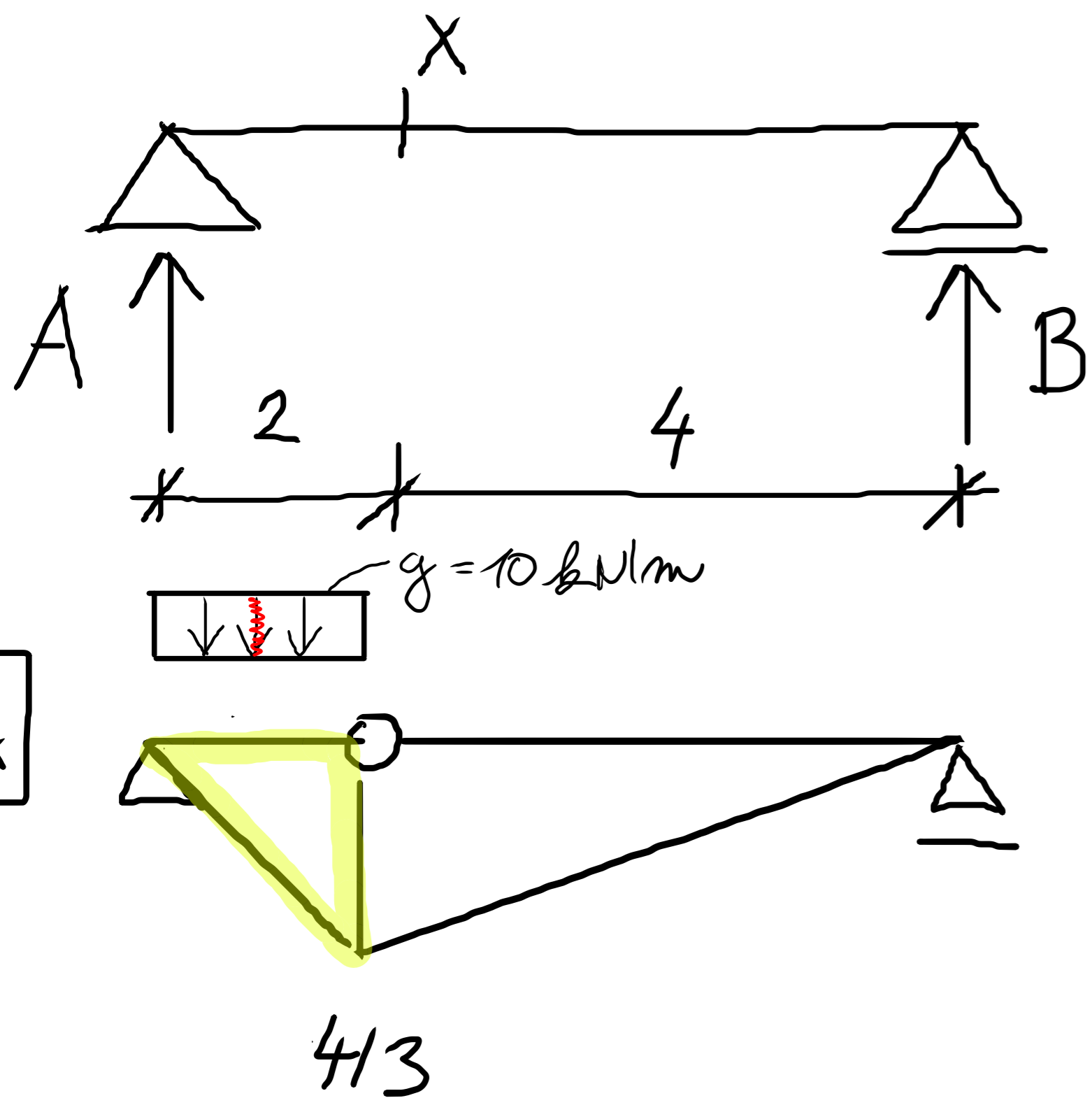

UMÍSTĚTE SPOJITÉ ZATÍŽENÍ DÉLKY 2m TAK, ŽE V MÍSTĚ X ZPŮSOBÍ MAXIMÁLNÍ OHYBOVÝ MOMENT.

$$\int_0^l g \cdot \eta dx \rightarrow \text{V.P.}$$

$$M_x = 10 \cdot 2 \cdot \frac{1}{2} \cdot \frac{4}{3} = 13,3 \text{ kNm}$$

$$M_x = \frac{1}{2} \cdot \frac{4}{3} \cdot 2 \cdot 10 = 13,3 \text{ kNm}$$

13,3 kNm

PŘÍČINKOVÉ ČÁRY - UMÍSTĚNÍ ZATÍŽENÍ

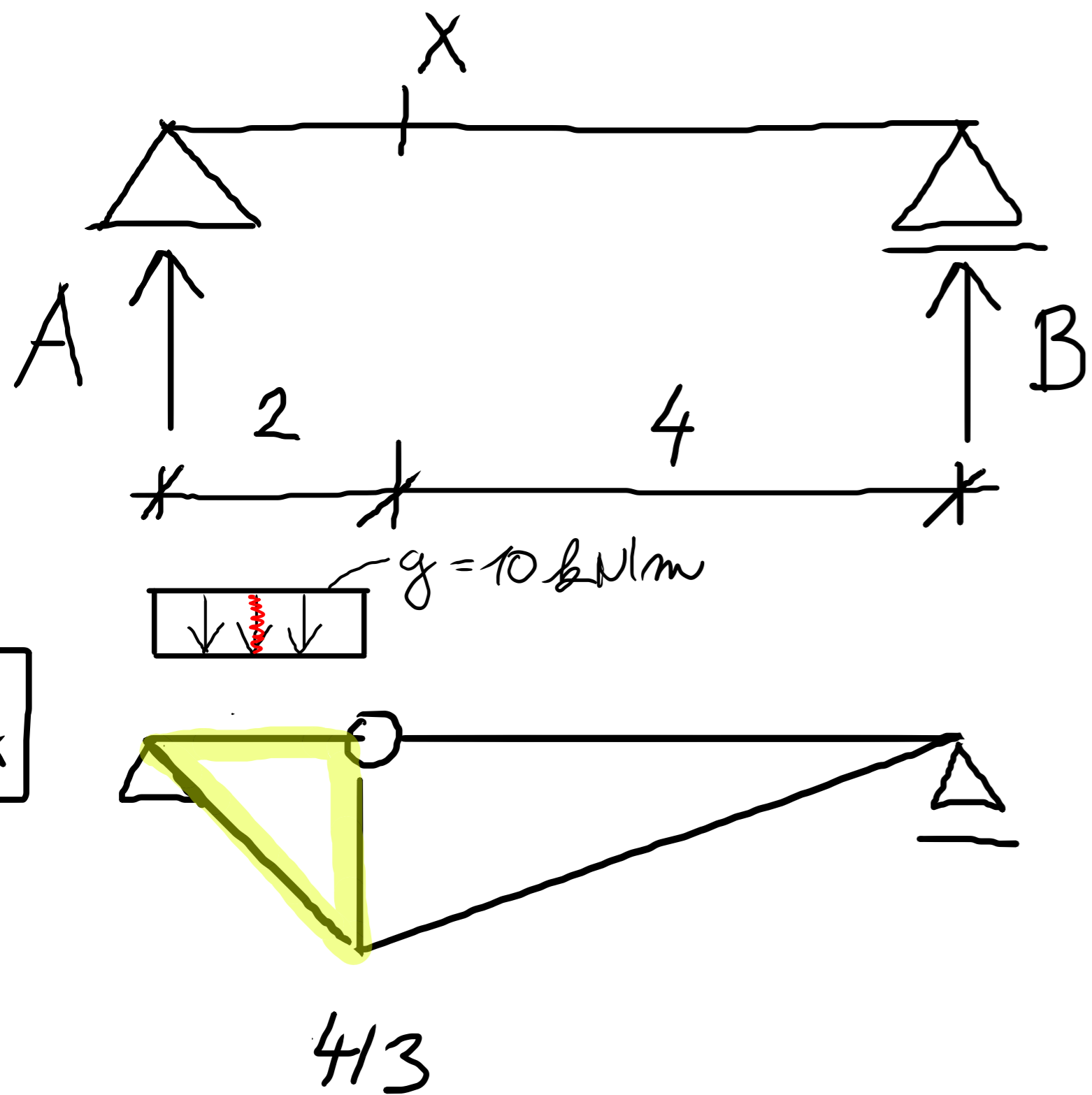

UMÍSTĚTE SPOJITÉ ZATÍŽENÍ DÉLKY 2m TAK, ŽE V MÍSTĚ X ZPŮSOBÍ MAXIMÁLNÍ OHYBOVÝ MOMENT.

MAXIMÁLNÍ MOMENT BUDE DOSAŽEN TEHDY, KDYŽ BUDE ŽLUTÁ PLOCHA MAXIMÁLNÍ.

PŘÍČINKOVÉ ČÁRY - UMÍSTĚNÍ ZATÍŽENÍ

UMÍSTĚTE SPOJITÉ ZATÍŽENÍ DÉLKY 2m TAK, ŽE V MÍSTĚ X ZPŮSOBÍ MAXIMÁLNÍ OHYBOVÝ MOMENT.

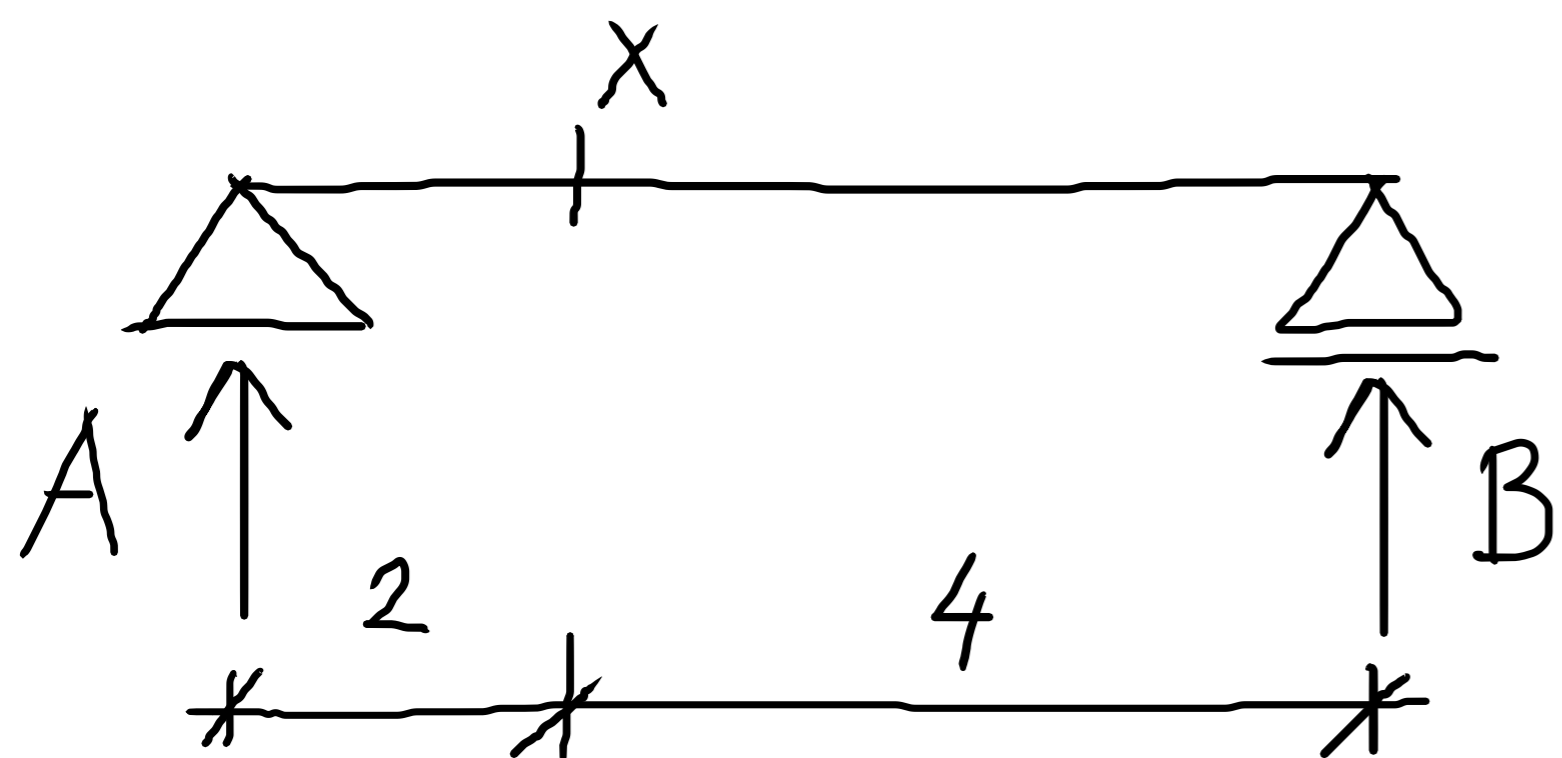

MAXIMÁLNÍ MOMENT BUDE DOSAŽEN TEHDY, KDYŽ BUDE ŽLUTÁ PLOCHA MAXIMÁLNÍ.

M_x

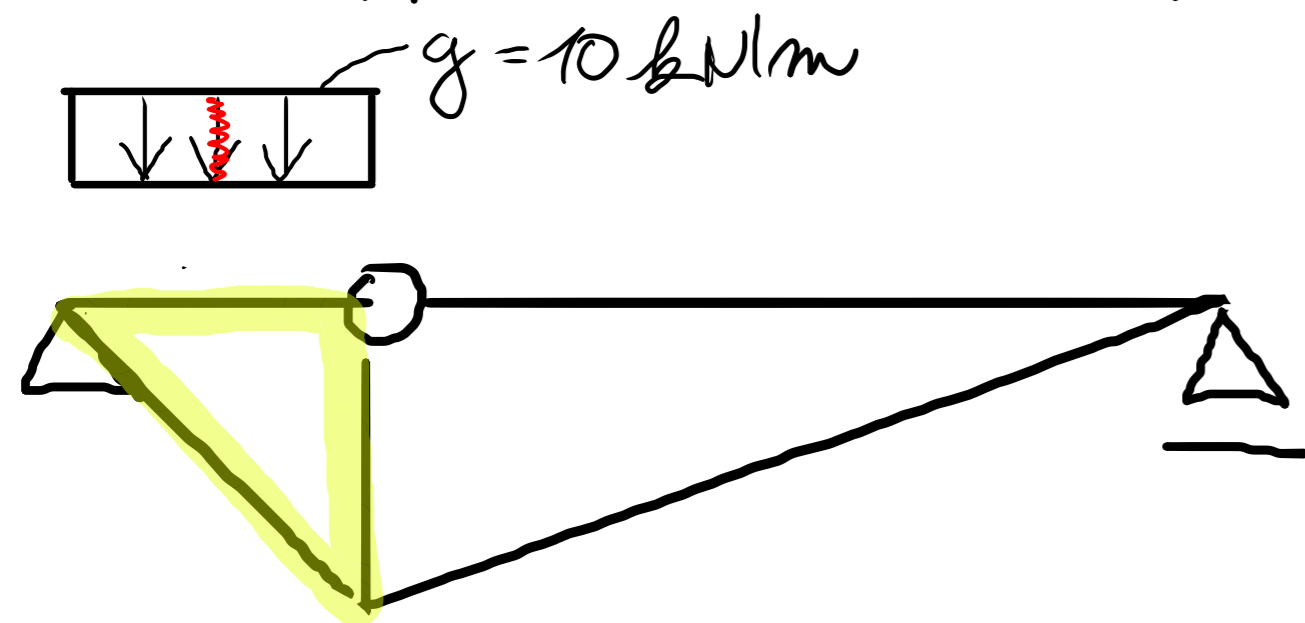

413

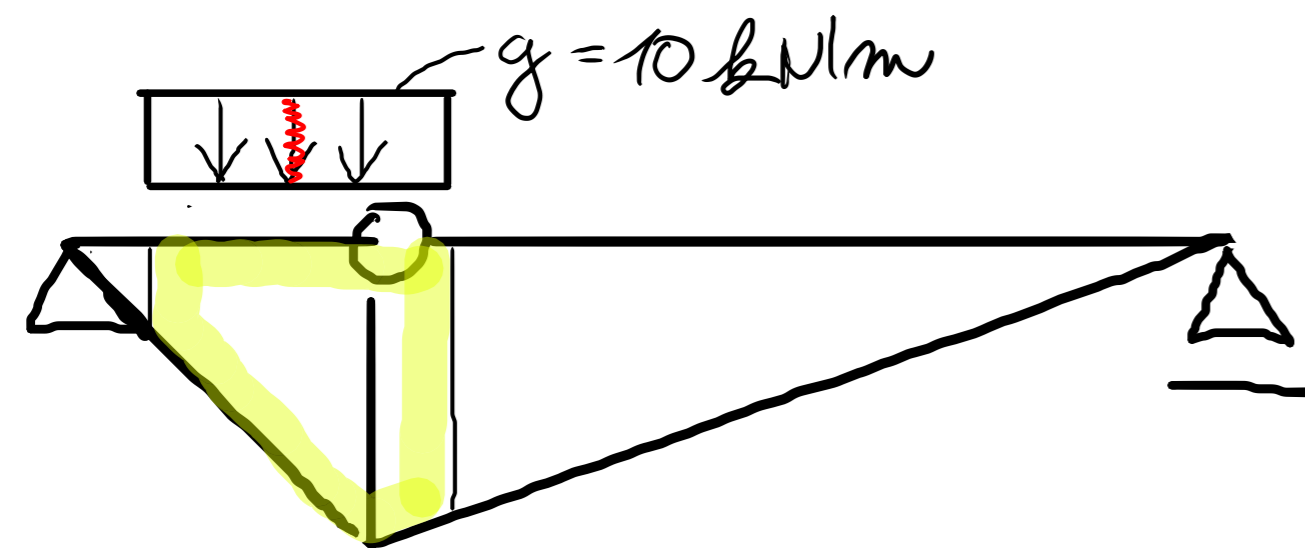

413

PŘÍČINKOVÉ ČÁRY - UMÍSTĚNÍ ZATÍŽENÍ

UMÍSTĚTE SPOJITÉ ZATÍŽENÍ DÉLKY 2m TAK, ŽE V MÍSTĚ X ZPŮSOBÍ MAXIMÁLNÍ OHYBOVÝ MOMENT.

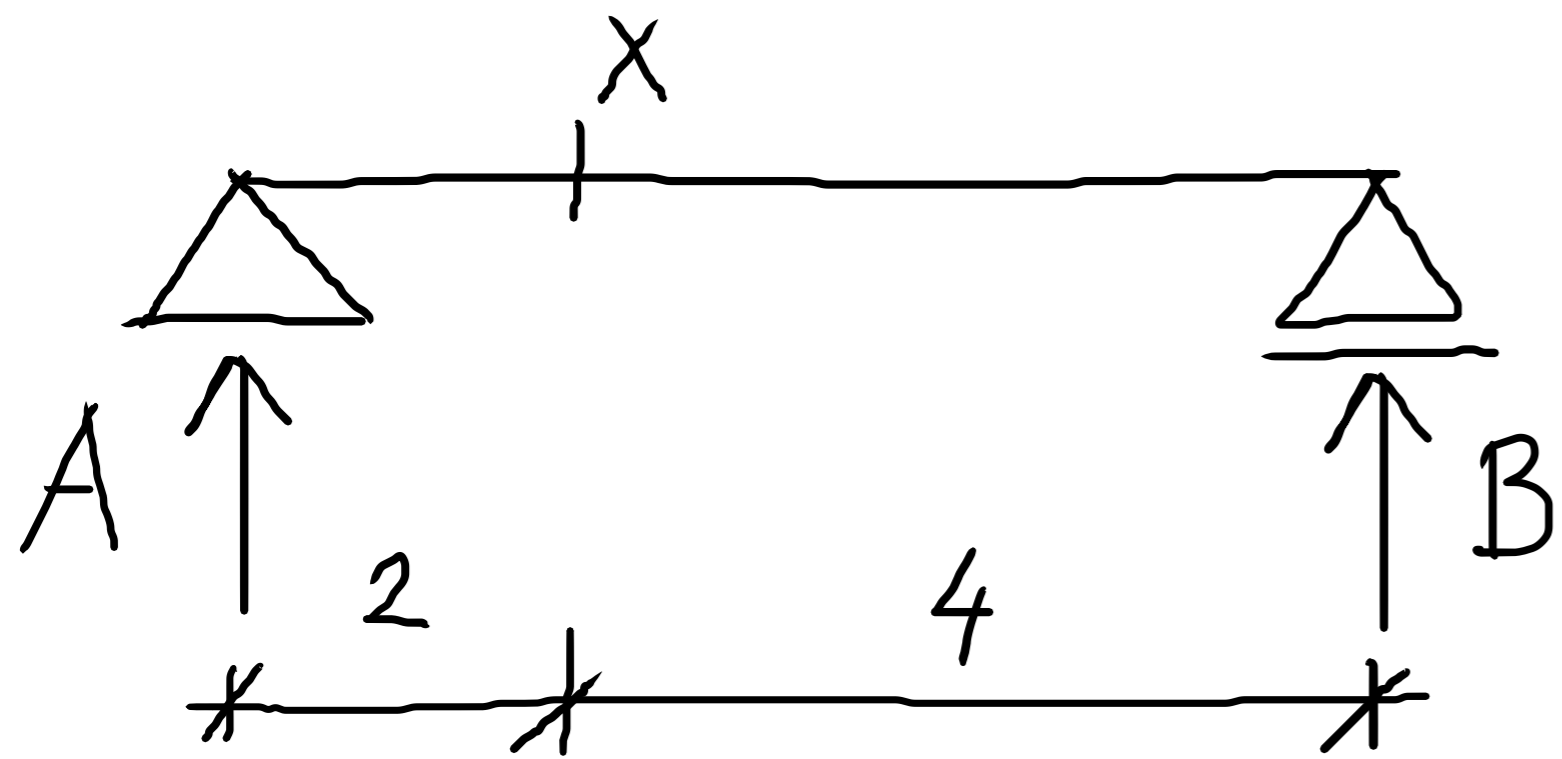

MAXIMÁLNÍ MOMENT BUDE DOSAŽEN TEHDY, KDYŽ BUDE ŽLUTÁ PLOCHA MAXIMÁLNÍ.

M_x

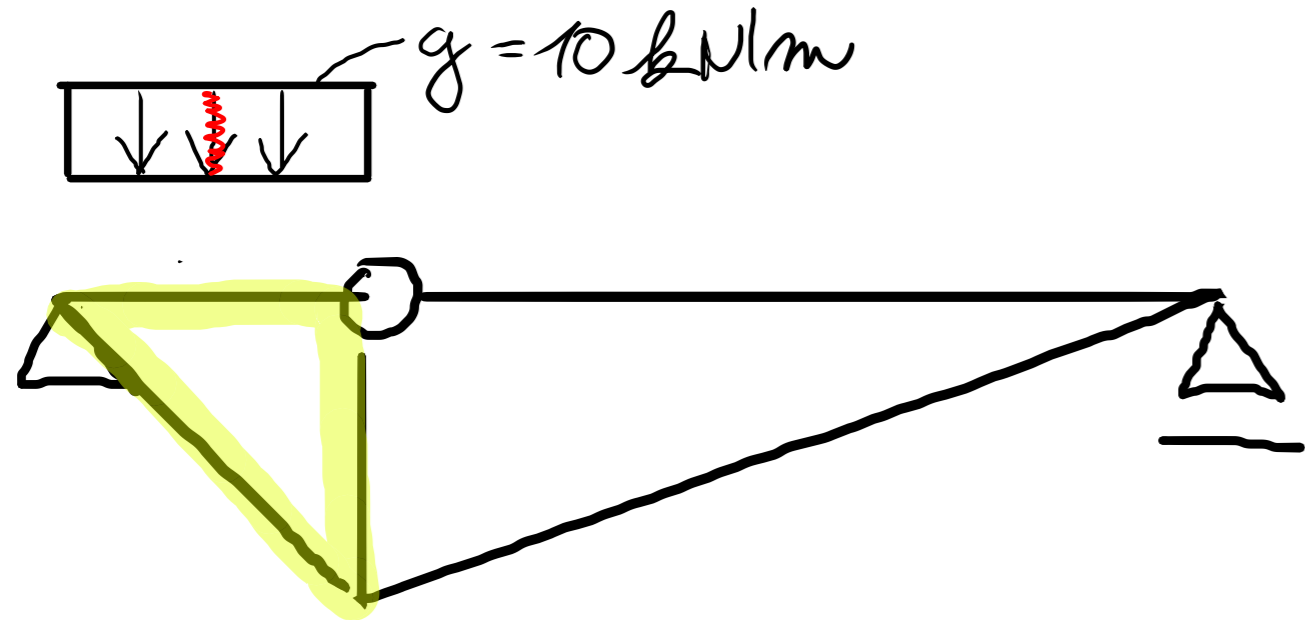

4/3

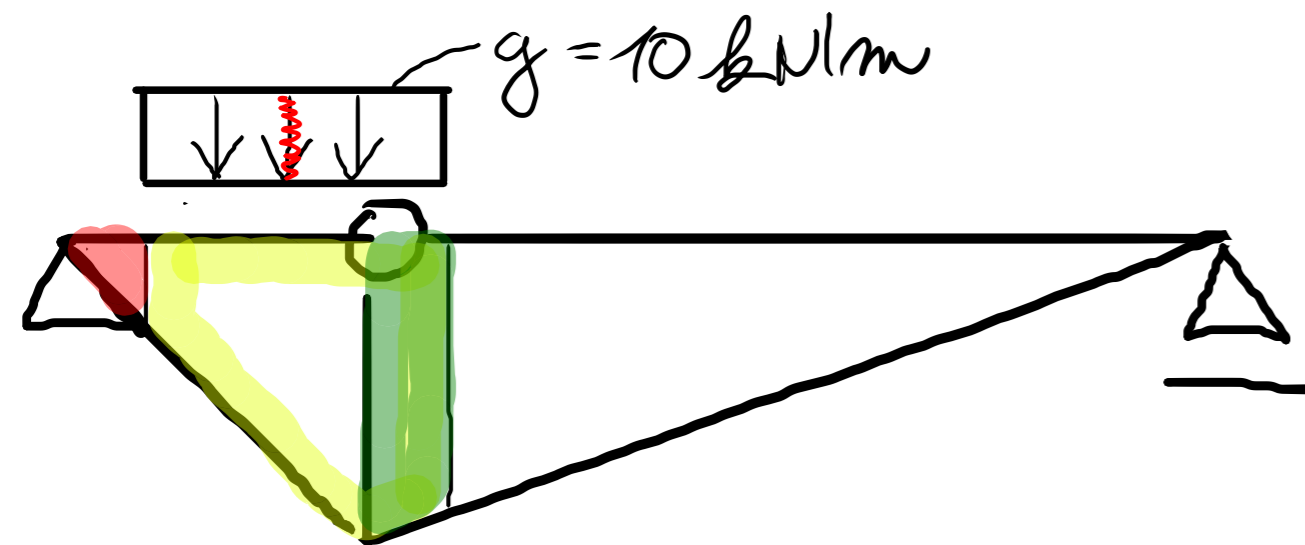

4/3

PŘÍČINKOVÉ ČÁRY - UMÍSTĚNÍ ZATÍŽENÍ

UMÍSTĚTE SPOJITÉ ZATÍŽENÍ DÉLKY 2m TAK, ŽE V MÍSTĚ X ZPŮSOBI MAXIMÁLNÍ OHYBOVÝ MOMENT.

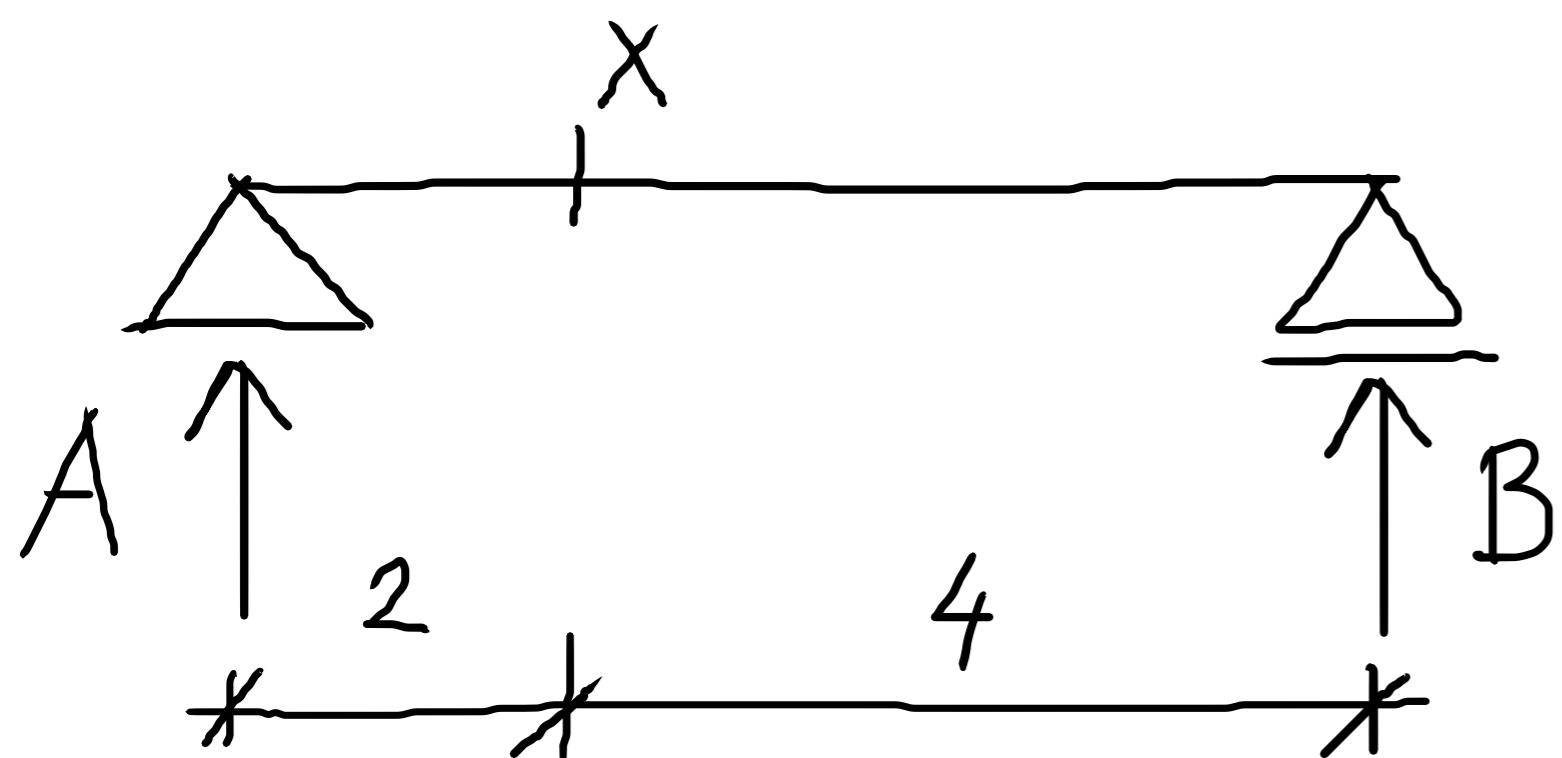

MAXIMÁLNÍ MOMENT BUDE DOSAŽEN TEHDY, KDYŽ BUDE ŽLUTÁ PLOCHA MAXIMÁLNÍ.

M_x

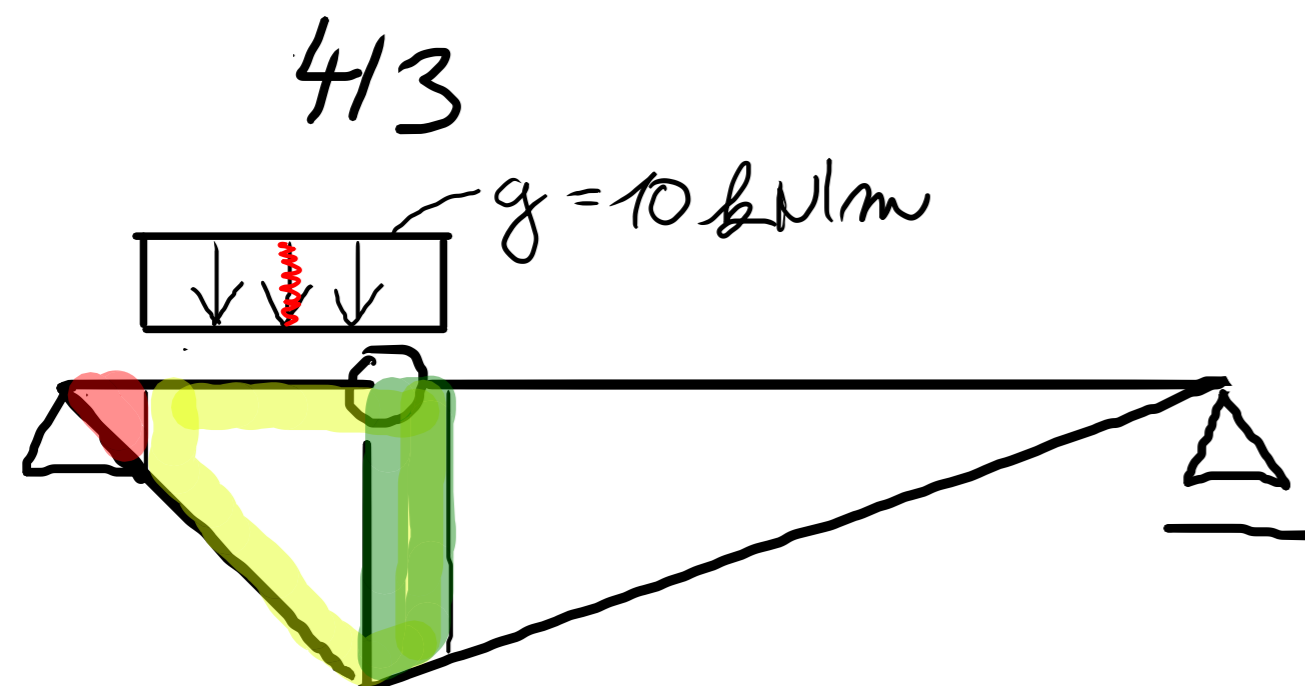
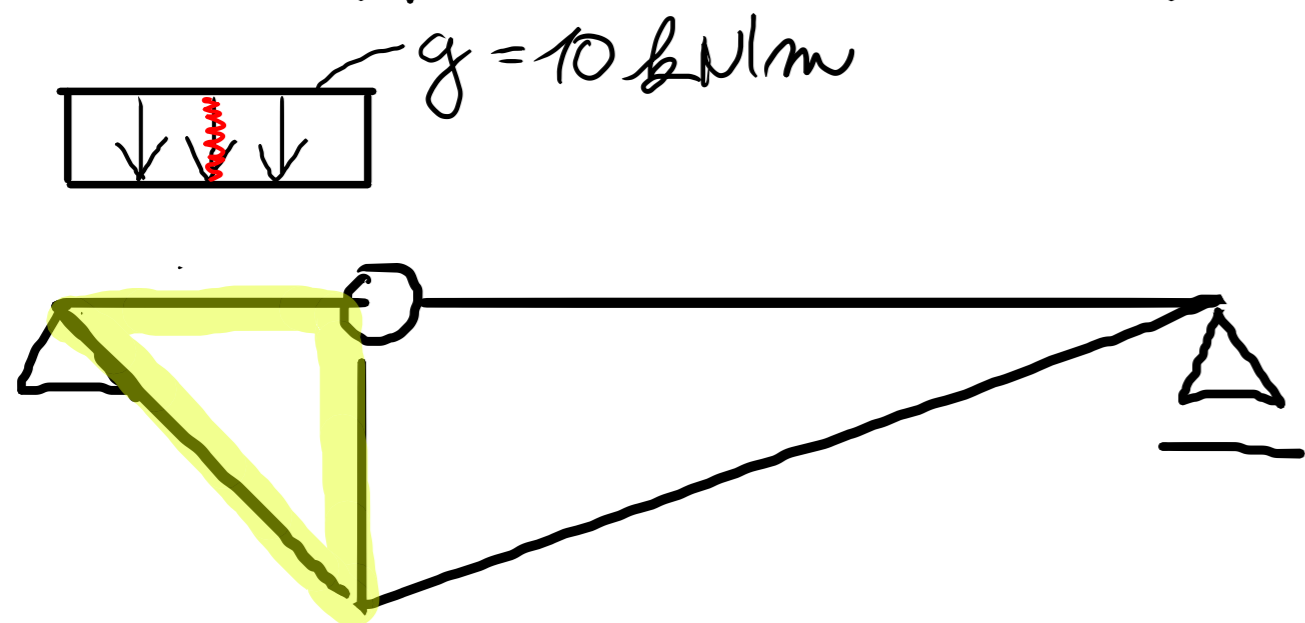

● ZTRÁTA } \Rightarrow DRUHÁ POLOHA ZATÍŽENÍ ZPŮSOBÍ VĚTŠÍ OHYBOVÝ MOMENT
● ZISK

PŘÍČINKOVÉ ČÁRY - UMÍSTĚNÍ ZATIŽENÍ

UMÍSTĚTE SPOJITÉ ZATIŽENÍ DÉLKY 2m TAK, ŽE V MÍSTĚ X ZPŮSOBI MAXIMÁLNÍ OHYBOVÝ MOMENT.

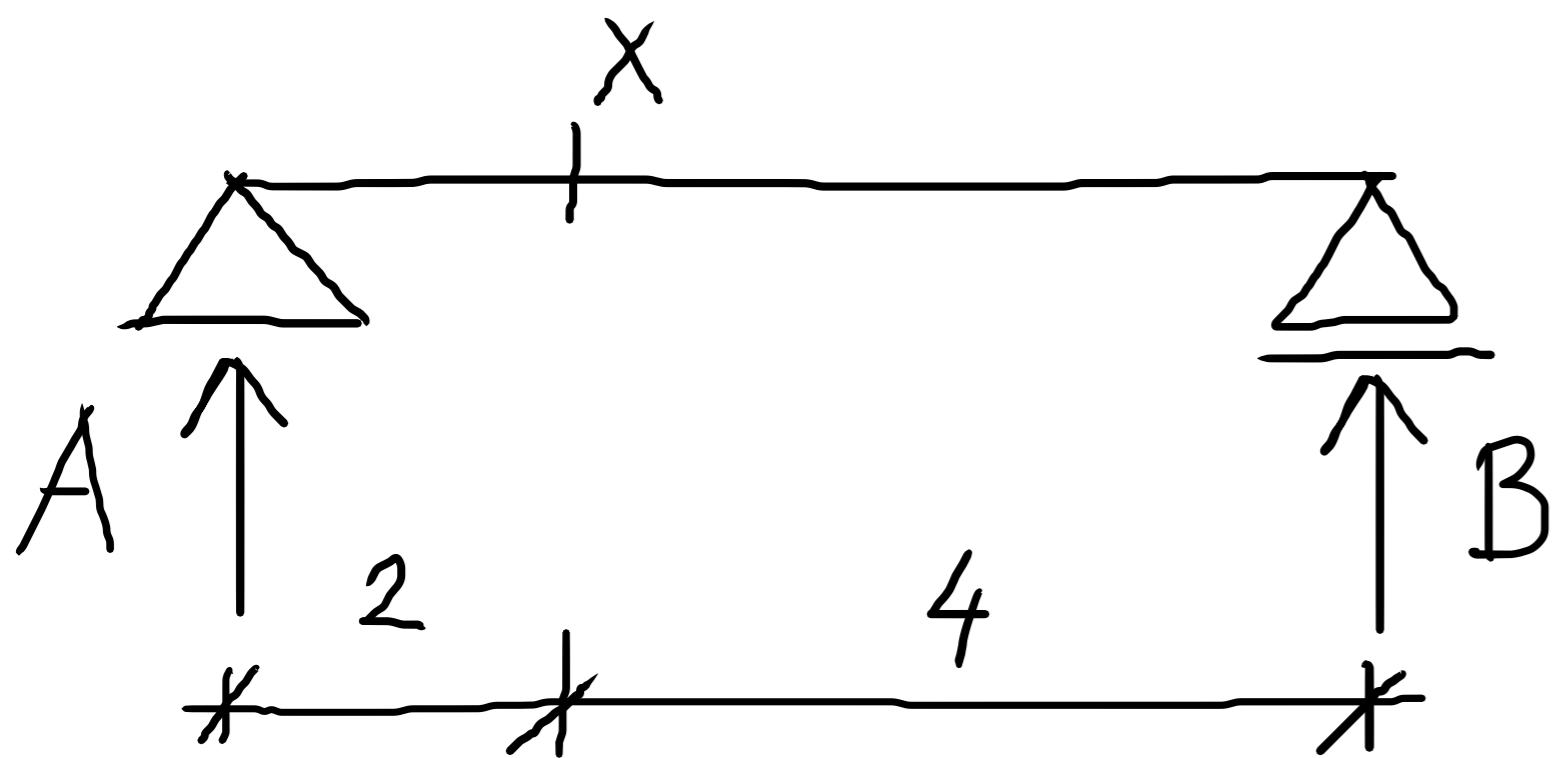

MAXIMÁLNÍ MOMENT BUDE DOSAŽEN TEHDY, KDYŽ BUDE ŽLUTÁ PLOCHA MAXIMÁLNÍ.

M_x

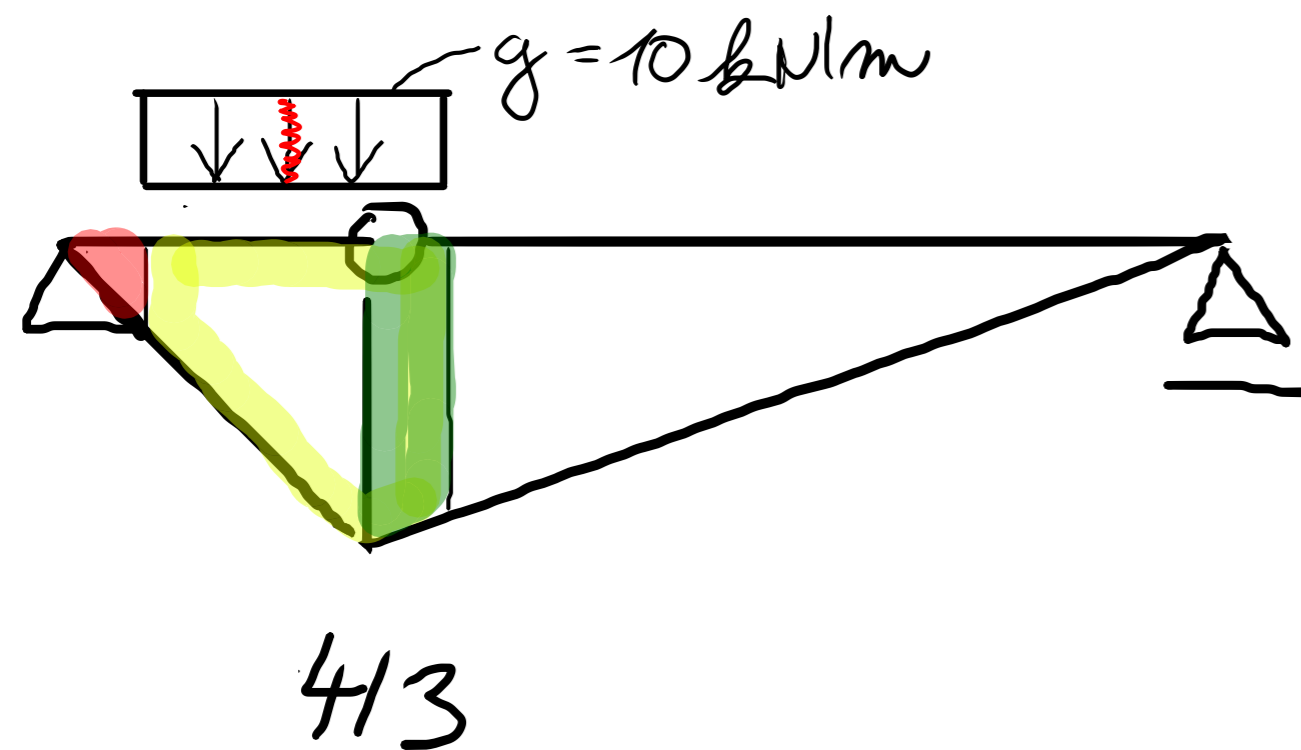
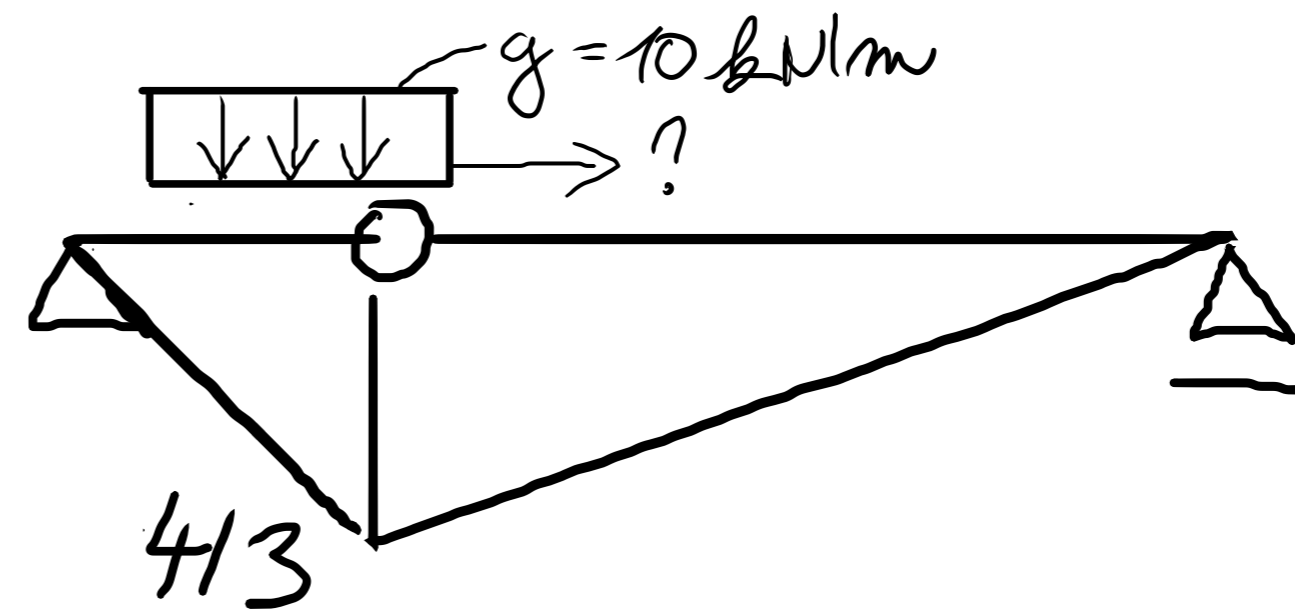
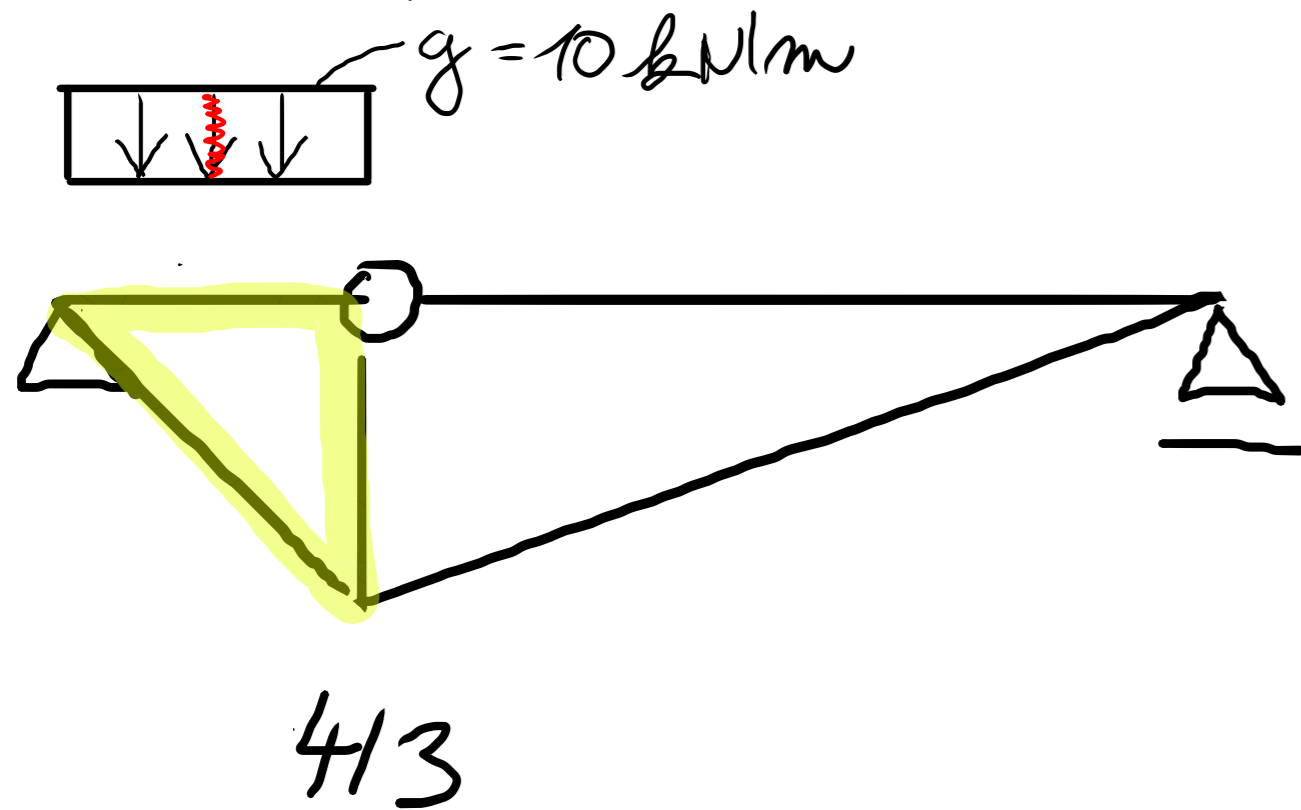

JAK DALEKO MÁM ZATIŽENÍ POSOUVAT?
DOKUD NEZAČNU ZTRÁČET.

PŘÍČINKOVÉ ČÁRY - UMIŠTĚNÍ ZATIŽENÍ

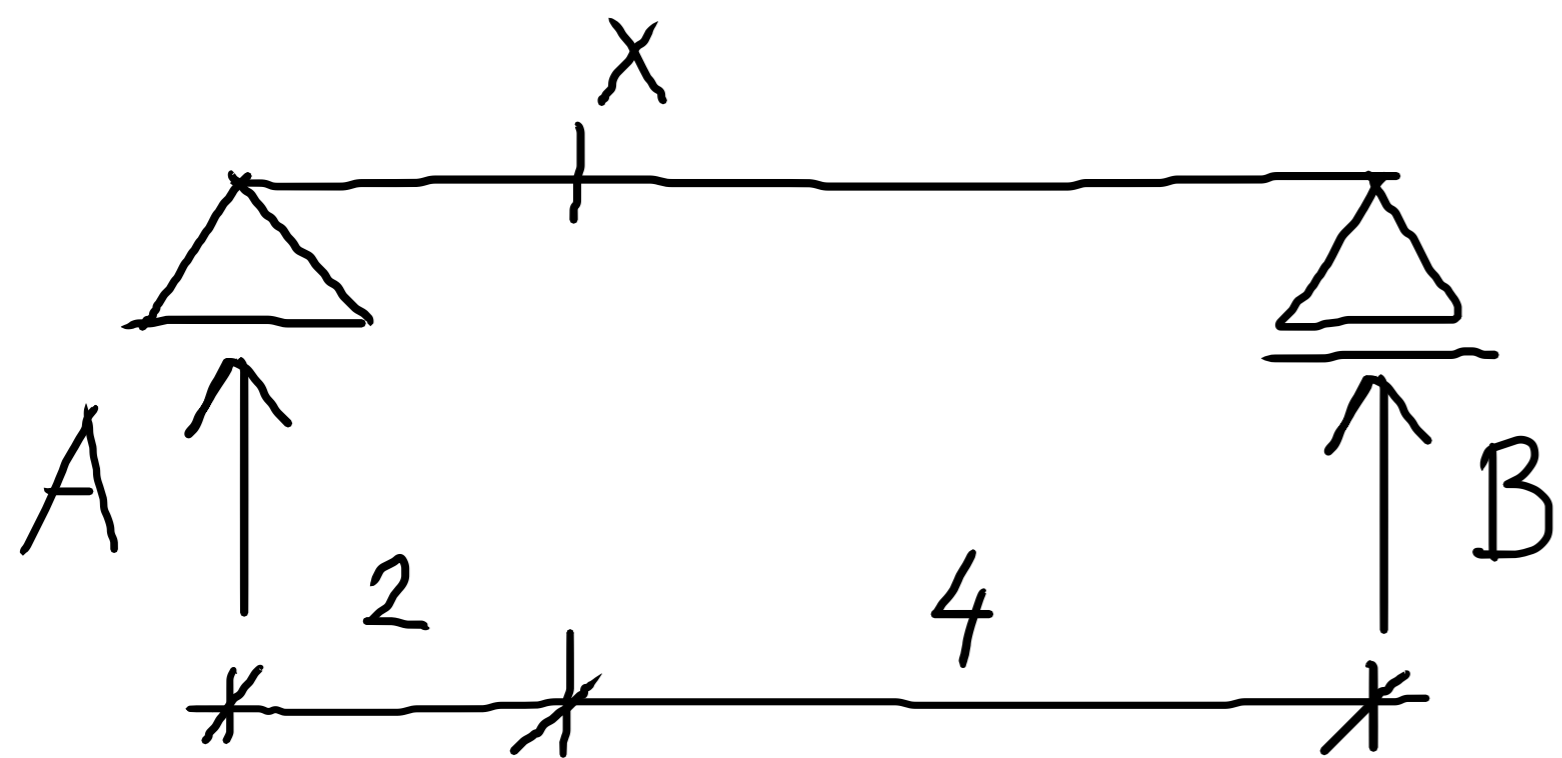

UMIŠTĚTE SPOJITÉ ZATIŽENÍ DÉLKY 2m TAK, ŽE V MÍSTĚ X ZPŮSOBÍ MAXIMÁLNÍ OHYBOVÝ MOMENT.

MAXIMÁLNÍ MOMENT BUDE DOSAŽEN TEHDY, KDYŽ BUDE ŽLUTÁ PLOCHA MAXIMÁLNÍ.

M_x

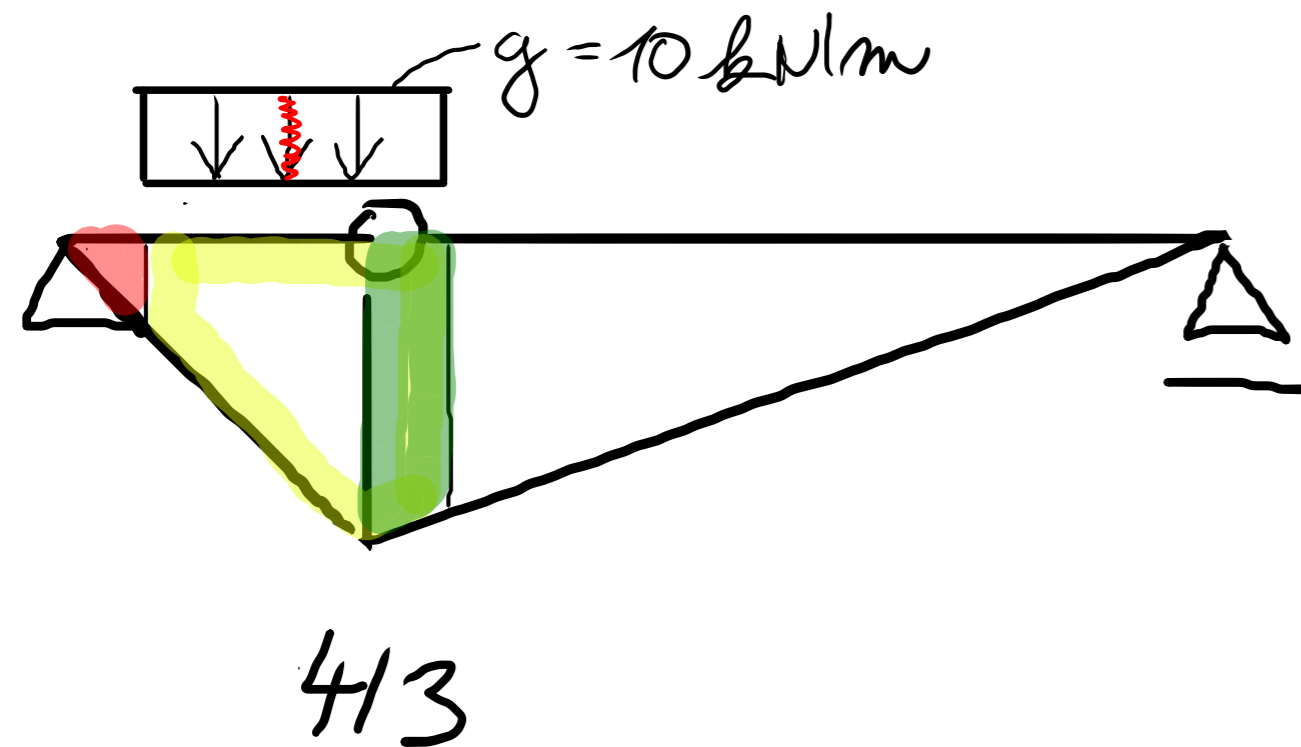
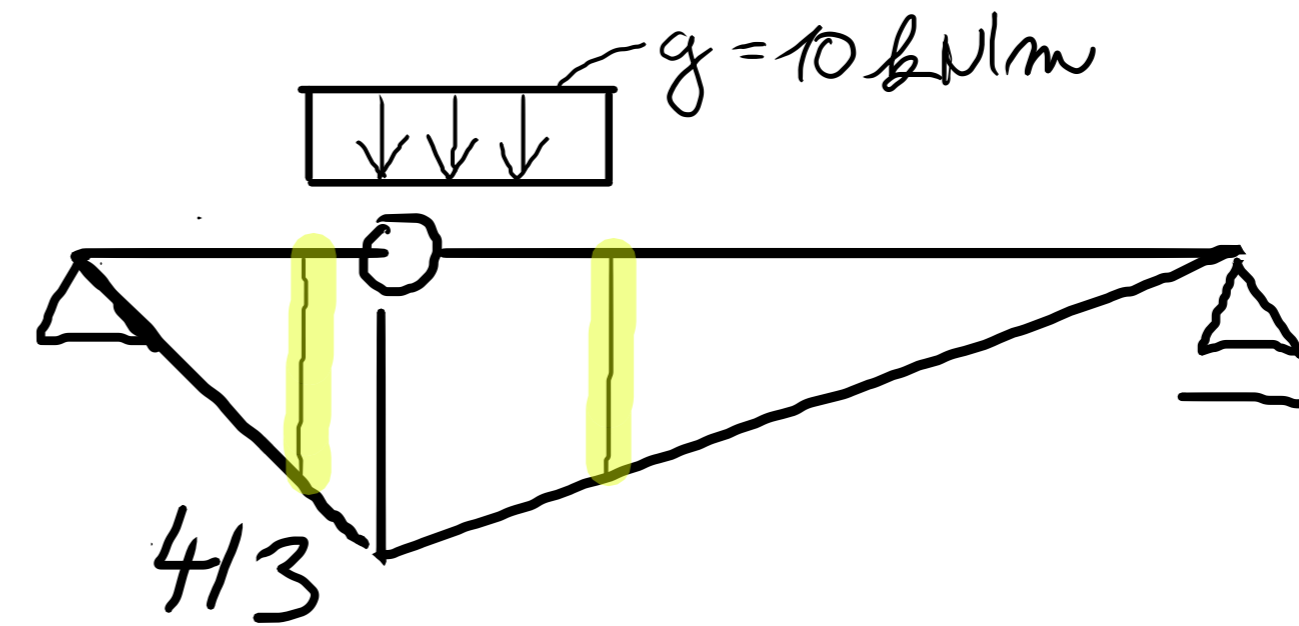
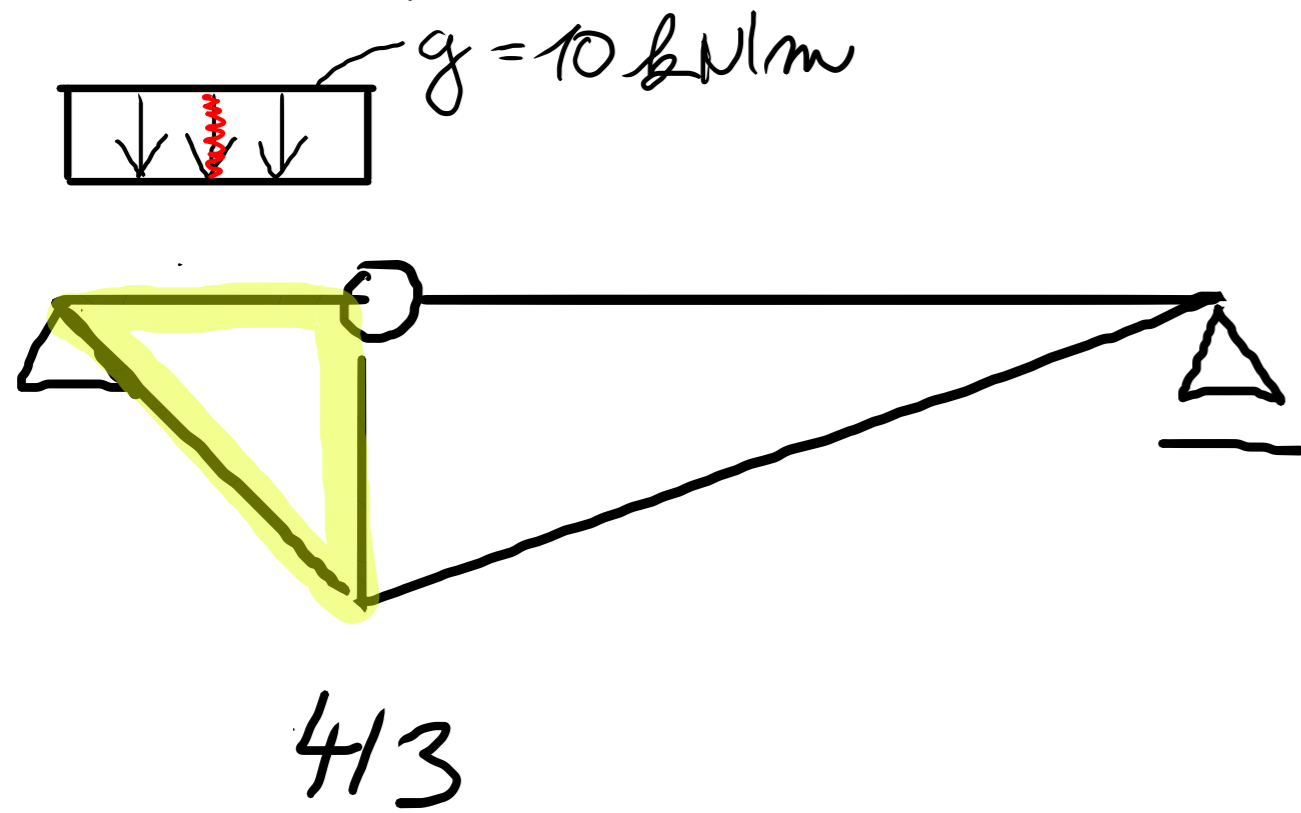

JAK DALEKO MÁM ZATIŽENÍ POSOUVAT?
DOKUD NEZAČNU ZTRÁČET.

PŘÍČINKOVÉ ČÁRY - UMÍSTĚNÍ ZATÍŽENÍ

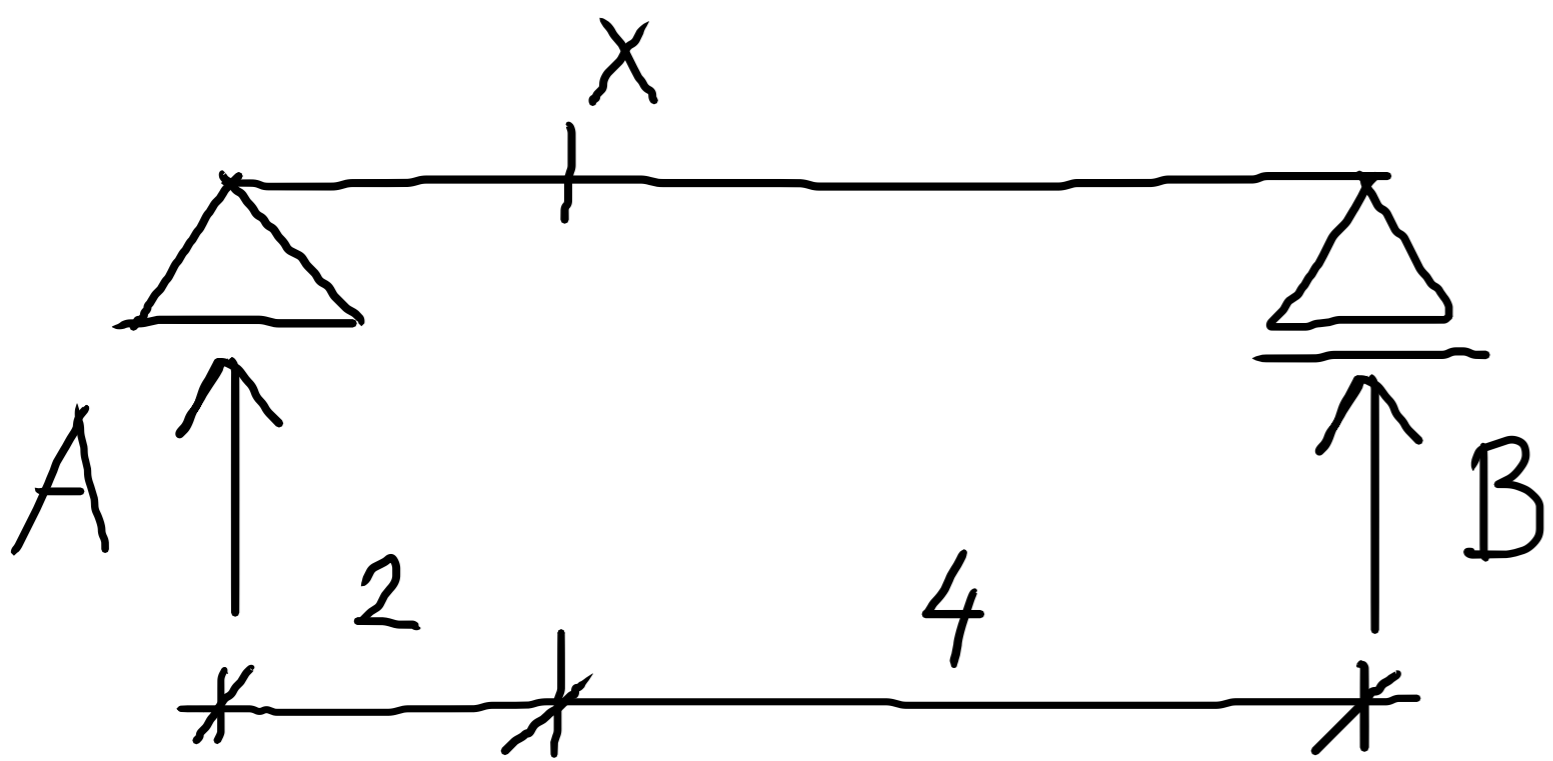

UMÍSTĚTE SPOJITÉ ZATÍŽENÍ DÉLKY 2m TAK, ŽE V MÍSTĚ X ZPŮSOBÍ MAXIMÁLNÍ OHYBOVÝ MOMENT.

M_x

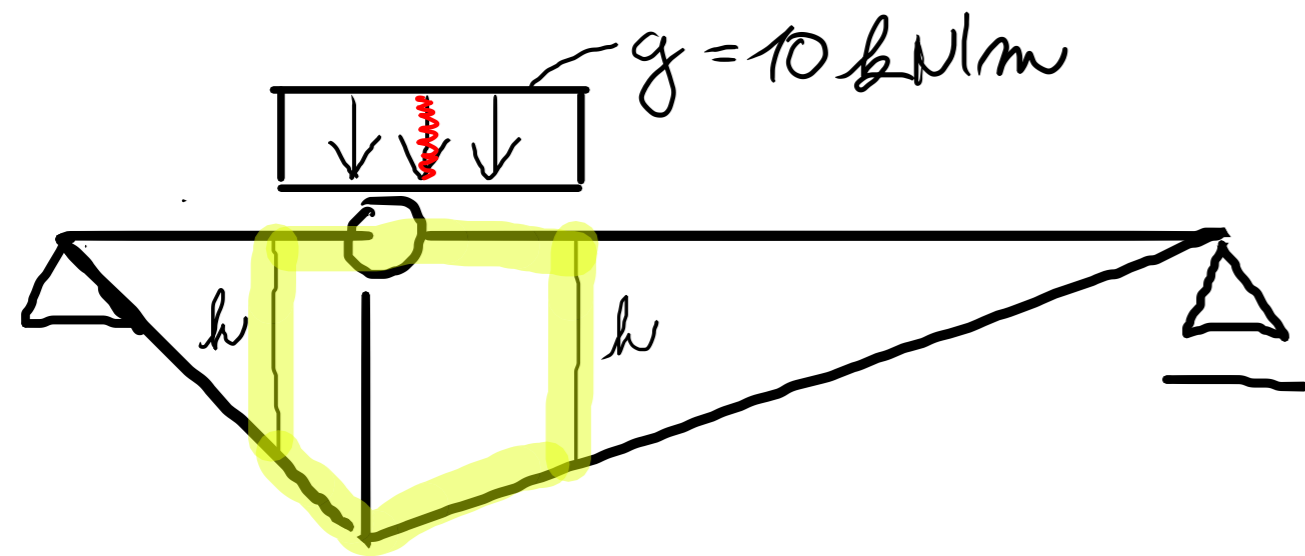

413

PŘÍČINKOVÉ ČÁRY - UMÍSTĚNÍ ZATÍŽENÍ

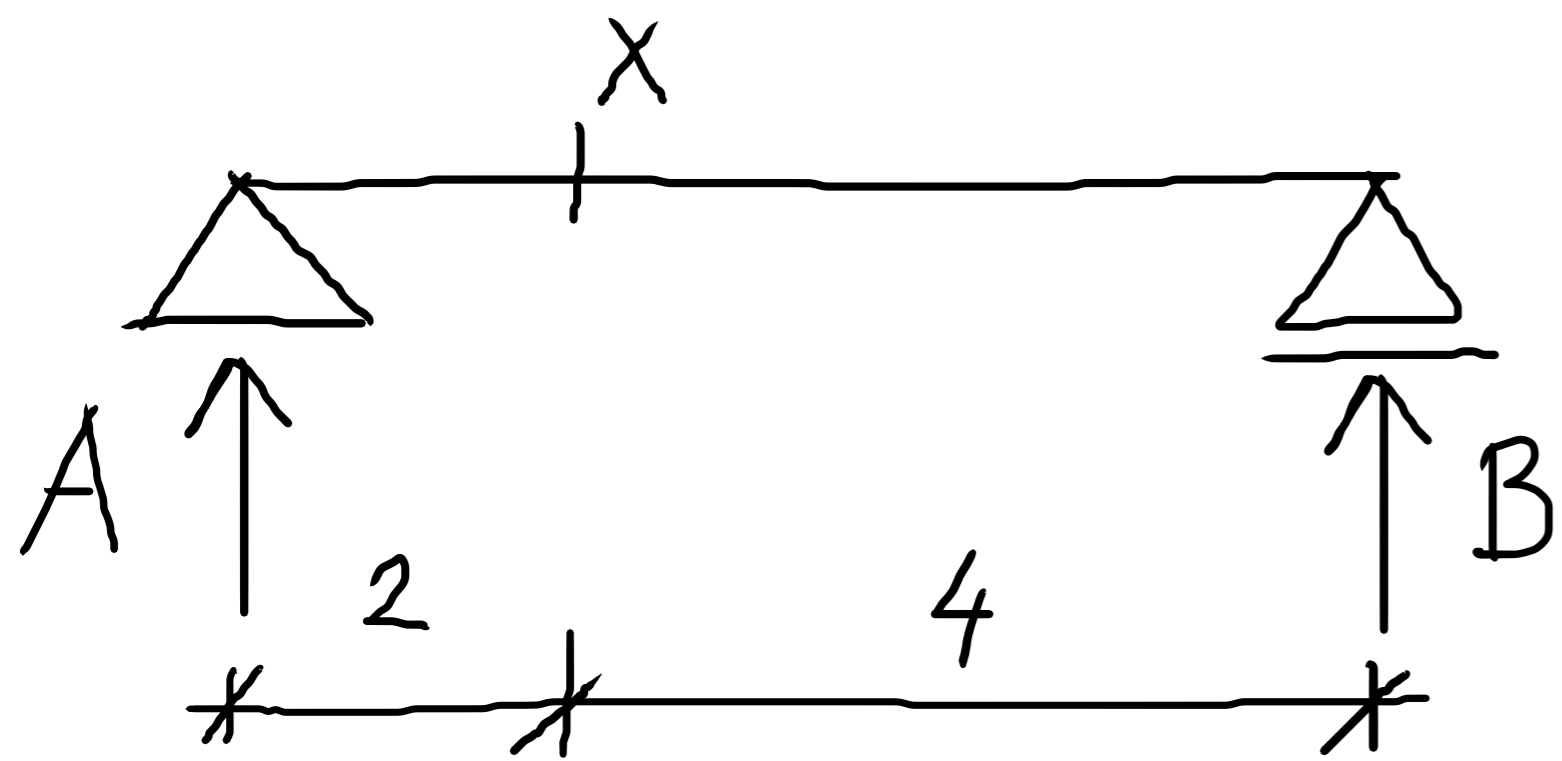

UMÍSTĚTE SPOJITÉ ZATÍŽENÍ DÉLKY 2m TAK, ŽE V MÍSTĚ X ZPŮSOBÍ MAXIMÁLNÍ OHYBOVÝ MOMENT.

1) VÝPOČET Z PŘEDPISU FUNKCE

M_x

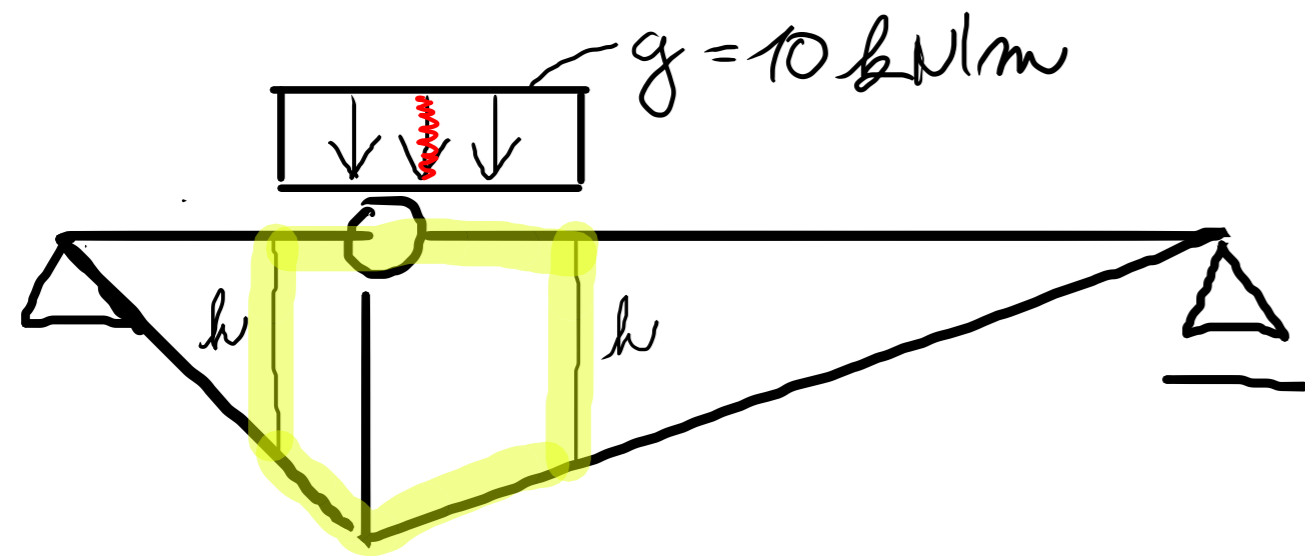

413

PŘÍČINKOVÉ ČÁRY - UMÍSTĚNÍ ZATÍŽENÍ

UMÍSTĚTE SPOJITÉ ZATÍŽENÍ DÉLKY 2m TAK, ŽE V MÍSTĚ X ZPŮSOBÍ MAXIMÁLNÍ OHYBOVÝ MOMENT.

1) VÝPOČET Z PŘEDPISU FUNKCE

$$x_1 = \frac{2}{3}x$$

M_x

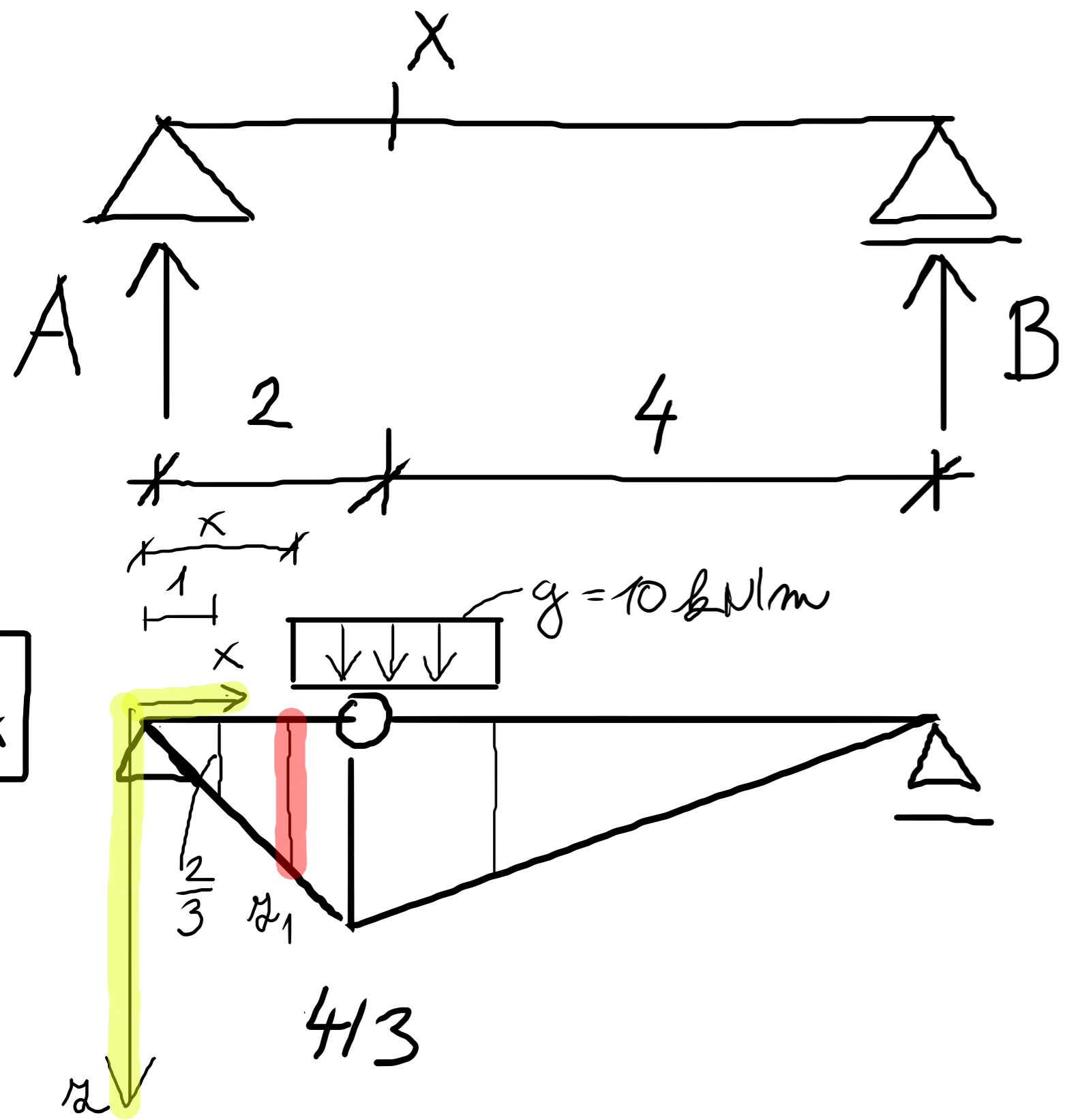

PŘÍČINKOVÉ ČÁRY - UMÍSTĚNÍ ZATÍŽENÍ

UMÍSTĚTE SPOJITÉ ZATÍŽENÍ DÉLKY 2m TAK, ŽE V MÍSTĚ X ZPŮSOBI MAXIMÁLNÍ OHYBOVÝ MOMENT.

1) VÝPOČET Z PŘEDPISU FUNKCE

$$R_1 = \frac{2}{3}x \quad ; \quad R_2 = 2 - \frac{1}{3}(x+2)$$

M_x

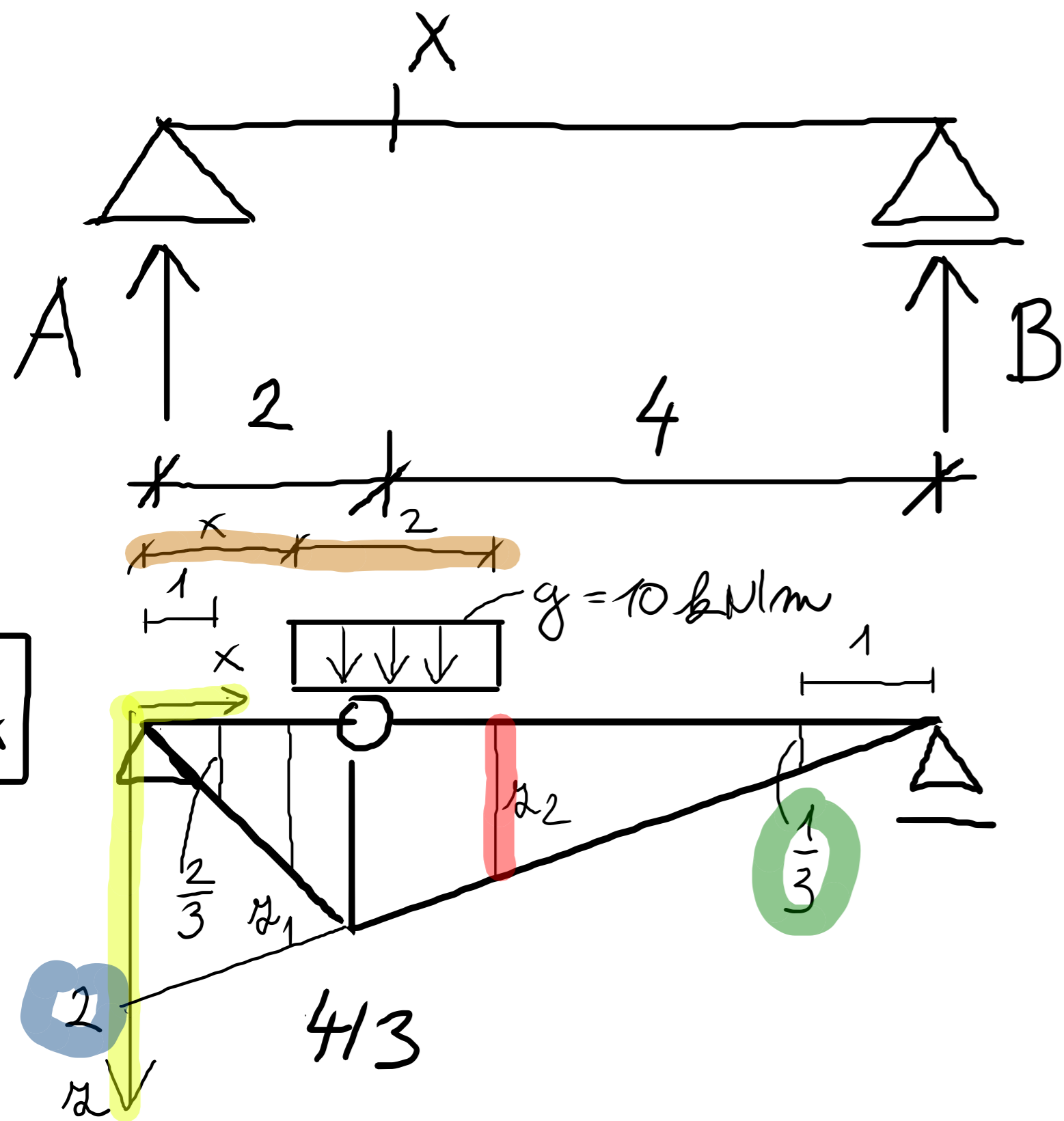

PŘÍČINKOVÉ ČÁRY - UMÍSTĚNÍ ZATÍŽENÍ

UMÍSTĚTE SPOJITÉ ZATÍŽENÍ DÉLKY 2m TAK, ŽE V MÍSTĚ X ZPŮSOBÍ MAXIMÁLNÍ OHYBOVÝ MOMENT.

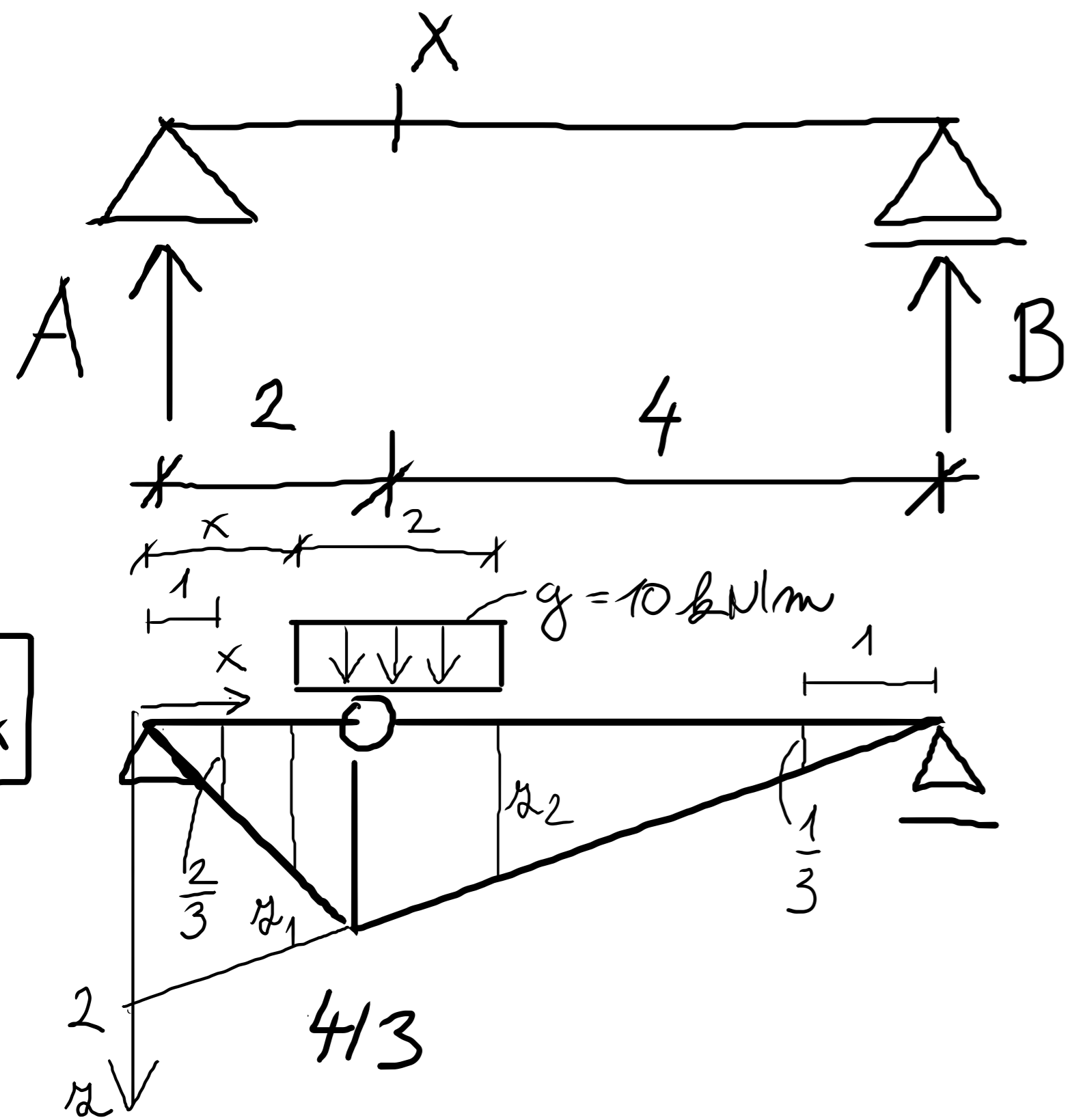

1) VÝPOČET Z PŘEDPISU FUNKCE

$$R_1 = \frac{2}{3}x \quad ; \quad R_2 = 2 - \frac{1}{3}(x+2)$$

$$R_1 = R_2$$

$$\frac{2}{3}x = 2 - \frac{1}{3}(x+2) \Rightarrow x = 1,3$$

PŘÍČINKOVÉ ČÁRY - UMÍSTĚNÍ ZATÍŽENÍ

UMÍSTĚTE SPOJITÉ ZATÍŽENÍ DÉLKY 2m TAK, ŽE V MÍSTĚ X ZPŮSOBÍ MAXIMÁLNÍ OHYBOVÝ MOMENT.

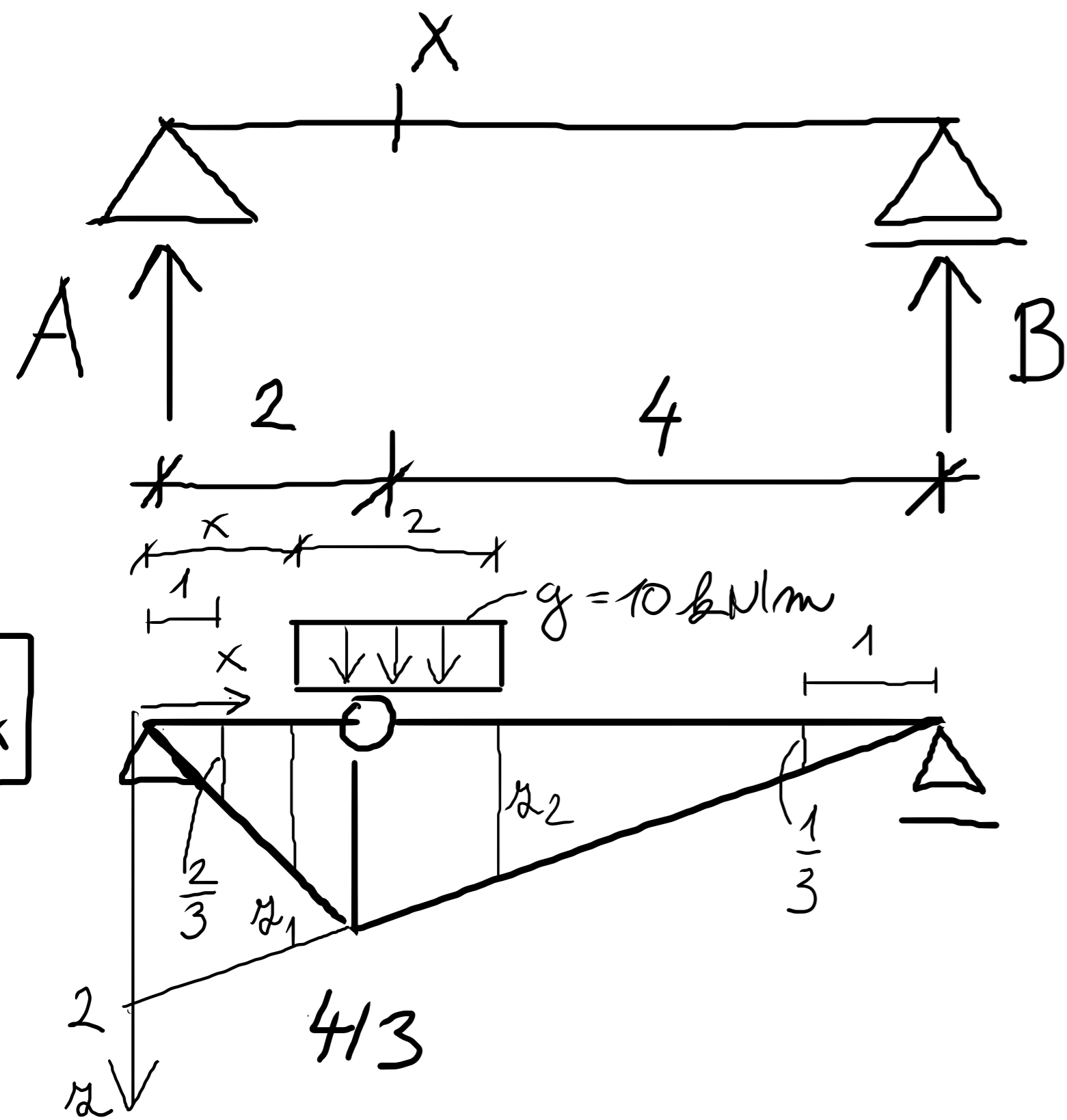

1) VÝPOČET Z PŘEDPISU FUNKCE

$$R_1 = \frac{2}{3}x \quad ; \quad R_2 = 2 - \frac{1}{3}(x+2)$$

$$R_1 = R_2$$

$$\frac{2}{3}x = 2 - \frac{1}{3}(x+2) \Rightarrow x = 1,3 \quad ; \quad R_1 = R_2 = \frac{2}{3} \cdot 1,3 = 0,8$$

PŘÍČINKOVÉ ČÁRY - UMÍSTĚNÍ ZATÍŽENÍ

UMÍSTĚTE SPOJITÉ ZATÍŽENÍ DÉLKY 2m TAK, ŽE V MÍSTĚ X ZPŮSOBÍ MAXIMÁLNÍ OHYBOVÝ MOMENT.

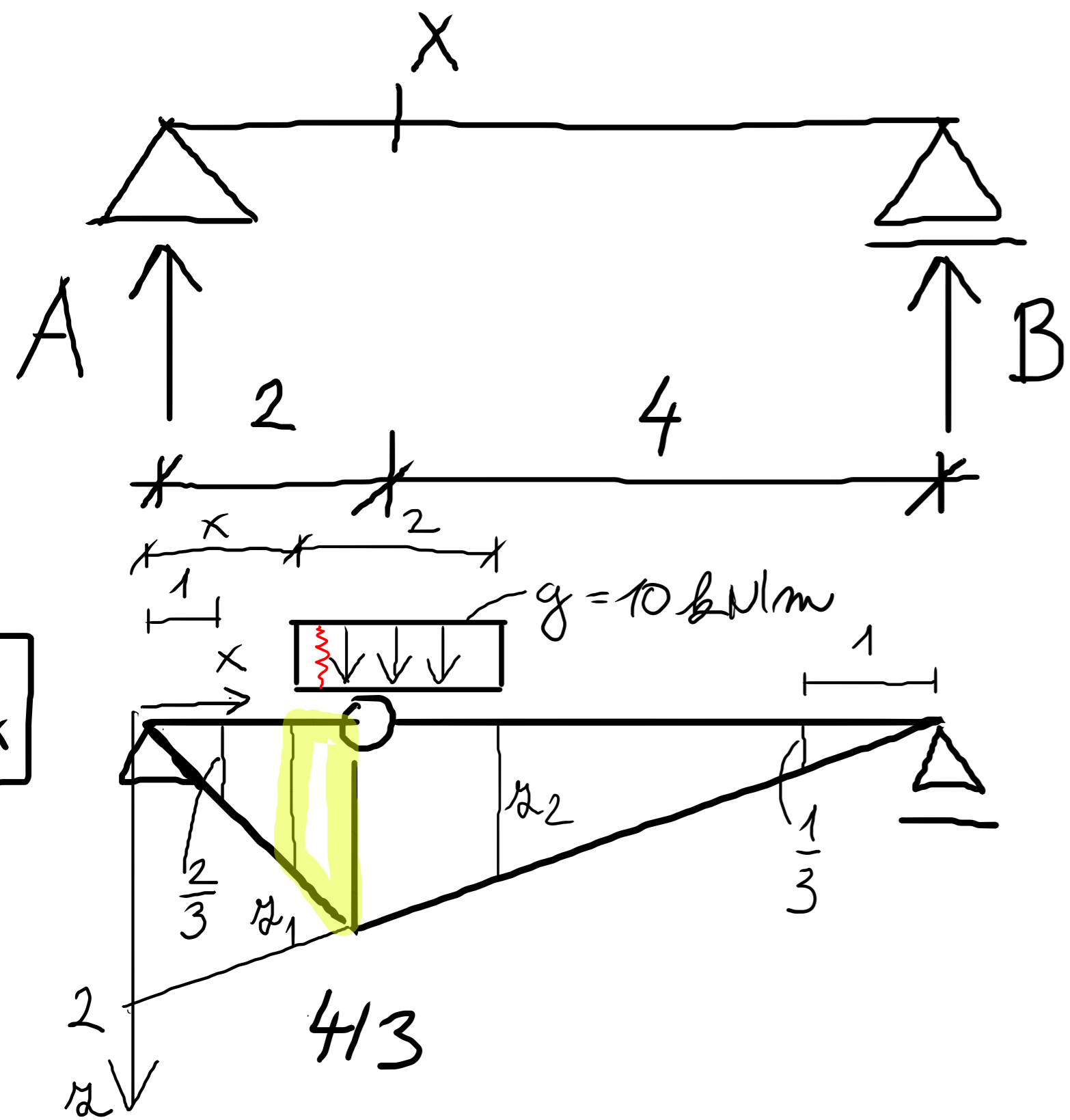

1) VÝPOČET Z PŘEDPISU FUNKCE

$$a_1 = \frac{2}{3}x \quad ; \quad a_2 = 2 - \frac{1}{3}(x+2)$$

$$a_1 = a_2$$

$$\frac{2}{3}x = 2 - \frac{1}{3}(x+2) \Rightarrow x = 1,3 \quad ; \quad a_1 = a_2 = \frac{2}{3} \cdot 1,3 = 0,8$$

$$M_{\max} = \frac{1}{2} \left(0,8 + \frac{4}{3} \right) \cdot (2 - 1,3) \cdot 10$$

PŘÍČINKOVÉ ČÁRY - UMÍSTĚNÍ ZATÍŽENÍ

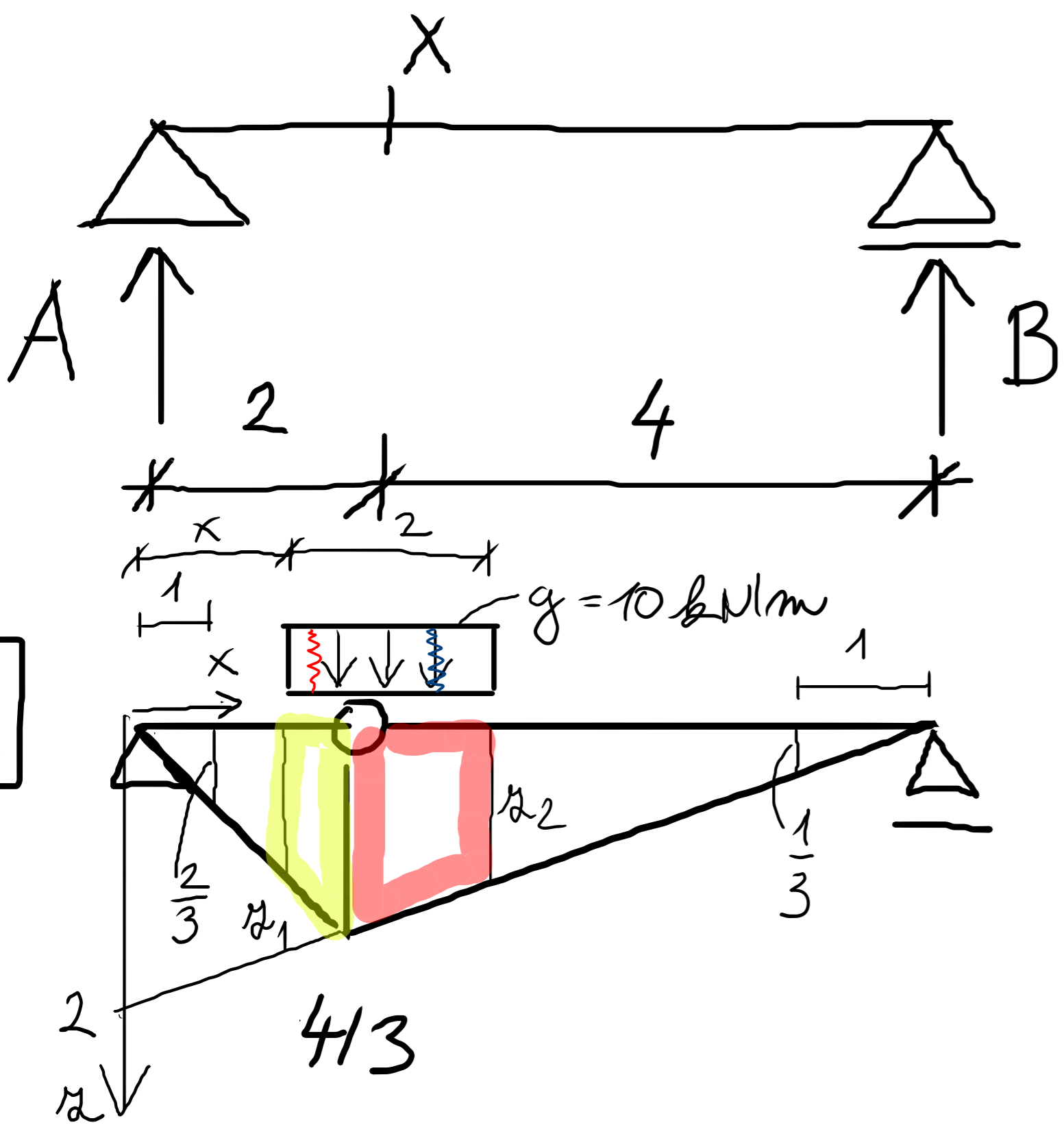

UMÍSTĚTE SPOJITÉ ZATÍŽENÍ DÉLKY 2m TAK, ŽE V MÍSTĚ x ZPŮSOBÍ MAXIMÁLNÍ OHYBOVÝ MOMENT.

1) VÝPOČET Z PŘEDPISU FUNKCE

$$a_1 = \frac{2}{3}x \quad ; \quad a_2 = 2 - \frac{1}{3}(x+2)$$

$$a_1 = a_2$$

$$\frac{2}{3}x = 2 - \frac{1}{3}(x+2) \Rightarrow x = 1,3 \quad ; \quad a_1 = a_2 = \frac{2}{3} \cdot 1,3 = 0,8$$

$$M_{\max} = \frac{1}{2} \left(0,8 + \frac{4}{3} \right) \cdot (2 - 1,3) \cdot 10 + \frac{1}{2} \cdot \left(0,8 + \frac{4}{3} \right) \cdot [2 - (2 - 1,3)] \cdot 10 =$$

PŘÍČINKOVÉ ČÁRY - UMÍSTĚNÍ ZATÍŽENÍ

UMÍSTĚTE SPOJITÉ ZATÍŽENÍ DÉLKY 2m TAK, ŽE V MÍSTĚ X ZPŮSOBÍ MAXIMÁLNÍ OHYBOVÝ MOMENT.

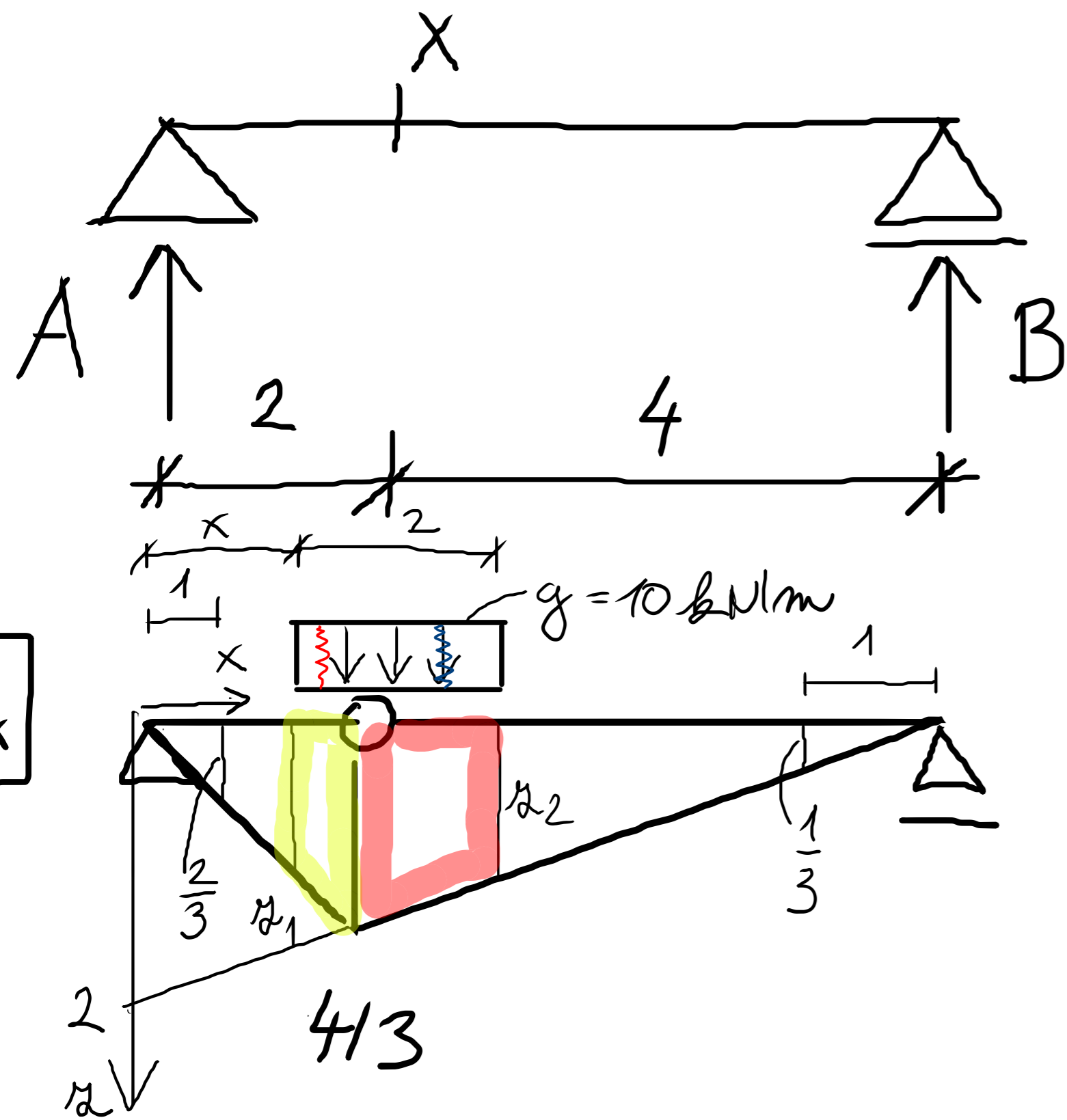

1) VÝPOČET Z PŘEDPISU FUNKCE

$$a_1 = \frac{2}{3}x \quad ; \quad a_2 = 2 - \frac{1}{3}(x+2)$$

$$a_1 = a_2$$

$$\frac{2}{3}x = 2 - \frac{1}{3}(x+2) \Rightarrow x = 1,3 \quad ; \quad a_1 = a_2 = \frac{2}{3} \cdot 1,3 = 0,8$$

$$M_{\max} = \frac{1}{2} \left(0,8 + \frac{4}{3} \right) \cdot (2 - 1,3) \cdot 10 + \frac{1}{2} \cdot \left(0,8 + \frac{4}{3} \right) \cdot [2 - (2 - 1,3)] \cdot 10 = 22,2 \text{ kNm}$$

PŘÍČINKOVÉ ČÁRY - UMÍSTĚNÍ ZATÍŽENÍ

UMÍSTĚTE SPOJITÉ ZATÍŽENÍ DÉLKY 2m TAK, ŽE V MÍSTĚ X ZPŮSOBÍ MAXIMÁLNÍ OHYBOVÝ MOMENT.

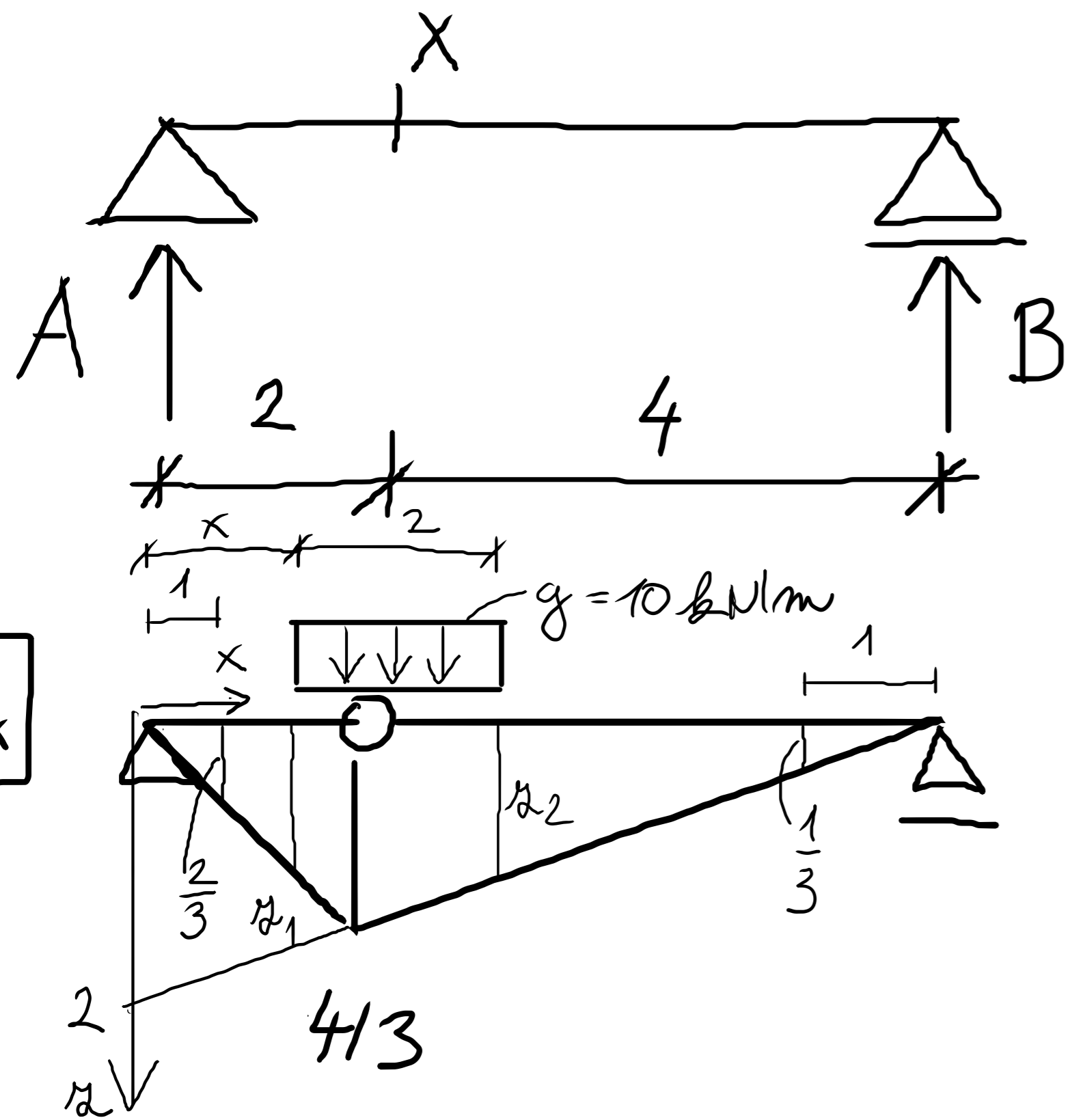

1) VÝPOČET Z PŘEDPISU FUNKCE

$$q_1 = \frac{2}{3}x \quad ; \quad q_2 = 2 - \frac{1}{3}(x+2)$$

$$q_1 = q_2$$

$$\frac{2}{3}x = 2 - \frac{1}{3}(x+2) \Rightarrow x = 1,3 \quad ; \quad q_1 = q_2 = \frac{2}{3} \cdot 1,3 = 0,8$$

$$M_{\max} = \frac{1}{2} \left(0,8 + \frac{4}{3} \right) \cdot (2 - 1,3) \cdot 10 + \frac{1}{2} \cdot \left(0,8 + \frac{4}{3} \right) \cdot [2 - (2 - 1,3)] \cdot 10 = 22,2 \text{ kNm}$$

2) GRAFICKY

PŘÍČINKOVÉ ČÁRY - UMÍSTĚNÍ ZATIŽENÍ

UMÍSTĚTE SPOJITÉ ZATIŽENÍ DÉLKY 2m TAK, ŽE V MÍSTĚ X ZPŮSOBÍ MAXIMÁLNÍ OHYBOVÝ MOMENT.

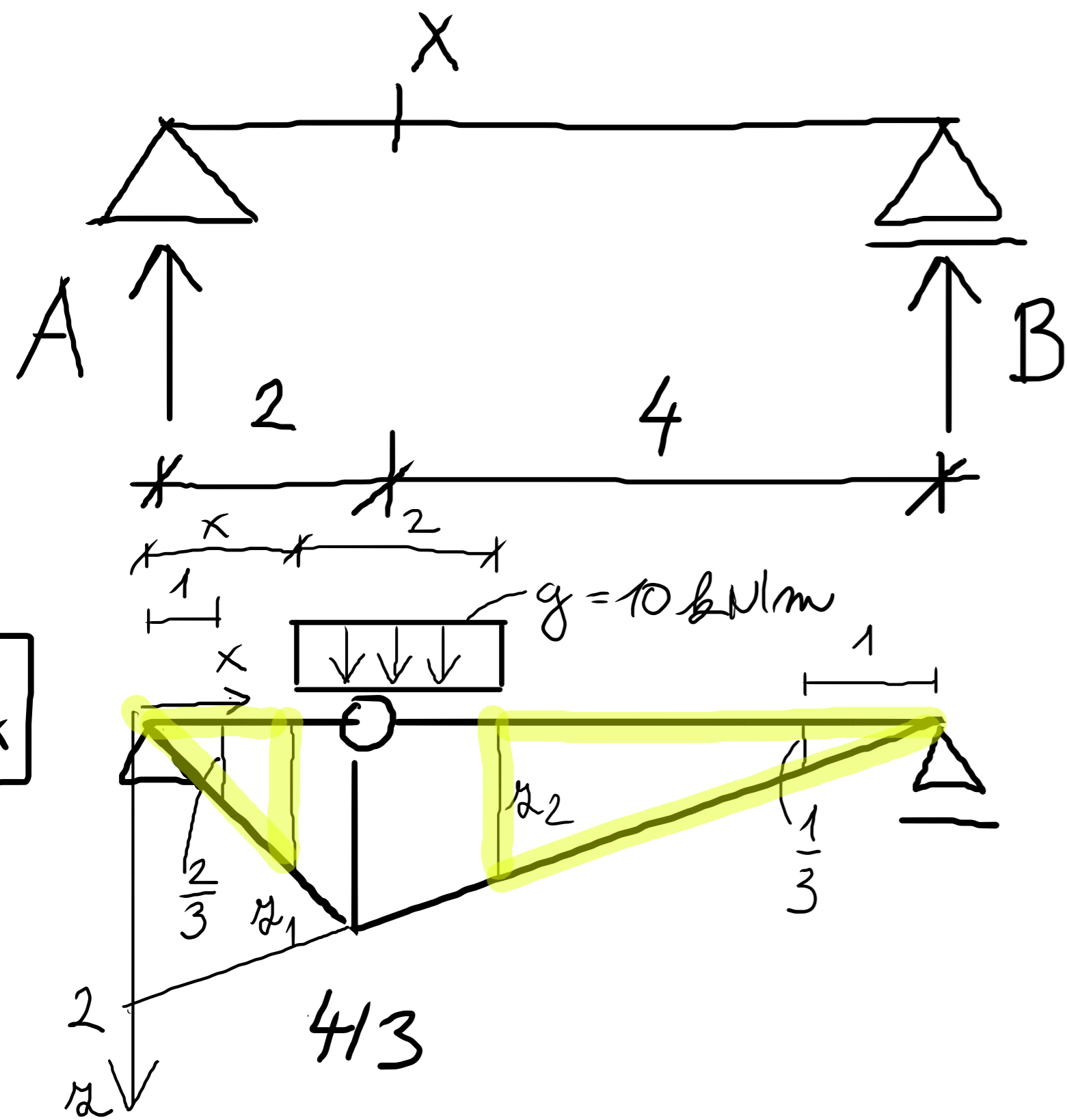

1) VÝPOČET Z PŘEDPISU FUNKCE

$$a_1 = \frac{2}{3}x \quad ; \quad a_2 = 2 - \frac{1}{3}(x+2)$$

$$a_1 = a_2$$

$$\frac{2}{3}x = 2 - \frac{1}{3}(x+2) \Rightarrow x = 1,3 \quad ; \quad a_1 = a_2 = \frac{2}{3} \cdot 1,3 = 0,8$$

$$M_{\max} = \frac{1}{2} \left(0,8 + \frac{4}{3} \right) \cdot (2 - 1,3) \cdot 10 + \frac{1}{2} \cdot \left(0,8 + \frac{4}{3} \right) \cdot [2 - (2 - 1,3)] \cdot 10 = 22,2 \text{ kNm}$$

2) GRAFICKY

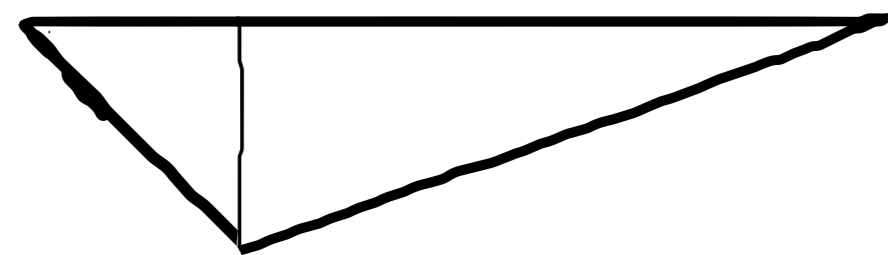

PŘÍČINKOVÉ ČÁRY - UMÍSTĚNÍ ZATIŽENÍ

UMÍSTĚTE SPOJITÉ ZATIŽENÍ DÉLKY 2m TAK, ŽE V MÍSTĚ X ZPŮSOBÍ MAXIMÁLNÍ OHYBOVÝ MOMENT.

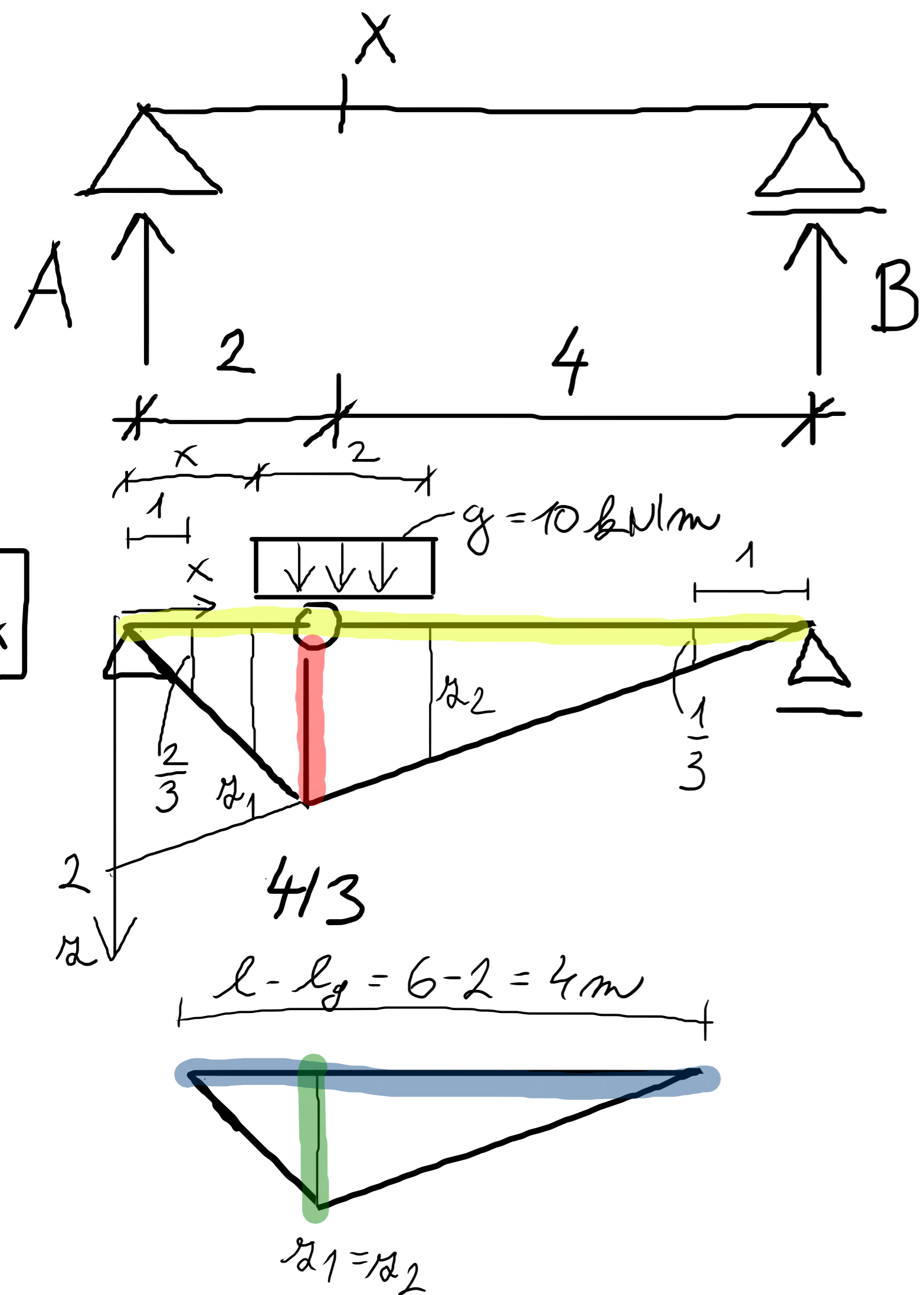

1) VÝPOČET Z PŘEDPISU FUNKCE

$$R_1 = \frac{2}{3}x \quad ; \quad R_2 = 2 - \frac{1}{3}(x+2)$$

$$R_1 = R_2$$

$$\frac{2}{3}x = 2 - \frac{1}{3}(x+2) \Rightarrow x = 1,3 \quad ; \quad R_1 = R_2 = \frac{2}{3} \cdot 1,3 = 0,8$$

$$M_{\max} = \frac{1}{2} \left(0,8 + \frac{4}{3} \right) \cdot (2 - 1,3) \cdot 10 + \frac{1}{2} \cdot \left(0,8 + \frac{4}{3} \right) \cdot [2 - (2 - 1,3)] \cdot 10 = 22,2 \text{ kNm}$$

2) GRAFICKY

$$\frac{R_1}{4} = \frac{4/3}{6}$$

PŘÍČINKOVÉ ČÁRY - UMÍSTĚNÍ ZATIŽENÍ

UMÍSTĚTE SPOJITÉ ZATIŽENÍ DÉLKY 2m TAK, ŽE V MÍSTĚ X ZPŮSOBÍ MAXIMÁLNÍ OHYBOVÝ MOMENT.

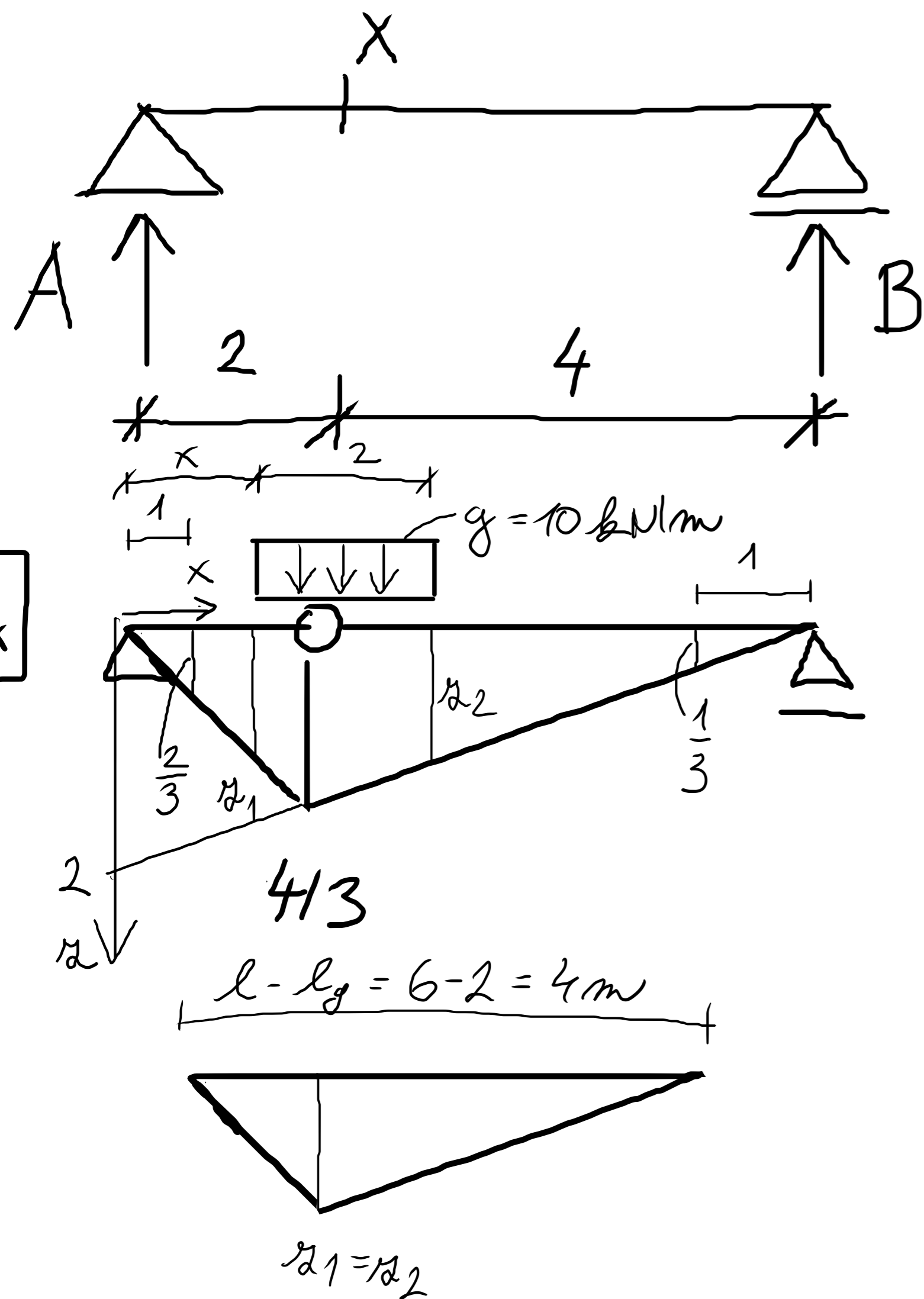

1) VÝPOČET Z PŘEDPISU FUNKCE

$$R_1 = \frac{2}{3}x \quad ; \quad R_2 = 2 - \frac{1}{3}(x+2)$$

$$R_1 = R_2$$

$$\frac{2}{3}x = 2 - \frac{1}{3}(x+2) \Rightarrow x = 1,3 \quad ; \quad R_1 = R_2 = \frac{2}{3} \cdot 1,3 = 0,8$$

$$M_{\max} = \frac{1}{2} \left(0,8 + \frac{4}{3} \right) \cdot (2 - 1,3) \cdot 10 + \frac{1}{2} \cdot \left(0,8 + \frac{4}{3} \right) \cdot [2 - (2 - 1,3)] \cdot 10 = 22,2 \text{ kNm}$$

2) GRAFICKY

$$\frac{R_1}{4} = \frac{4/3}{6} \rightarrow R_1 = R_2 = \frac{8}{9} = 0,8$$

PŘÍČINKOVÉ ČÁRY - UMÍSTĚNÍ ZATÍŽENÍ

UMÍSTĚTE SPOJITÉ ZATÍŽENÍ DÉLKY 2m TAK, ŽE V MÍSTĚ X ZPŮSOBÍ MAXIMÁLNÍ OHYBOVÝ MOMENT.

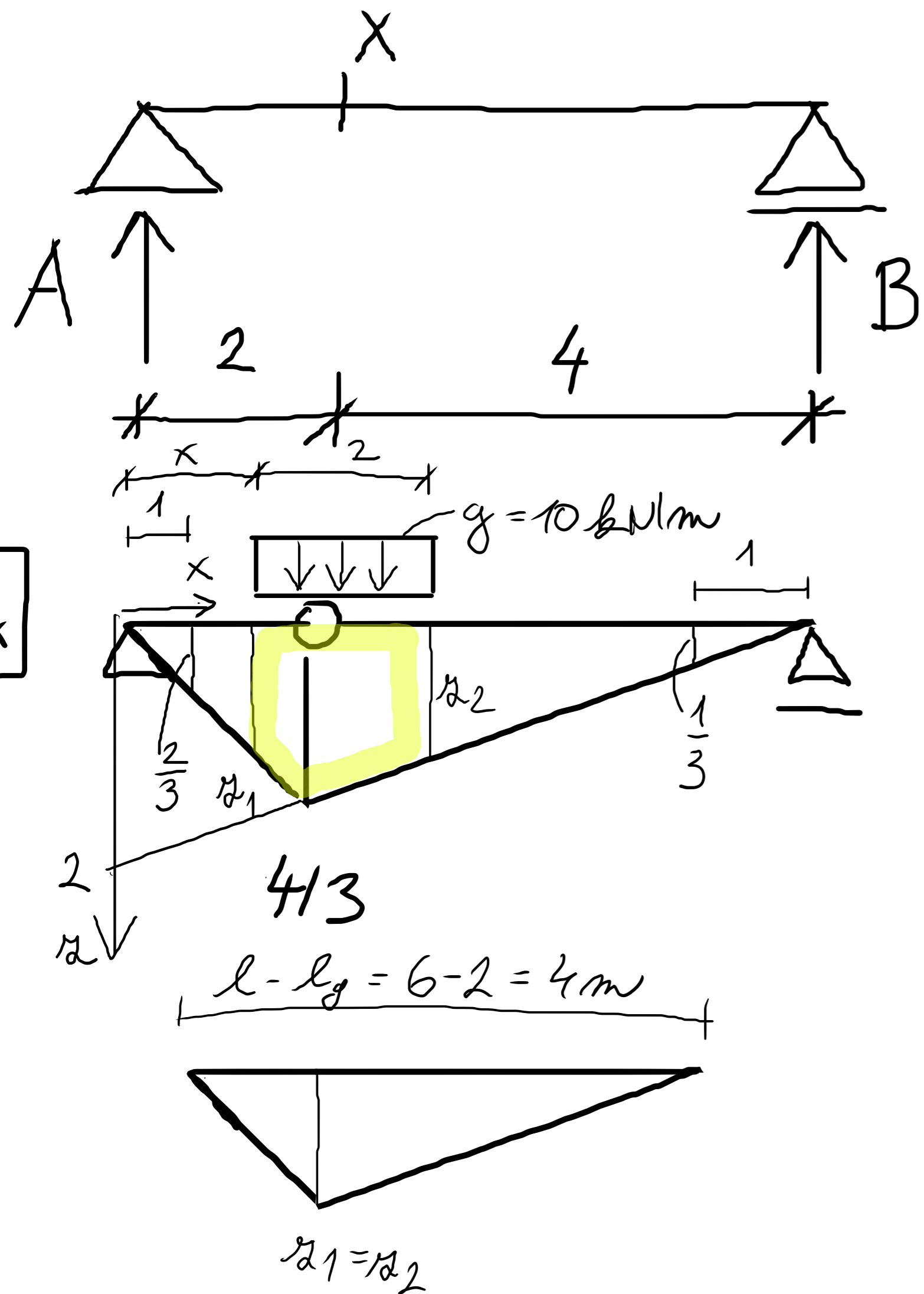

1) VÝPOČET Z PŘEDPISU FUNKCE

$$a_1 = \frac{2}{3}x \quad ; \quad a_2 = 2 - \frac{1}{3}(x+2)$$

$$a_1 = a_2$$

$$\frac{2}{3}x = 2 - \frac{1}{3}(x+2) \Rightarrow x = 1,3 \quad ; \quad a_1 = a_2 = \frac{2}{3} \cdot 1,3 = 0,8$$

$$M_{\max} = \frac{1}{2} \left(0,8 + \frac{4}{3} \right) \cdot (2 - 1,3) \cdot 10 + \frac{1}{2} \cdot \left(0,8 + \frac{4}{3} \right) \cdot [2 - (2 - 1,3)] \cdot 10 = 22,2 \text{ kNm}$$

2) GRAFICKY

$$\frac{a_1}{4} = \frac{4/3}{6} \rightarrow a_1 = a_2 = \frac{8}{9} = 0,8$$

PŘÍČINKOVÉ ČÁRY - UMÍSTĚNÍ ZATÍŽENÍ

UMÍSTĚTE SPOJITÉ ZATÍŽENÍ DÉLKY 2m TAK, ŽE V MÍSTĚ X ZPŮSOBÍ MAXIMÁLNÍ OHYBOVÝ MOMENT.

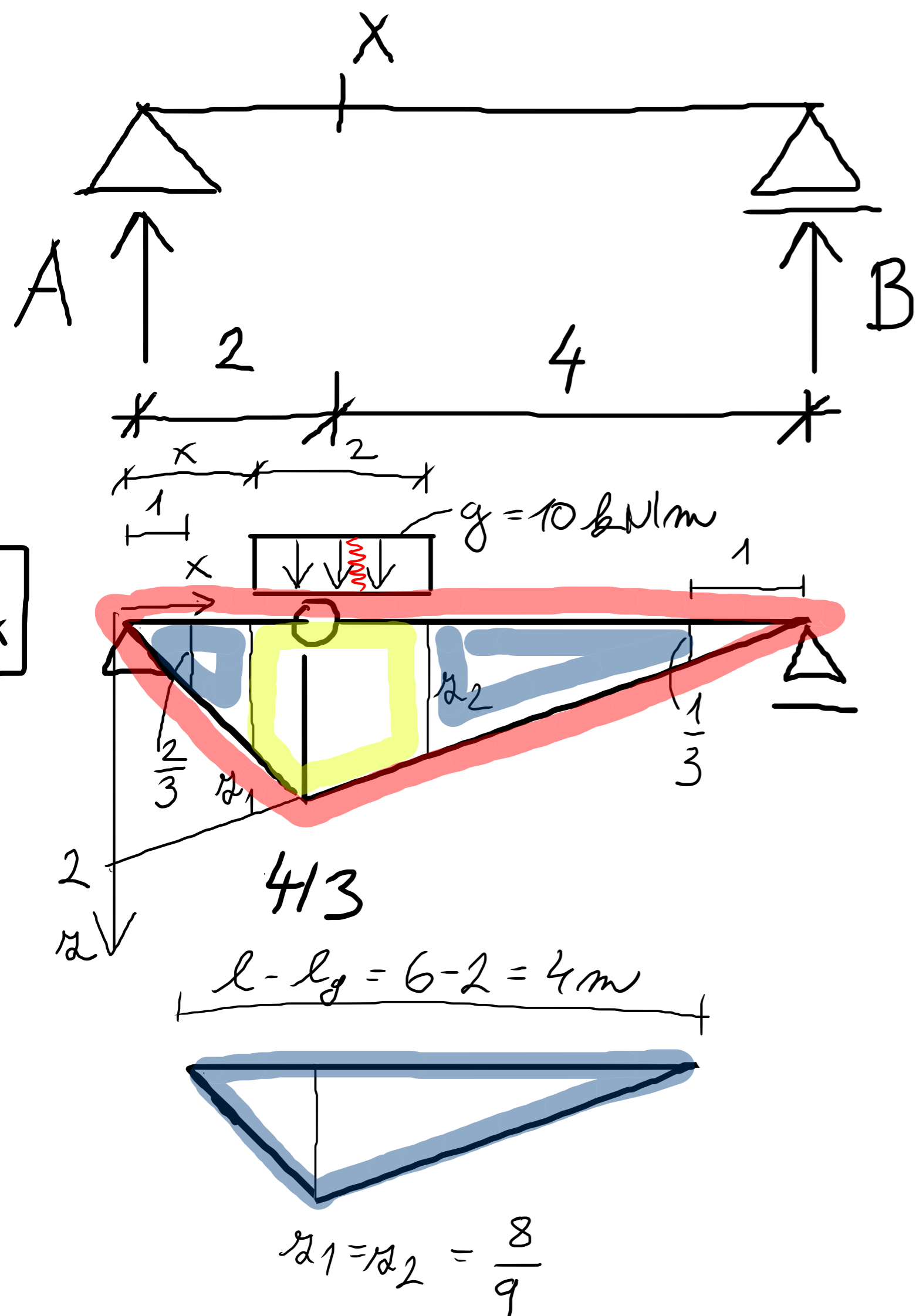

1) VÝPOČET Z PŘEDPISU FUNKCE

$$a_1 = \frac{2}{3}x \quad ; \quad a_2 = 2 - \frac{1}{3}(x+2)$$

$$a_1 = a_2$$

$$\frac{2}{3}x = 2 - \frac{1}{3}(x+2) \Rightarrow x = 1,3 \quad ; \quad a_1 = a_2 = \frac{2}{3} \cdot 1,3 = 0,8$$

$$M_{max} = \frac{1}{2} \left(0,8 + \frac{4}{3} \right) \cdot (2 - 1,3) \cdot 10 + \frac{1}{2} \cdot \left(0,8 + \frac{4}{3} \right) \cdot [2 - (2 - 1,3)] \cdot 10 = 22,2 \text{ kNm}$$

2) GRAFICKY

$$\frac{a_1}{4} = \frac{4/3}{6} \rightarrow a_1 = a_2 = \frac{8}{9} = 0,8$$

$$M_{max} = \left(\frac{1}{2} \cdot \frac{4}{3} \cdot 6 - \frac{1}{2} \cdot \frac{8}{9} \cdot 4 \right) \cdot 10 =$$

PŘÍČINKOVÉ ČÁRY - UMÍSTĚNÍ ZATIŽENÍ

UMÍSTĚTE SPOJITÉ ZATIŽENÍ DÉLKY 2m TAK, ŽE V MÍSTĚ X ZPŮSOBÍ MAXIMÁLNÍ OHYBOVÝ MOMENT.

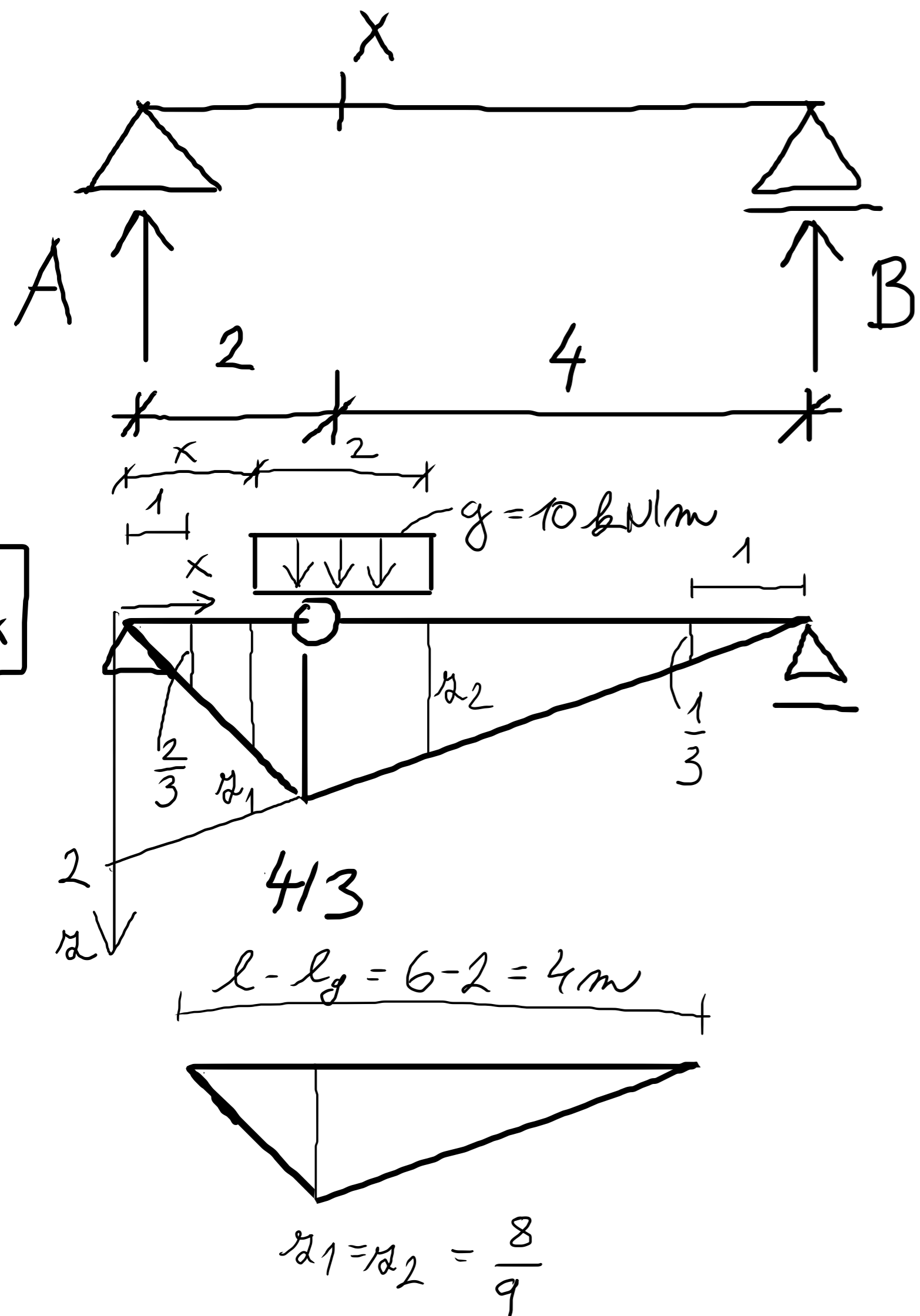

1) VÝPOČET Z PŘEDPISU FUNKCE

$$R_1 = \frac{2}{3}x \quad ; \quad R_2 = 2 - \frac{1}{3}(x+2)$$

$$R_1 = R_2$$

$$\frac{2}{3}x = 2 - \frac{1}{3}(x+2) \Rightarrow x = 1,3 \quad ; \quad R_1 = R_2 = \frac{2}{3} \cdot 1,3 = 0,8$$

$$M_{\max} = \frac{1}{2} \left(0,8 + \frac{4}{3} \right) \cdot (2 - 1,3) \cdot 10 + \frac{1}{2} \cdot \left(0,8 + \frac{4}{3} \right) \cdot [2 - (2 - 1,3)] \cdot 10 = 22,2 \text{ kNm}$$

2) GRAFICKY

$$\frac{R_1}{4} = \frac{4/3}{6} \rightarrow R_1 = R_2 = \frac{8}{9} = 0,8$$

$$M_{\max} = \left(\frac{1}{2} \cdot \frac{4}{3} \cdot 6 - \frac{1}{2} \cdot \frac{8}{9} \cdot 4 \right) \cdot 10 = 22,2 \text{ kNm}$$

PŘÍČINKOVÉ ČÁRY - UMÍSTĚNÍ ZATÍŽENÍ

PŘÍČINKOVÉ ČÁRY - UMÍSTĚNÍ ZATÍŽENÍ

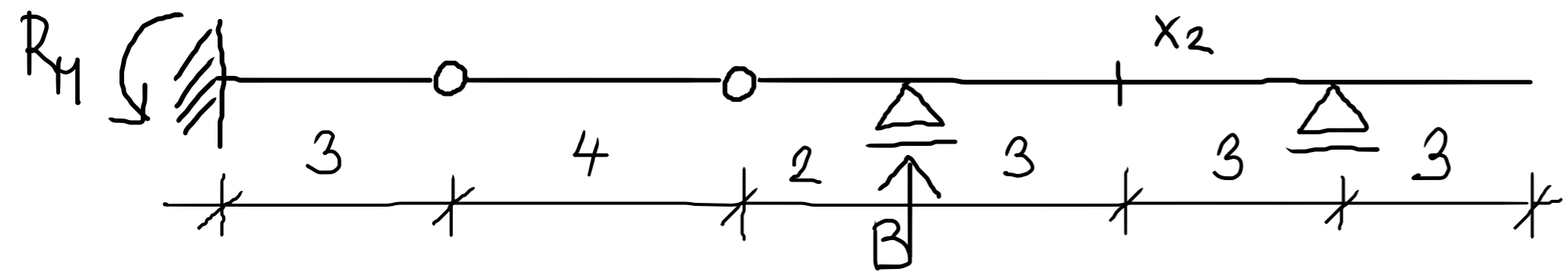

B

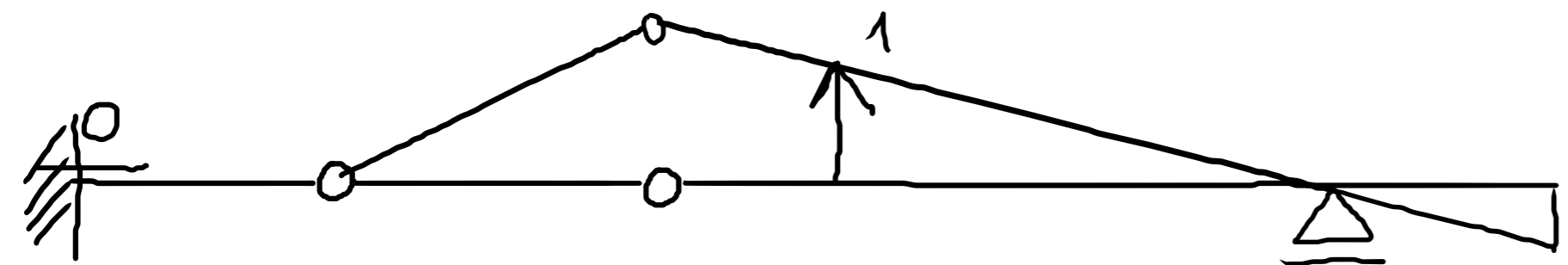

R_H

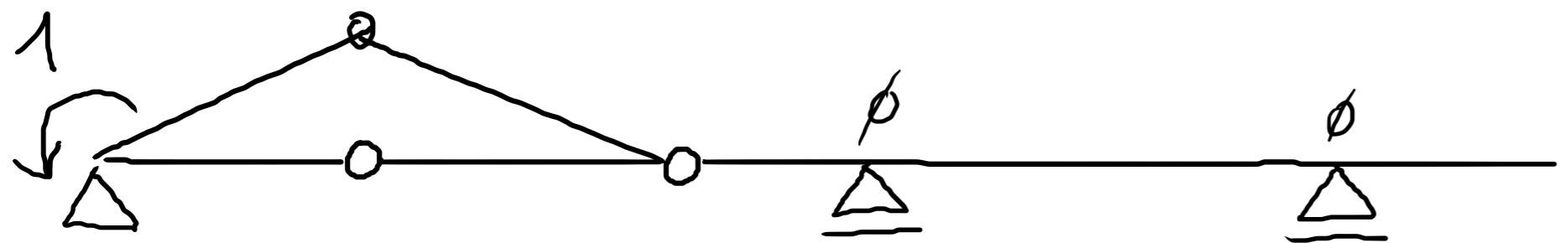

V_{x2}

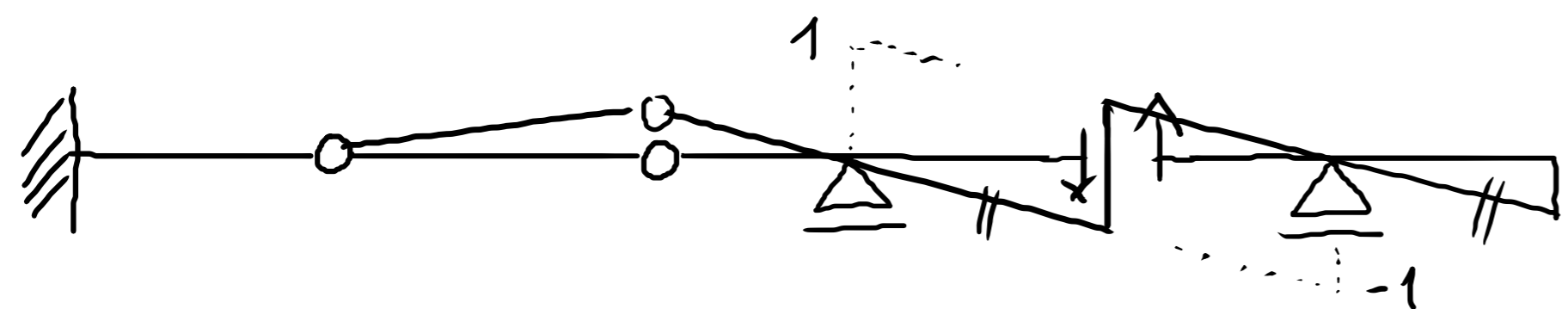

M_{x2}

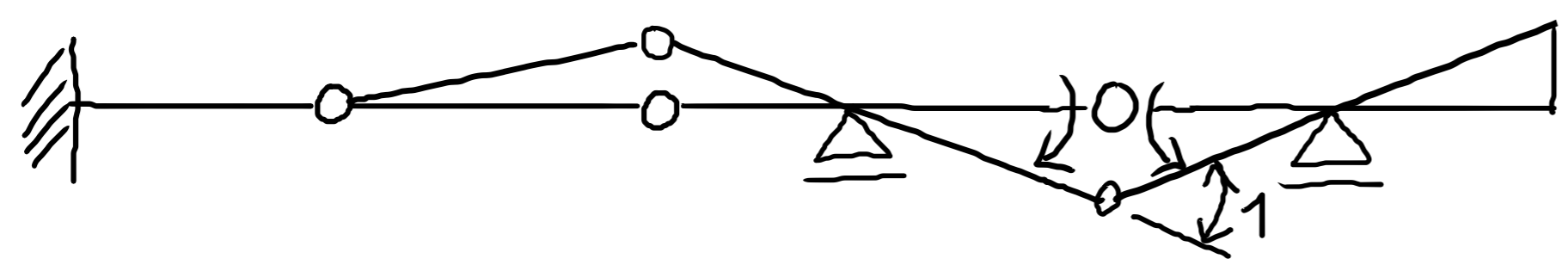

PŘÍČINKOVÉ ČÁRY - UMÍSTĚNÍ ZATIŽENÍ

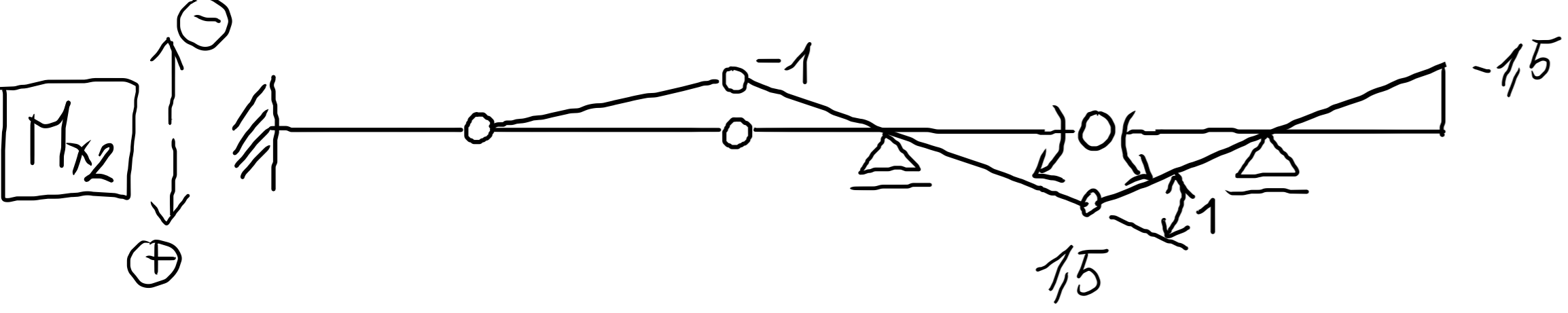
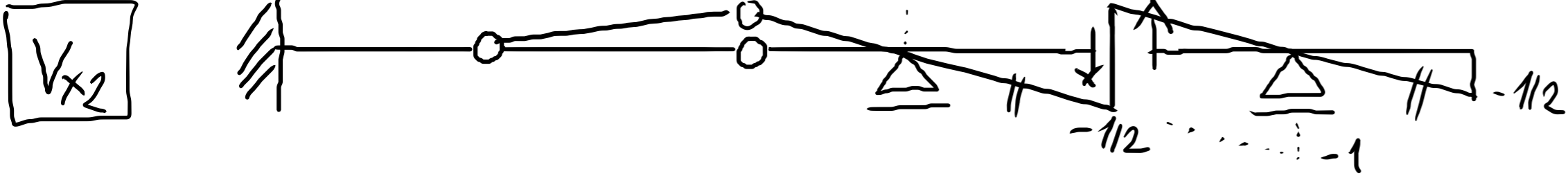
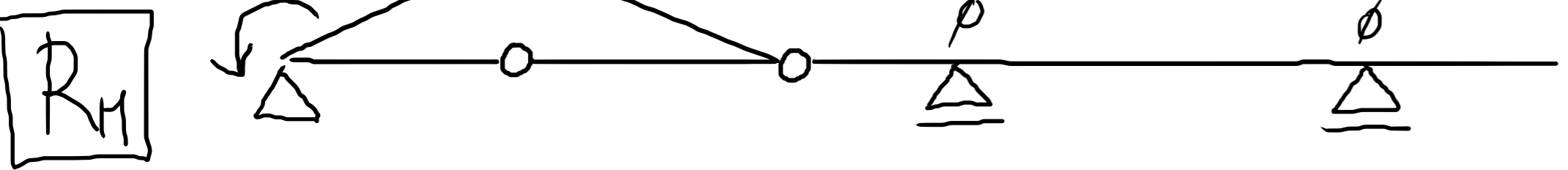
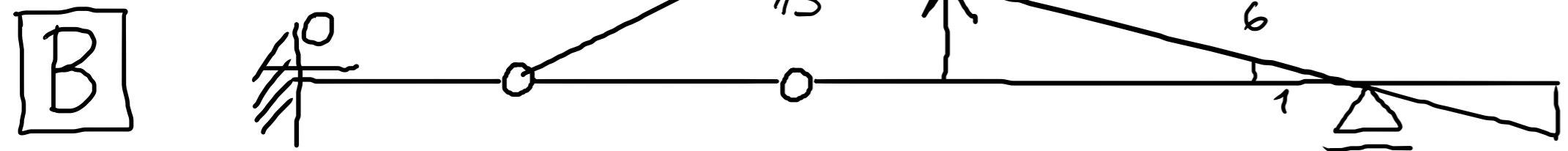
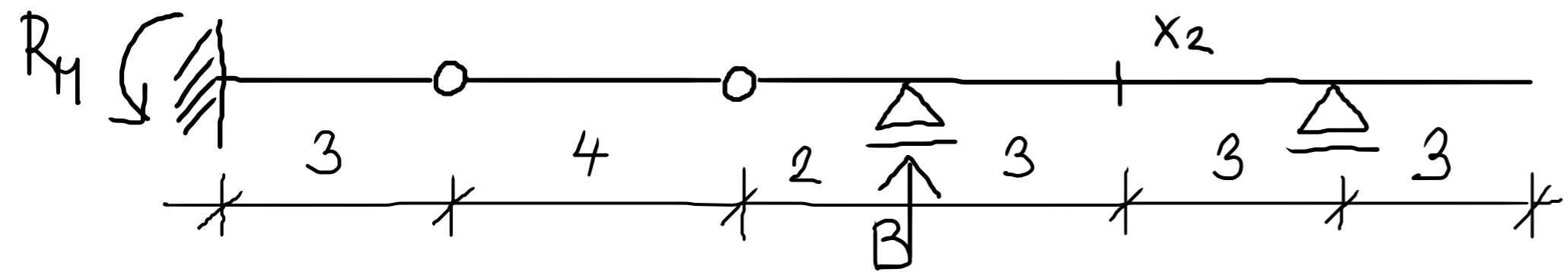

PŘÍČINKOVÉ ČÁRY - UMÍSTĚNÍ ZATÍŽENÍ

UMÍSTĚTE JEDNU SILU VELIKOSTI 10kN
A SPOJITÁ ZATÍŽENÍ VELIKOSTI 5kNm
PRO VÝPOČET EXTREMNÍCH HODNOT.

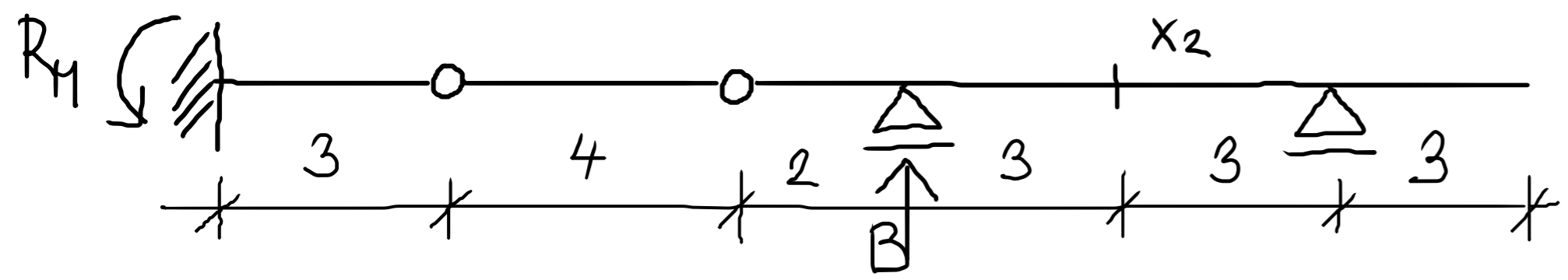

B

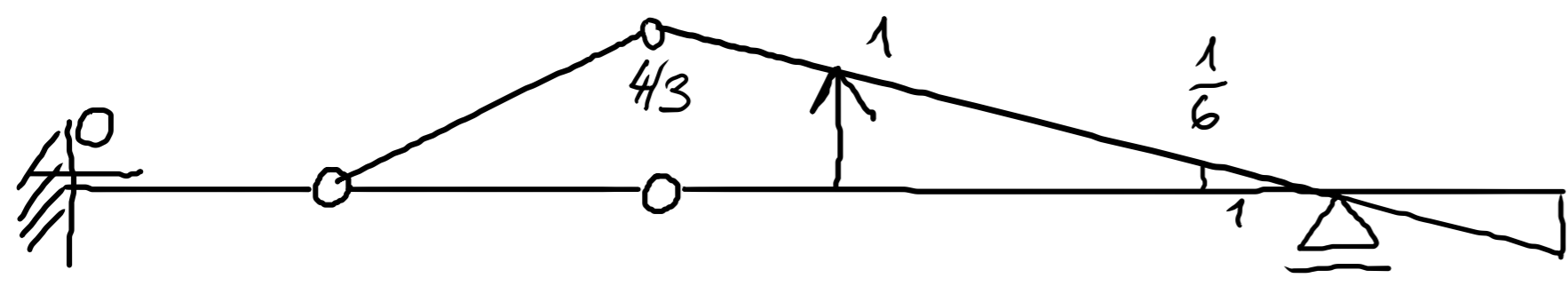

RH

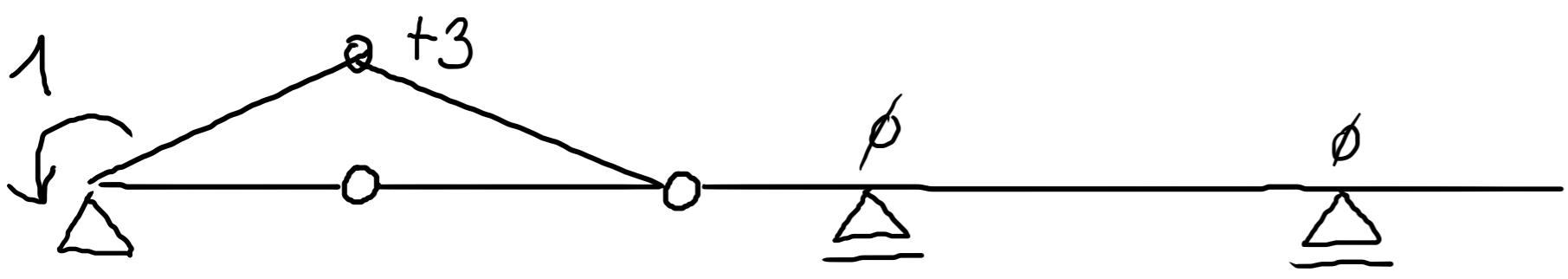

Vx2

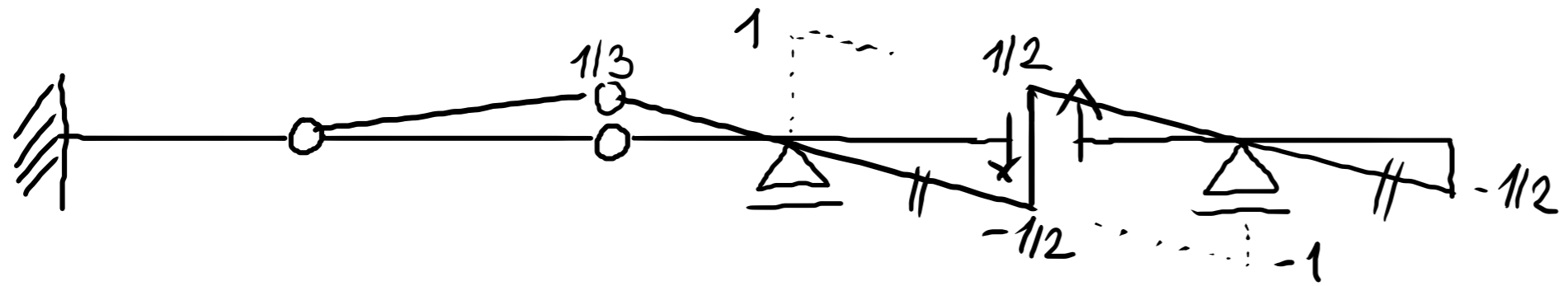

Mx2

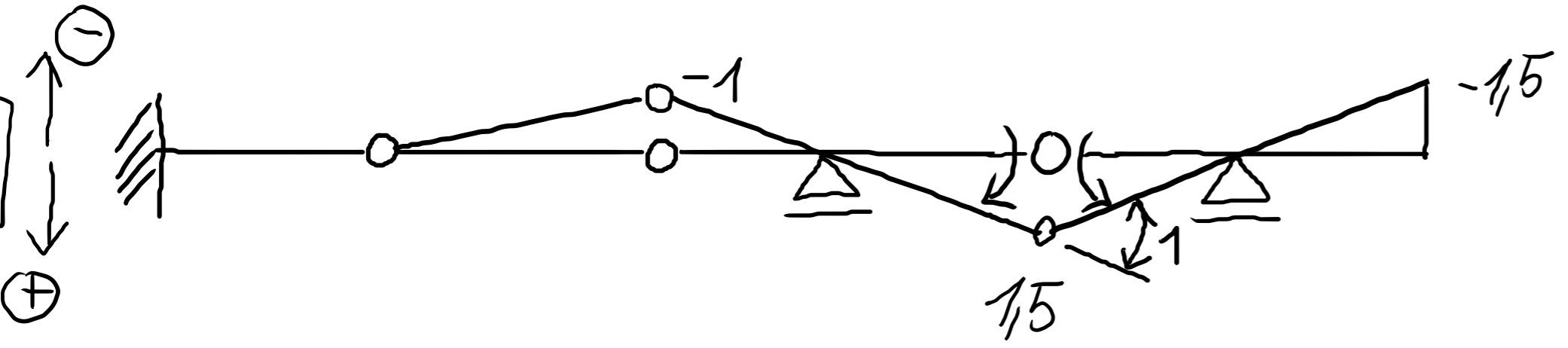

PŘÍČINKOVÉ ČÁRY - UMÍSTĚNÍ ZATIŽENÍ

UMÍSTĚTE JEDNU SILU VELIKOSTI 10kN
A SPOJITÁ ZATIŽENÍ VELIKOSTI 5kNm
PRO ÚPOČET EXTREMNÍCH HODNOT.

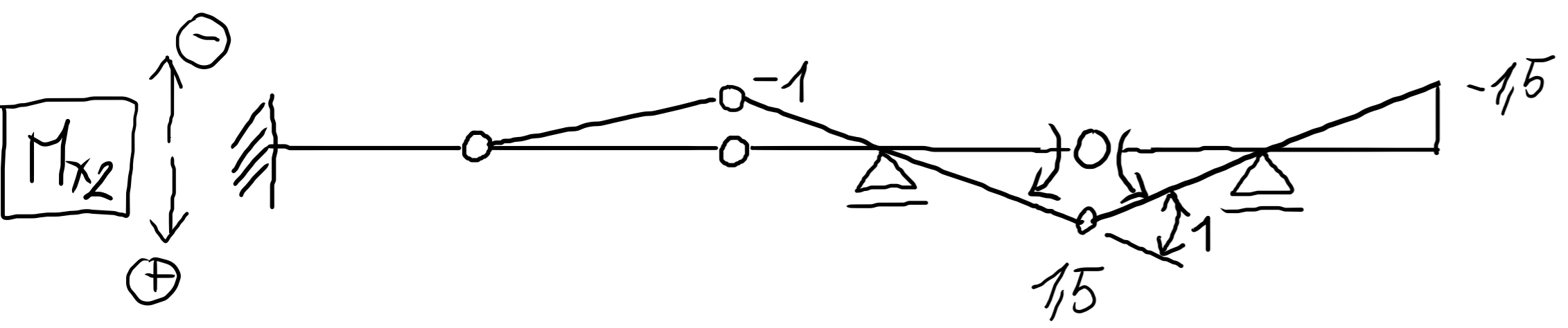
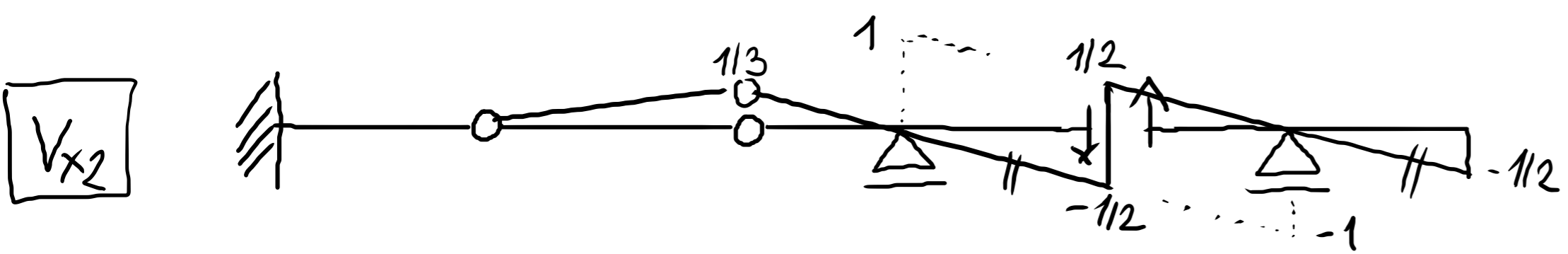
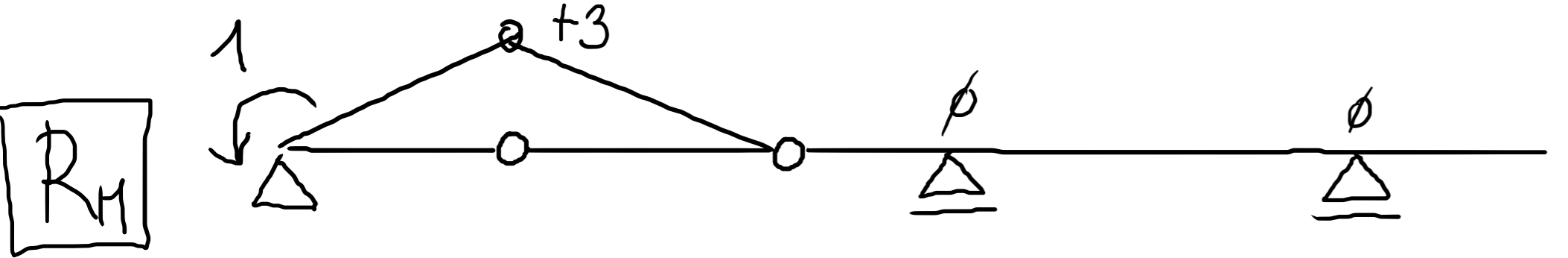
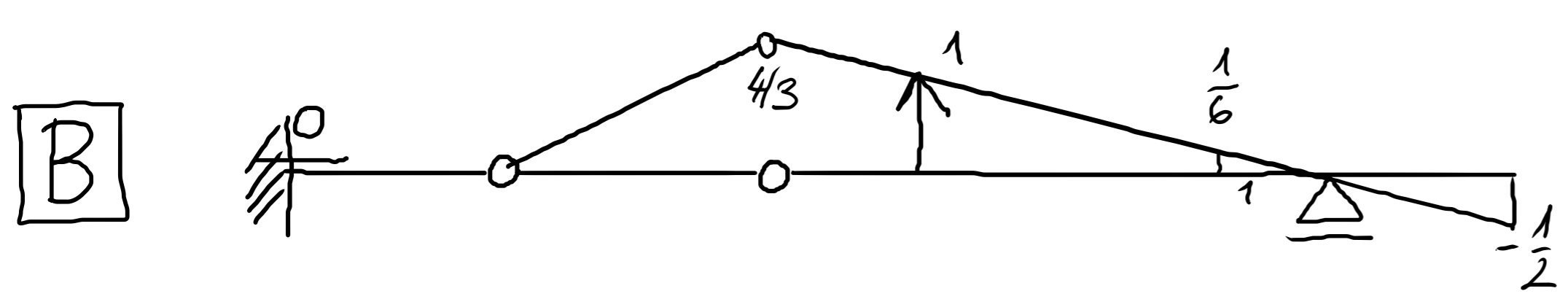
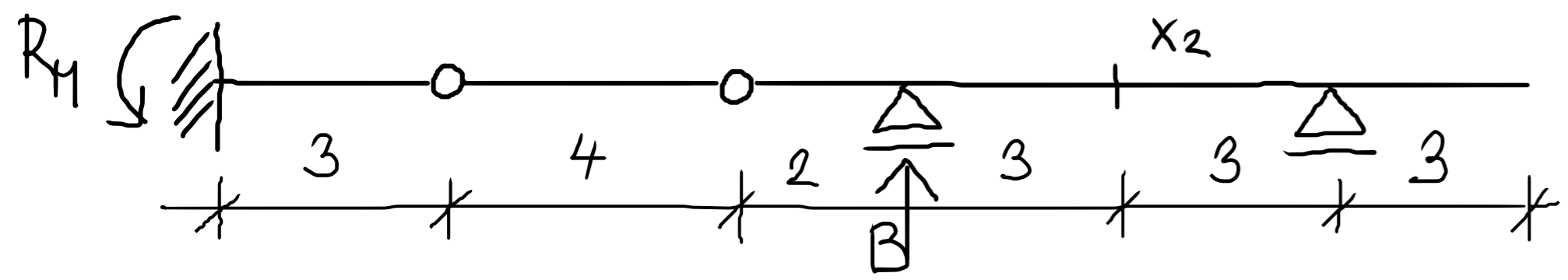

$B_{min} =$

PŘÍČINKOVÉ ČÁRY - UMÍSTĚNÍ ZATIŽENÍ

UMÍSTĚTE JEDNU SILU VELIKOSTI 10kN
A SPOJITÁ ZATIŽENÍ VELIKOSTI 5kNm
PRO ÚPOČET EXTREMNÍCH HODNOT.

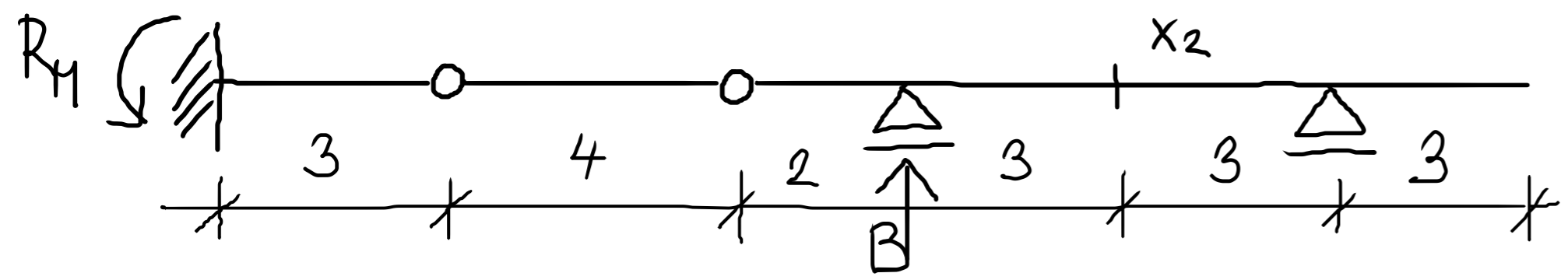

B

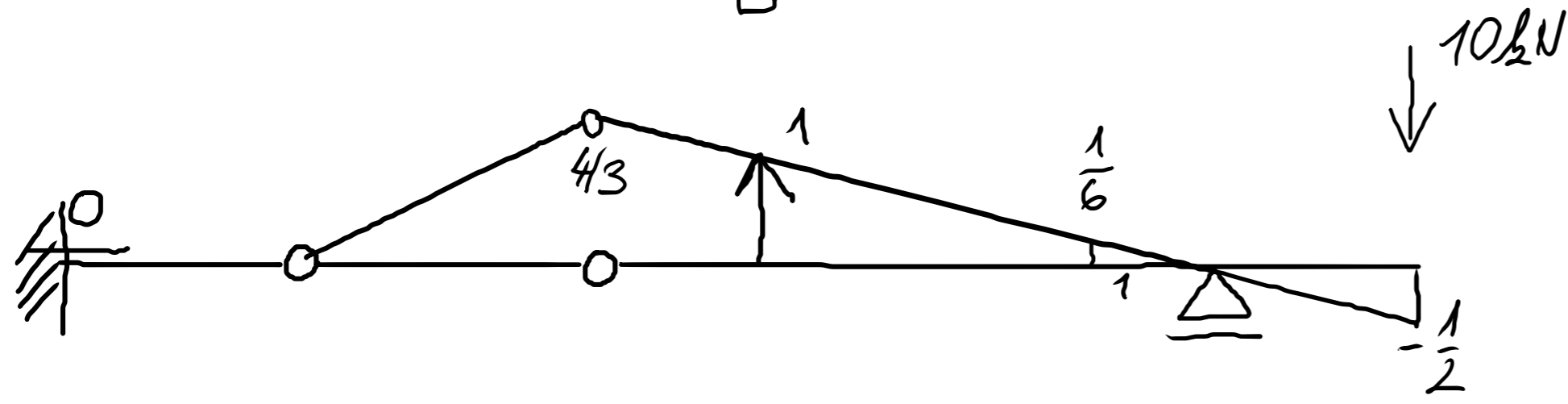

$B_{min} =$

R_H

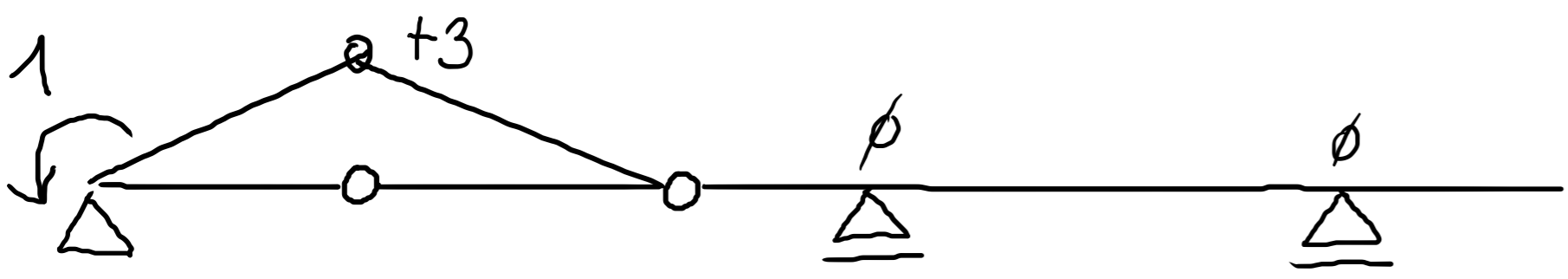

V_{x2}

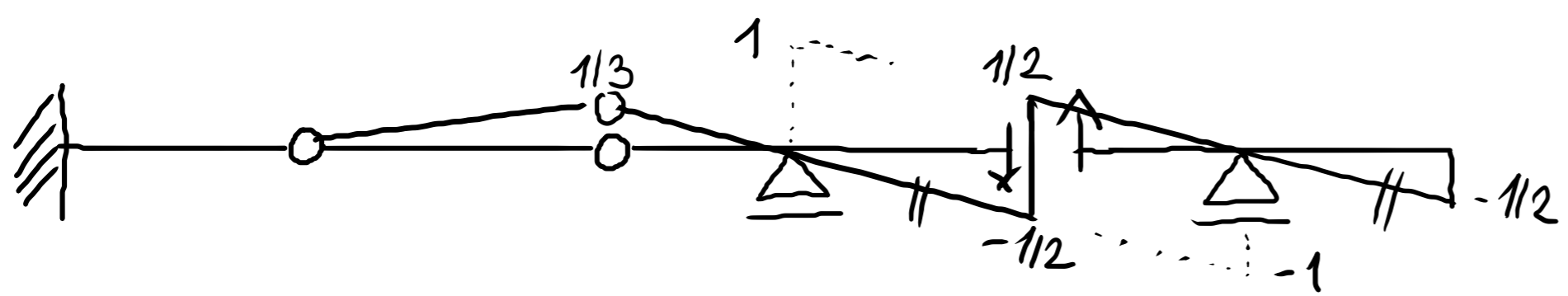

M_{x2}

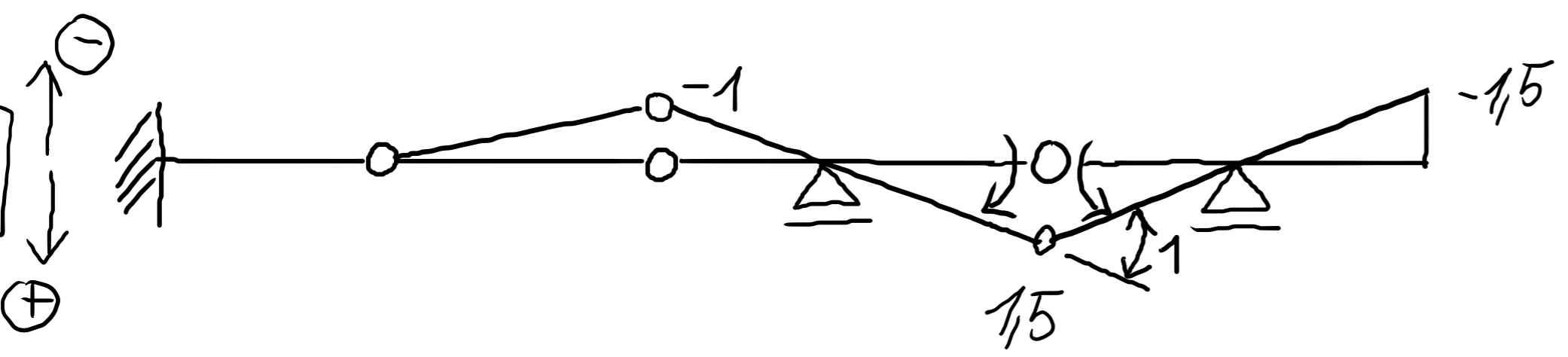

PŘÍČINKOVÉ ČÁRY - UMÍSTĚNÍ ZATIŽENÍ

UMÍSTĚTE JEDNU SILU VELIKOSTI 10kN
A SPOJITÁ ZATIŽENÍ VELIKOSTI 5kNm
PRO ÚPOČET EXTREMNÍCH HODNOT.

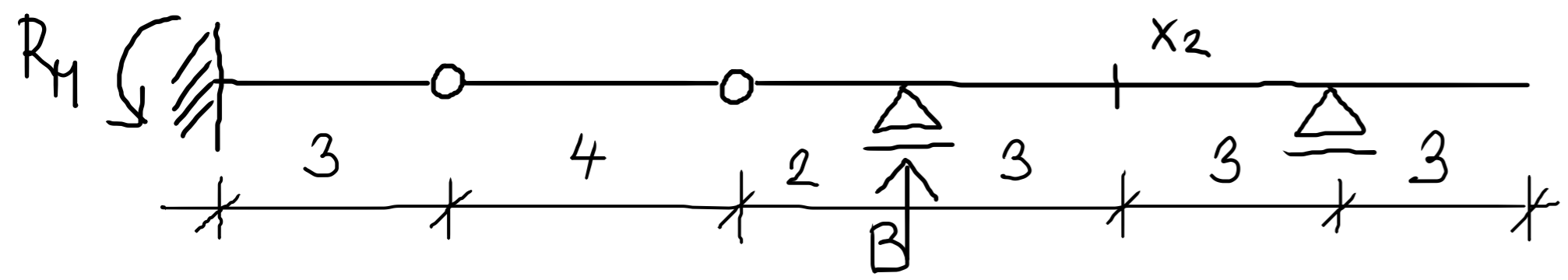

B

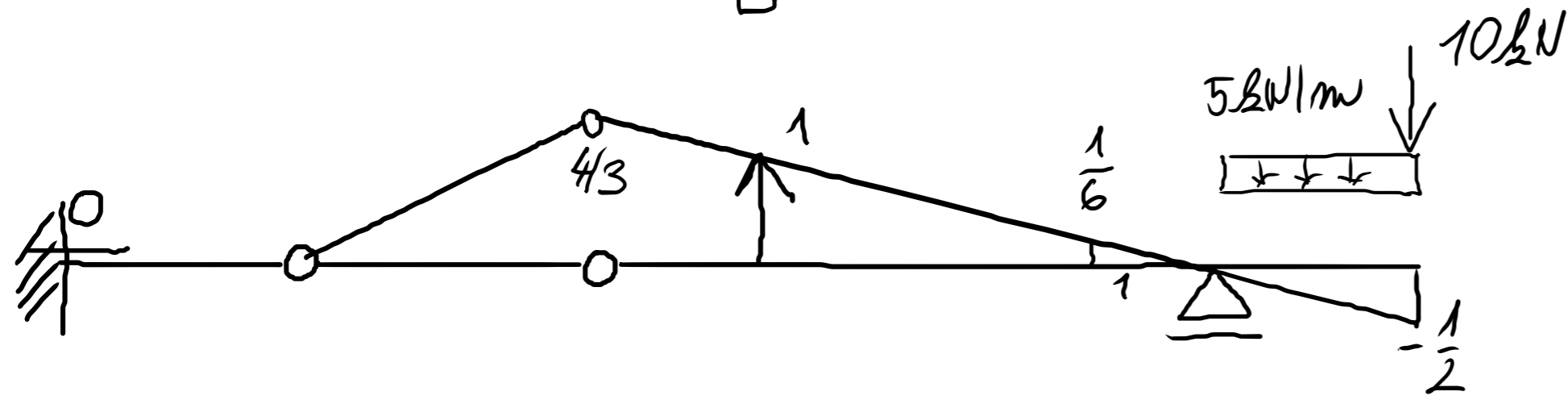

$B_{min} =$

R_H

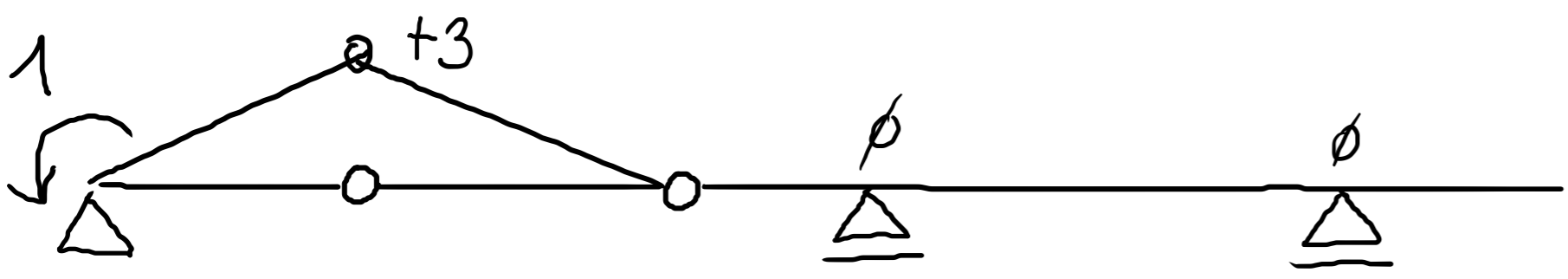

V_{x_2}

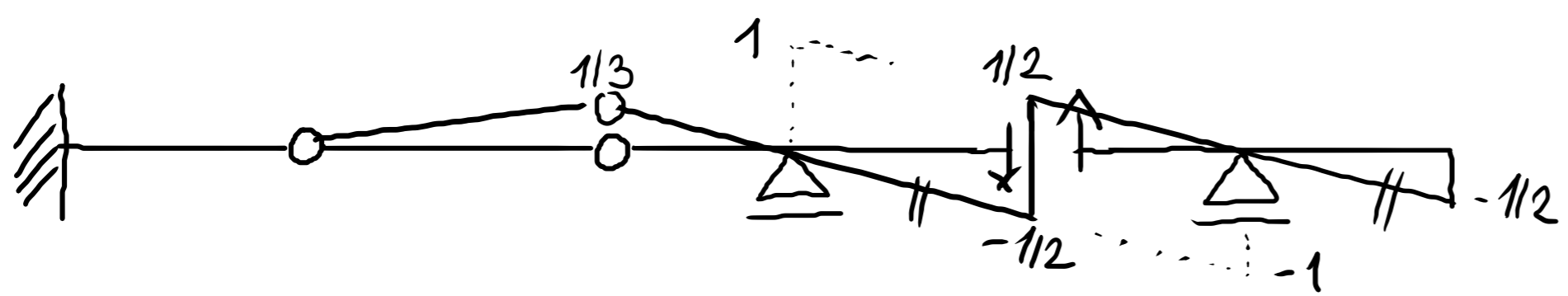

M_{x_2}

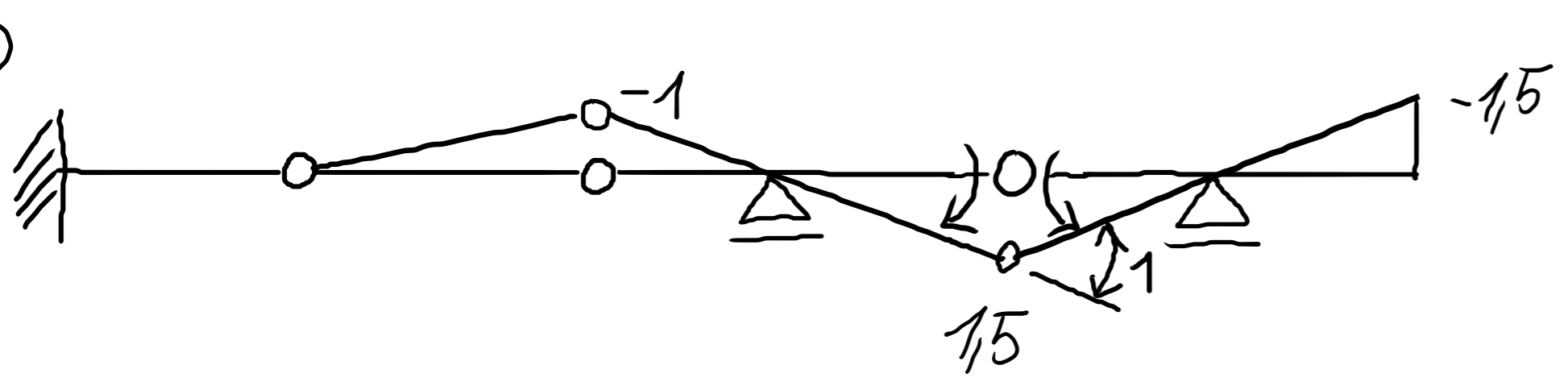

PŘÍČINKOVÉ ČÁRY - UMÍSTĚNÍ ZATIŽENÍ

UMÍSTĚTE JEDNU SILU VELIKOSTI 10kN
A SPOJITÁ ZATIŽENÍ VELIKOSTI 5kNm
PRO VÝPOČET EXTREMŇÍCH HODNOT.

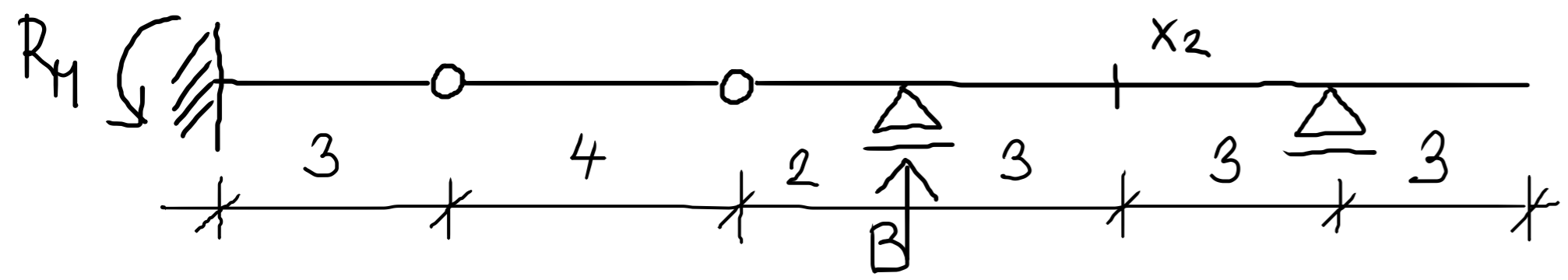

$$B_{min} = 10 \cdot \left(-\frac{1}{2}\right) + 5 \cdot 3 \cdot \frac{1}{2} \left(-\frac{1}{2}\right) = -8,75 \text{ kN}$$

B

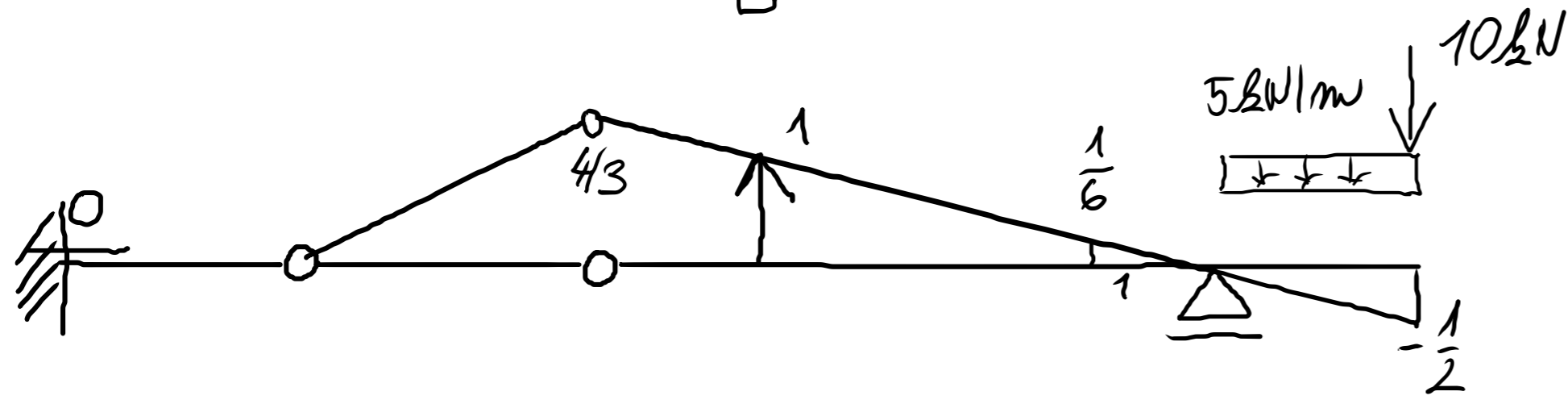

R_H

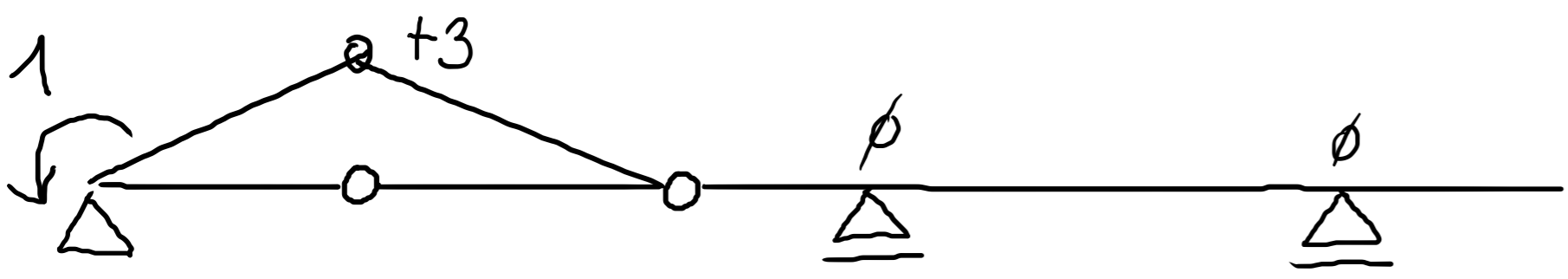

V_{x2}

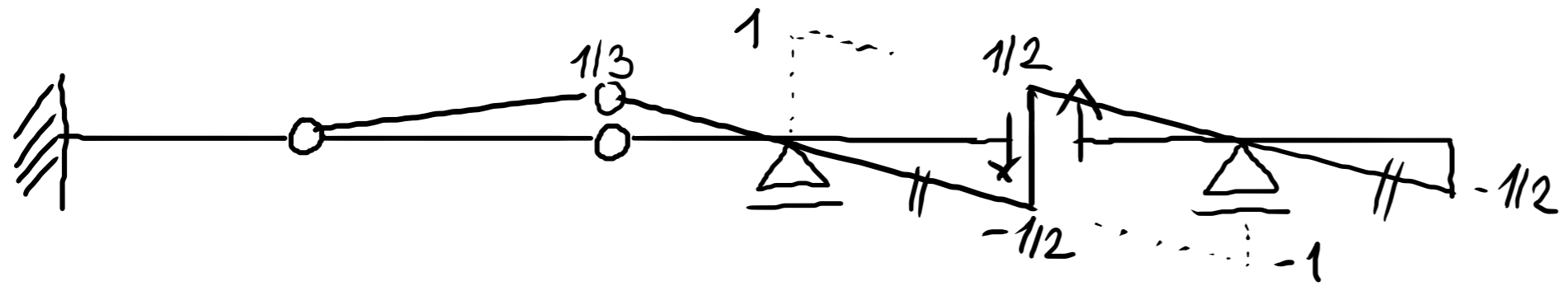

M_{x2}

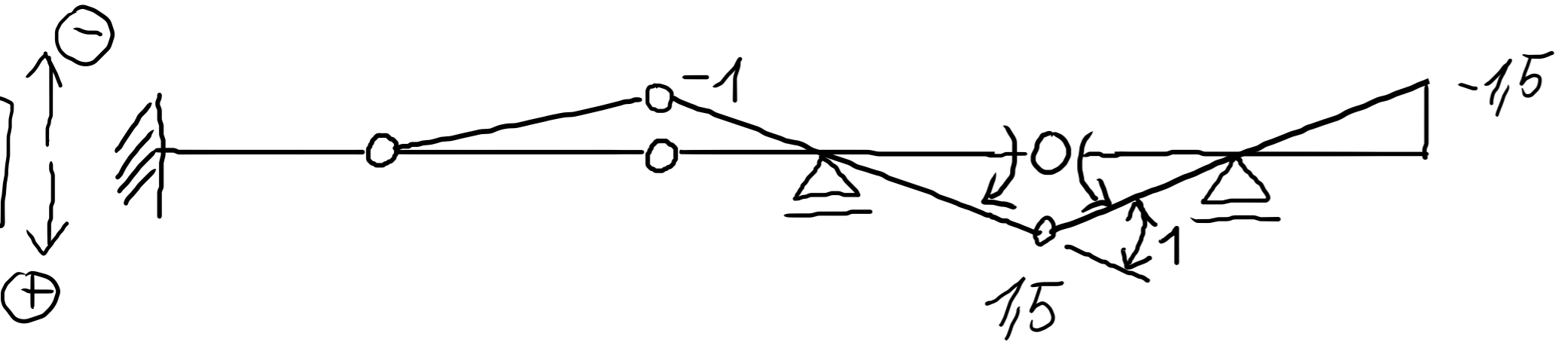

PŘÍČINKOVÉ ČÁRY - UMÍSTĚNÍ ZATIŽENÍ

UMÍSTĚTE JEDNU SILU VELIKOSTI 10kN
A SPOJITÁ ZATIŽENÍ VELIKOSTI 5kNm
PRO VÝPOČET EXTREMNÍCH HODNOT.

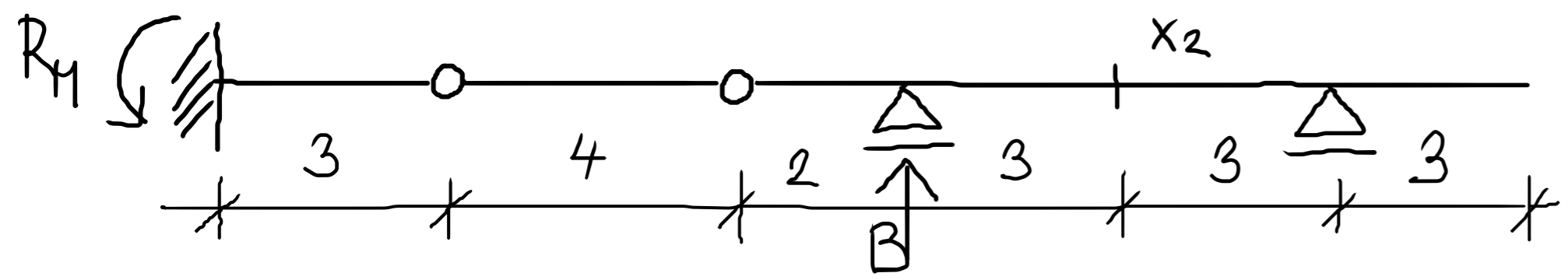

B

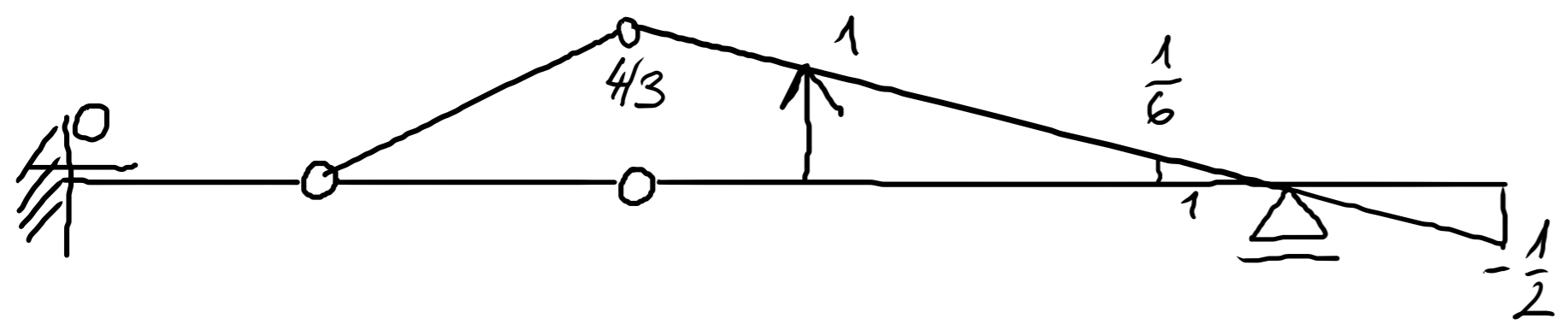

R_H

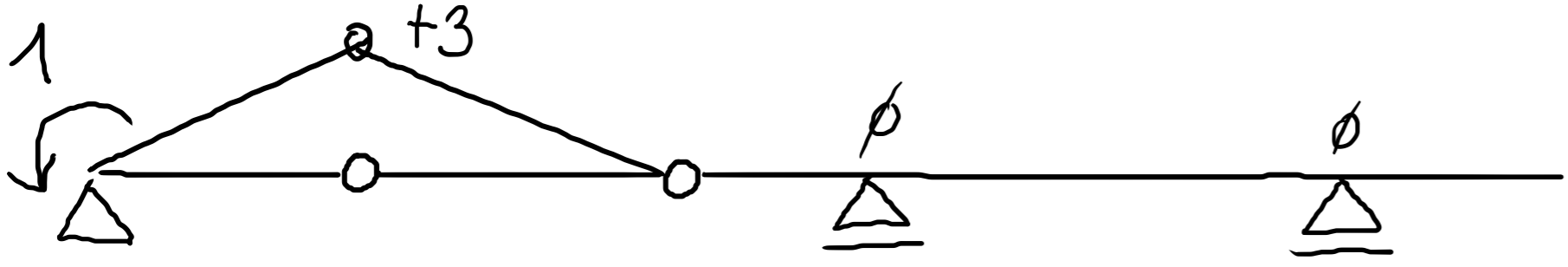

V_{x2}

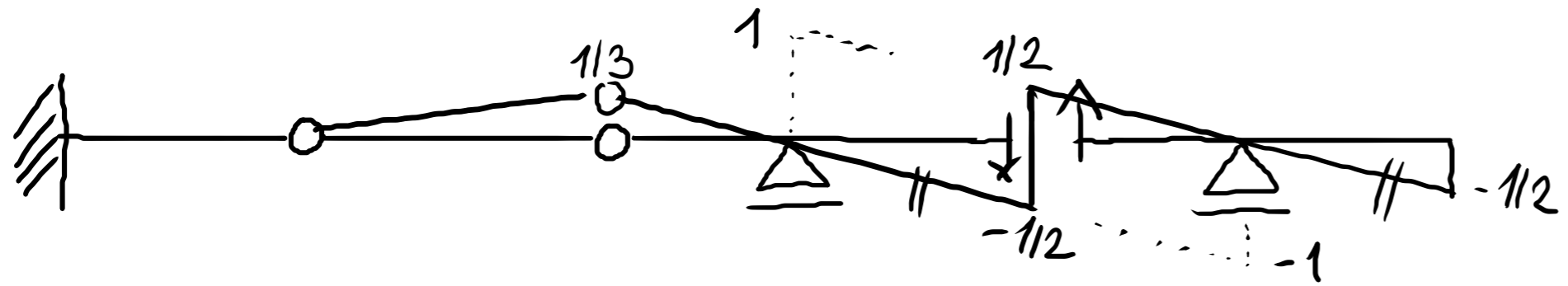

M_{x2}

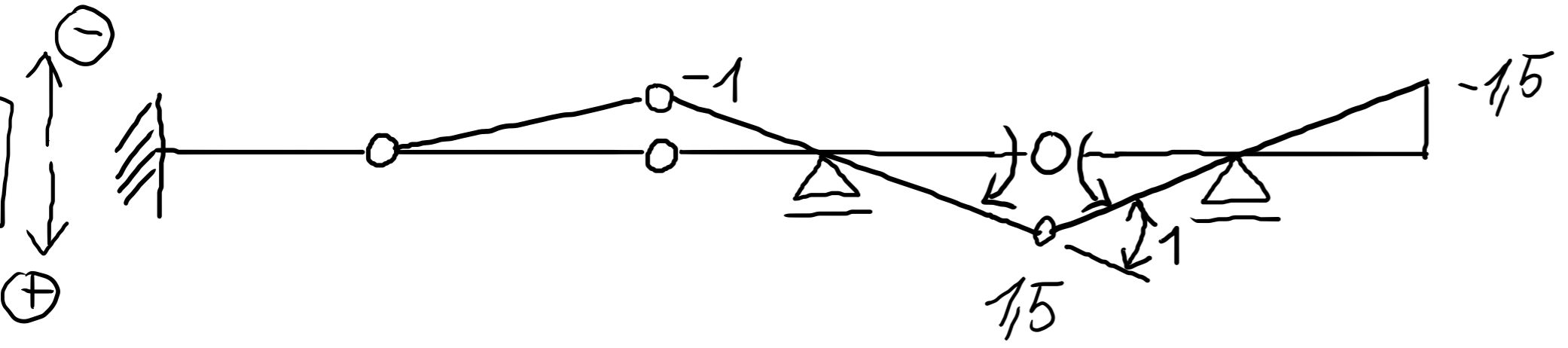

$$B_{min} = 10 \cdot \left(-\frac{1}{2}\right) + 5 \cdot 3 \cdot \frac{1}{2} \left(-\frac{1}{2}\right) = -8,75 \text{ kN}$$

$$B_{max} =$$

PŘÍČINKOVÉ ČÁRY - UMÍSTĚNÍ ZATIŽENÍ

UMÍSTĚTE JEDNU SILU VELIKOSTI 10kN
A SPOJITÁ ZATIŽENÍ VELIKOSTI 5kNm
PRO VÝPOČET EXTREMNÍCH HODNOT.

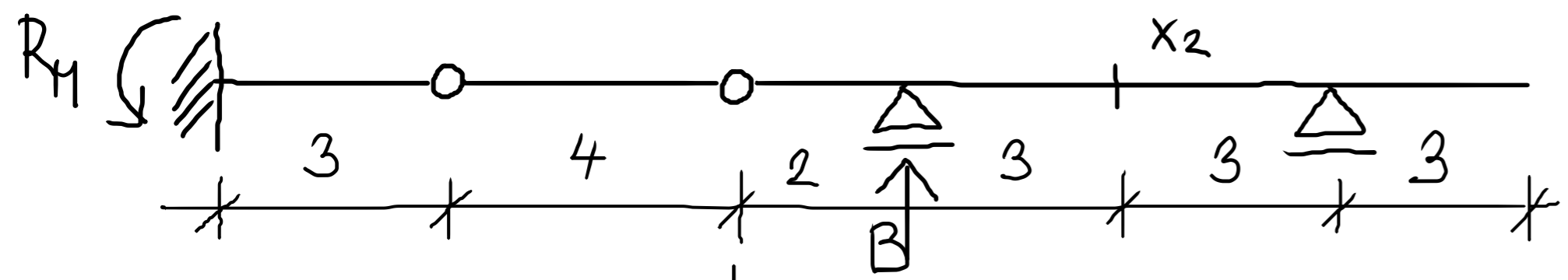

B

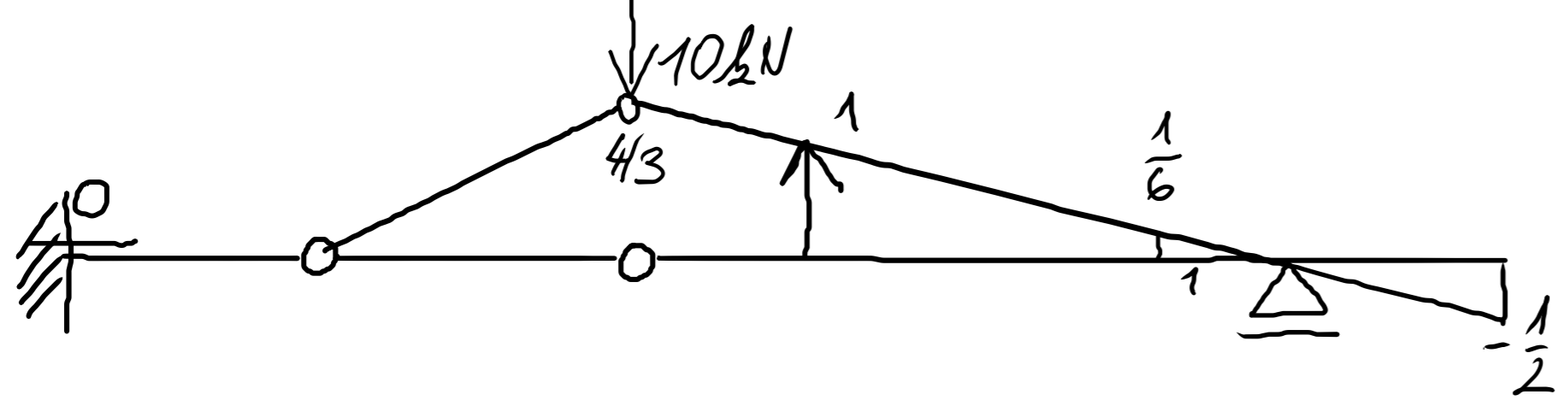

R_H

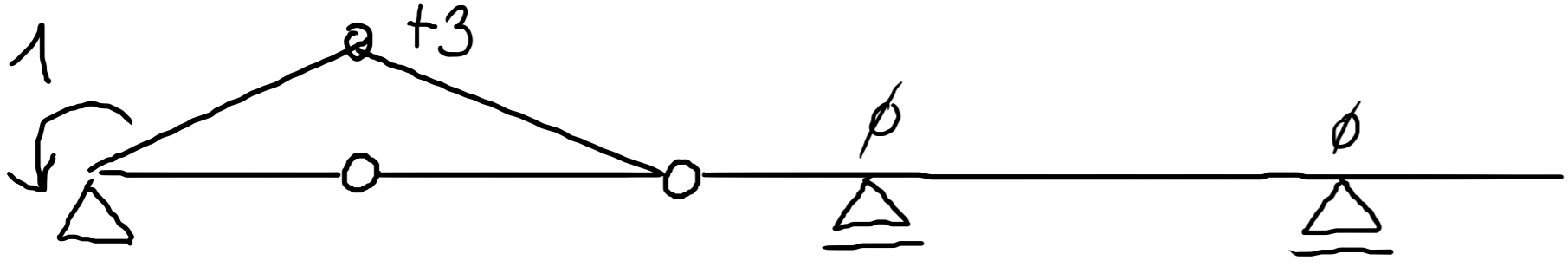

V_{x2}

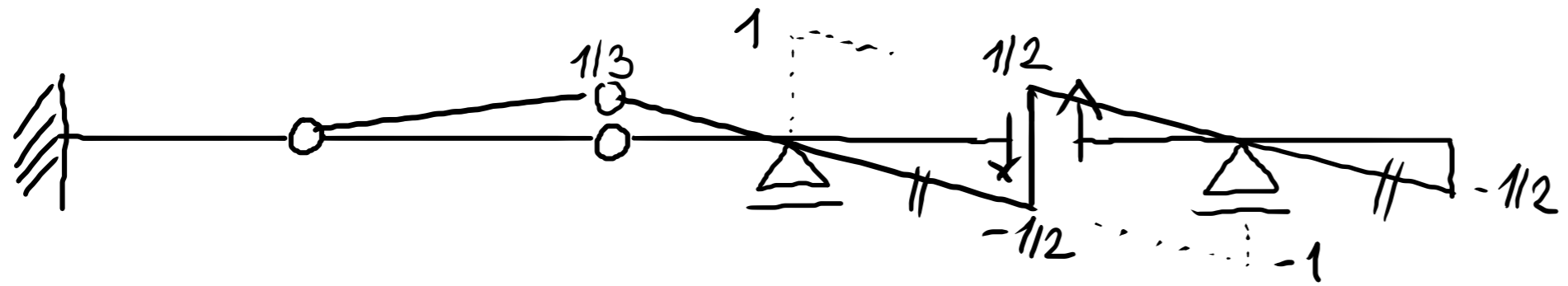

M_{x2}

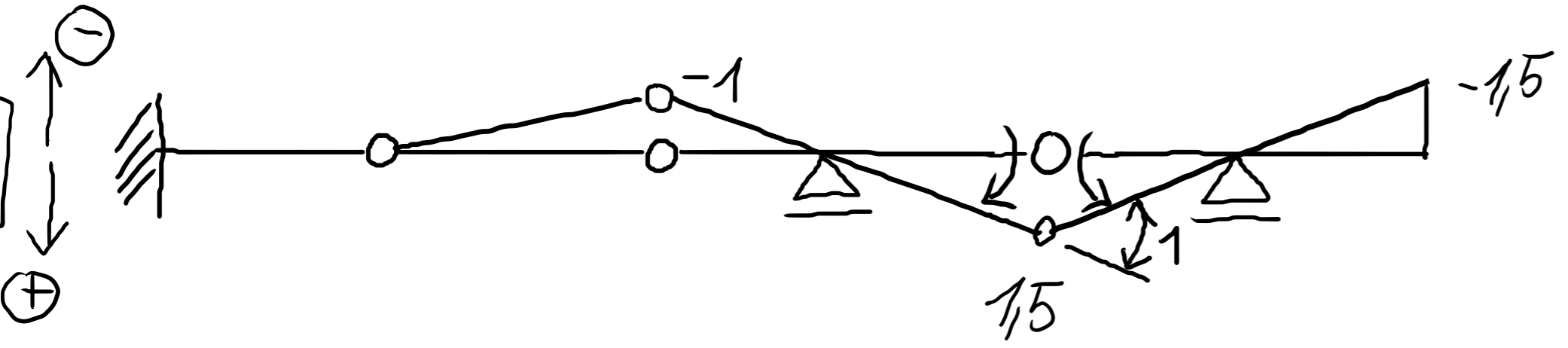

$$B_{min} = 10 \cdot \left(-\frac{1}{2}\right) + 5 \cdot 3 \cdot \frac{1}{2} \left(-\frac{1}{2}\right) = -8,75 \text{ kN}$$

$$B_{max} =$$

PŘÍČINKOVÉ ČÁRY - UMÍSTĚNÍ ZATIŽENÍ

UMÍSTĚTE JEDNU SILU VELIKOSTI 10kN
A SPOJITÁ ZATIŽENÍ VELIKOSTI 5kNm
PRO ÚPOČET EXTREMNÍCH HODNOT.

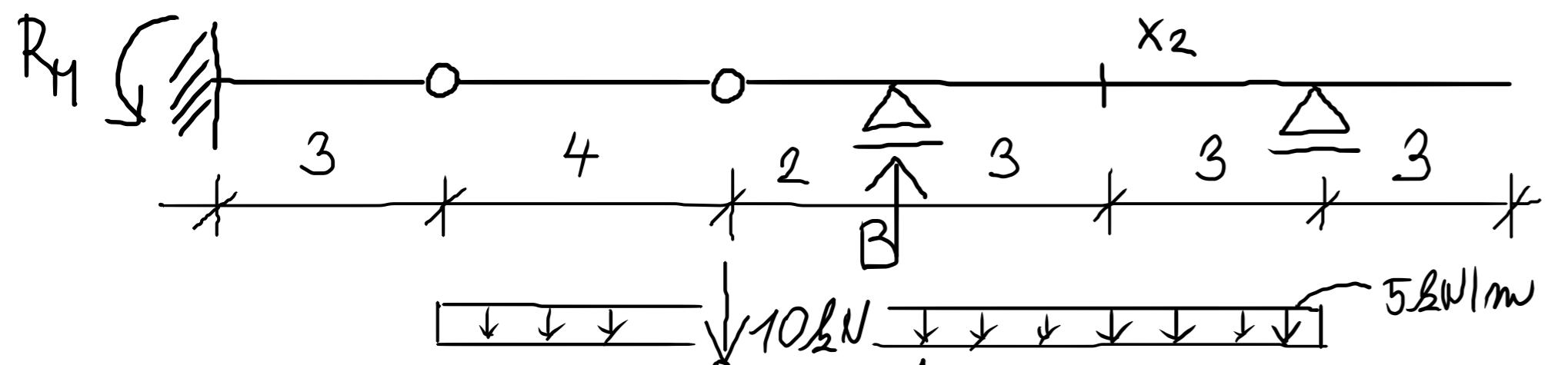

B

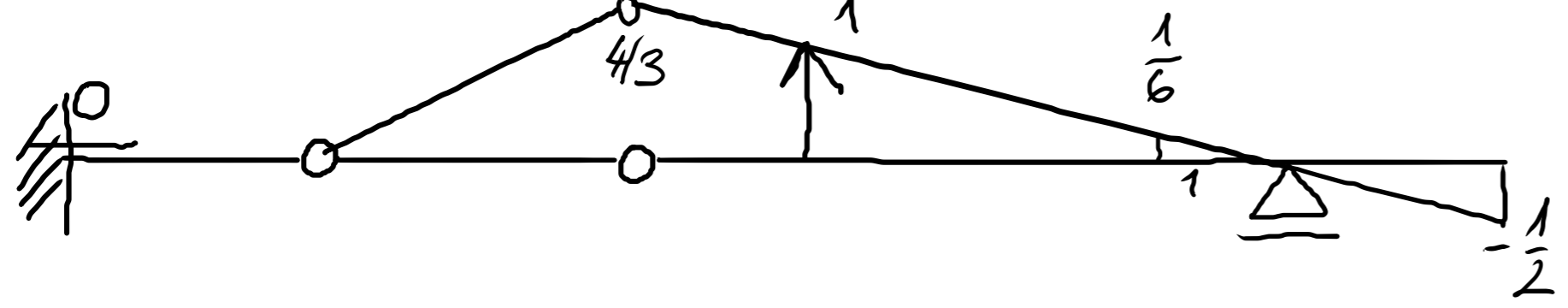

R_H

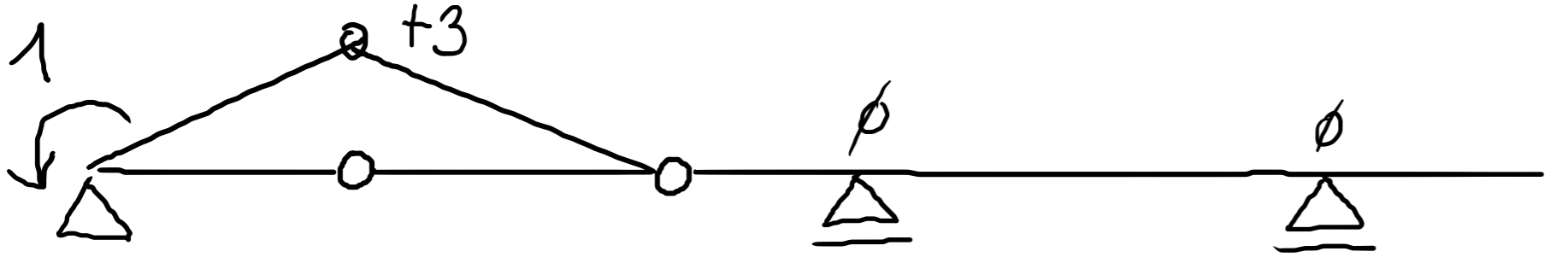

V_{x2}

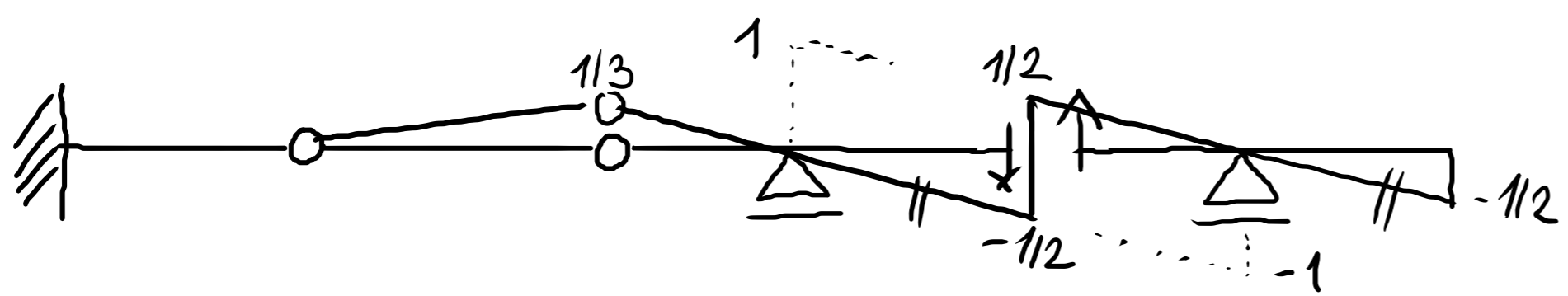

M_{x2}

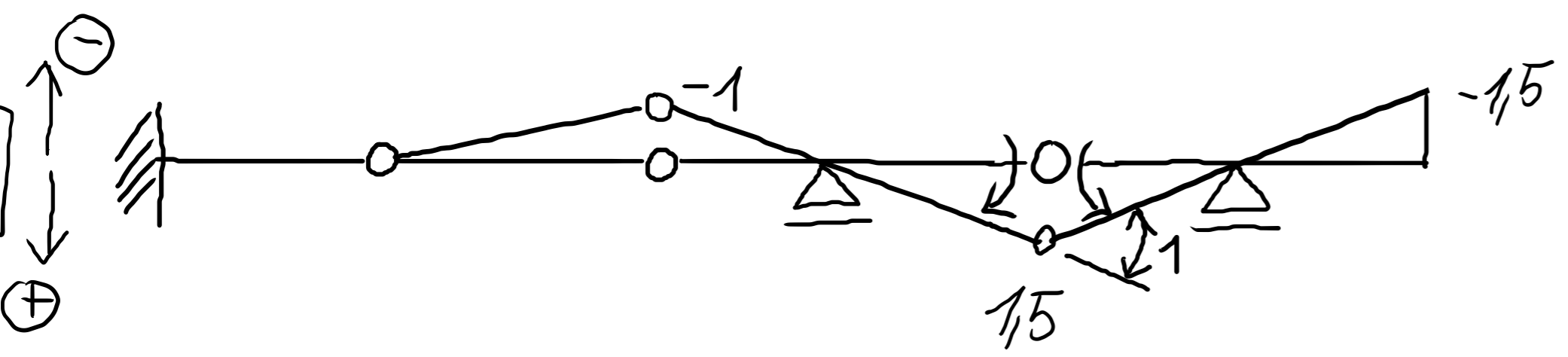

$$B_{min} = 10 \cdot \left(-\frac{1}{2}\right) + 5 \cdot 3 \cdot \frac{1}{2} \left(-\frac{1}{2}\right) = -8,75 \text{ kN}$$

$$B_{max} =$$

PŘÍČINKOVÉ ČÁRY - UMÍSTĚNÍ ZATÍŽENÍ

UMÍSTĚTE JEDNU SILU VELIKOSTI 10kN
A SPOJITÁ ZATÍŽENÍ VELIKOSTI 5kNm
PRO VÝPOČET EXTREMNÍCH HODNOT.

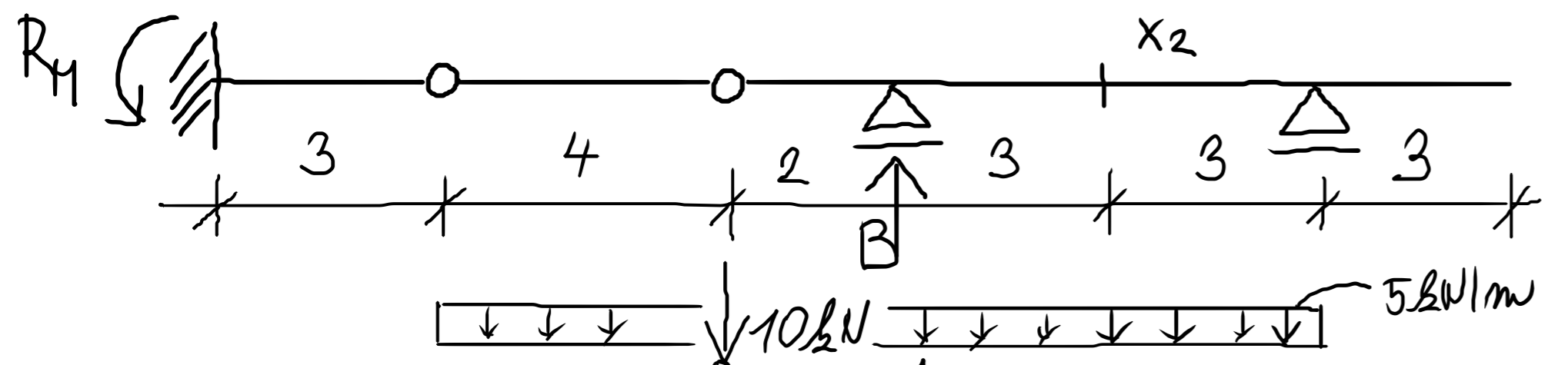

B

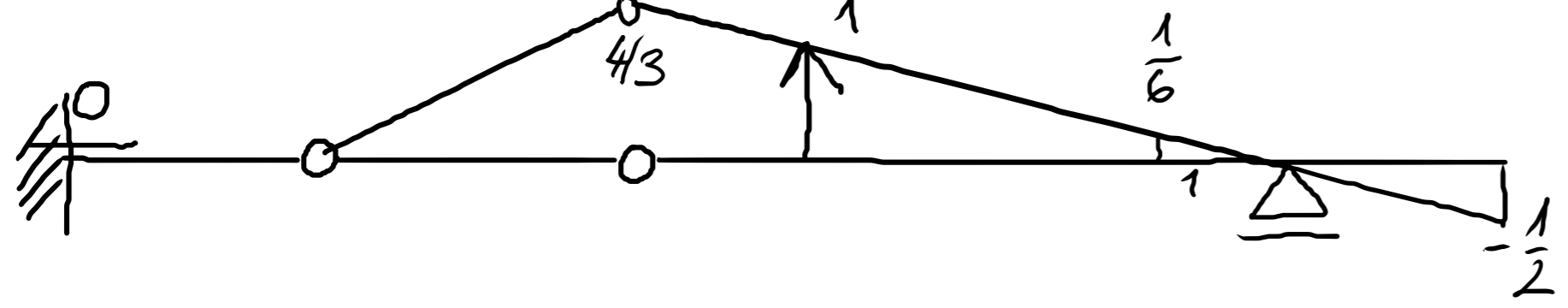

$$B_{min} = 10 \cdot \left(-\frac{1}{2}\right) + 5 \cdot 3 \cdot \frac{1}{2} \left(-\frac{1}{2}\right) = -8,75 \text{ kN}$$

$$B_{max} = 10 \cdot \left(\frac{4}{3}\right) + \frac{1}{2} \cdot \frac{4}{3} \cdot 12 \cdot 5 = 53,3 \text{ kN}$$

D_H

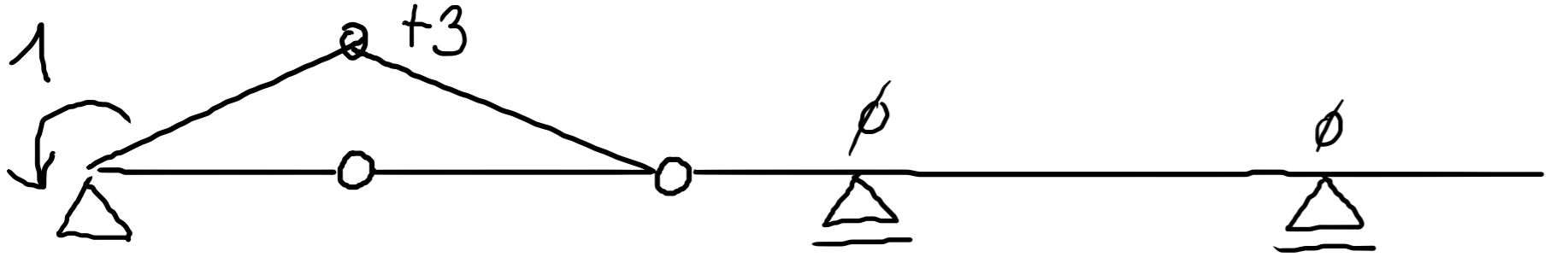

V_{x2}

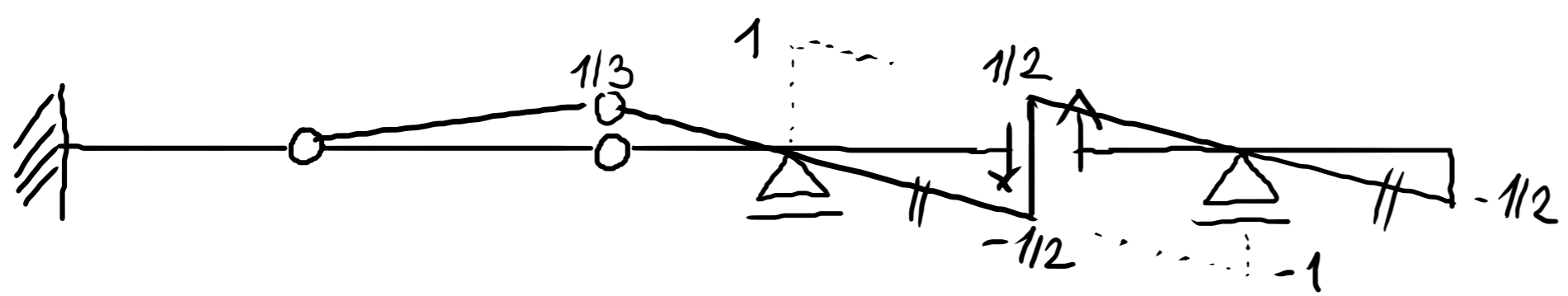

M_{x2}

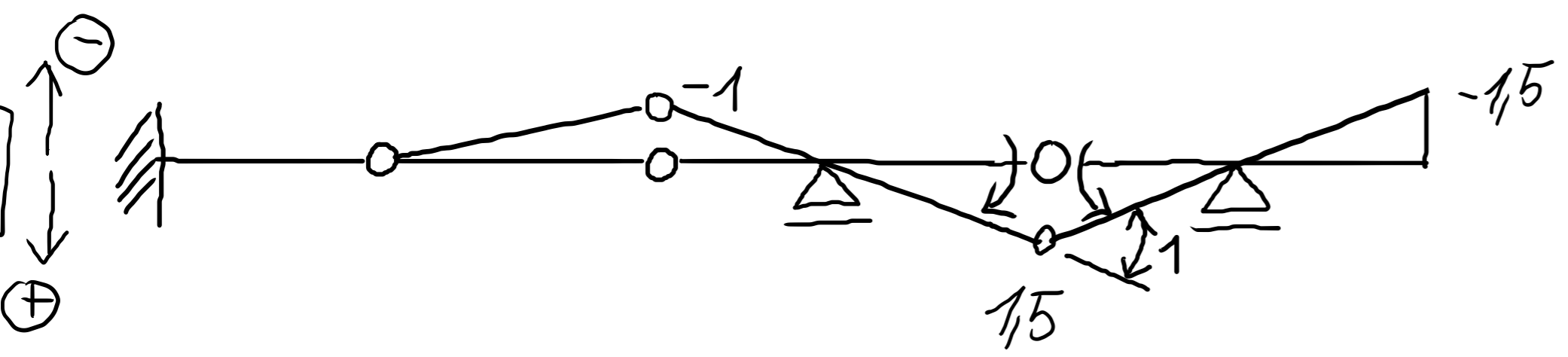

PŘÍČINKOVÉ ČÁRY - UMÍSTĚNÍ ZATIŽENÍ

UMÍSTĚTE JEDNU SILU VELIKOSTI 10kN
A SPOJITÁ ZATIŽENÍ VELIKOSTI 5kNm
PRO ÚPOČET EXTREMNÍCH HODNOT.

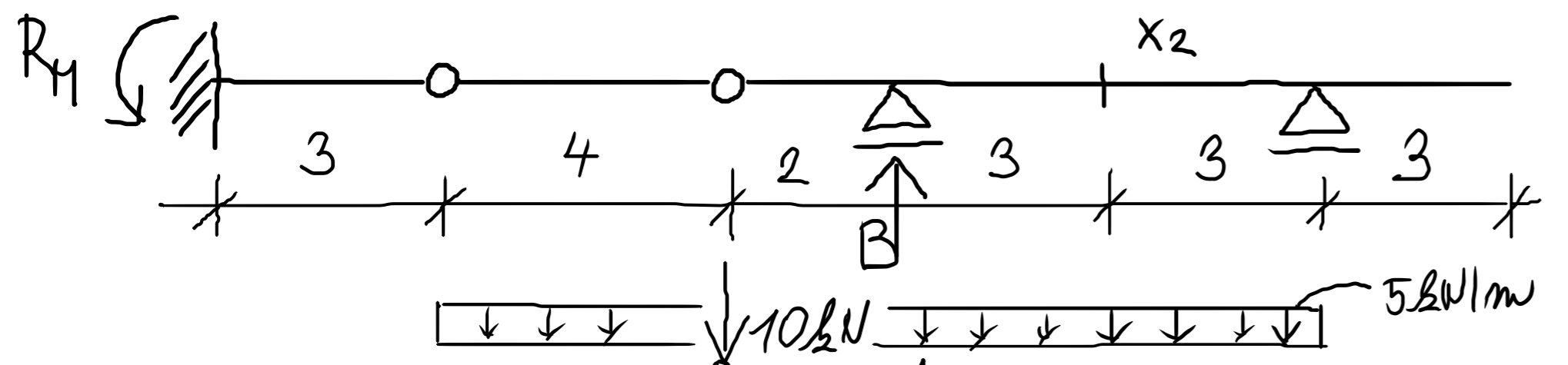

B

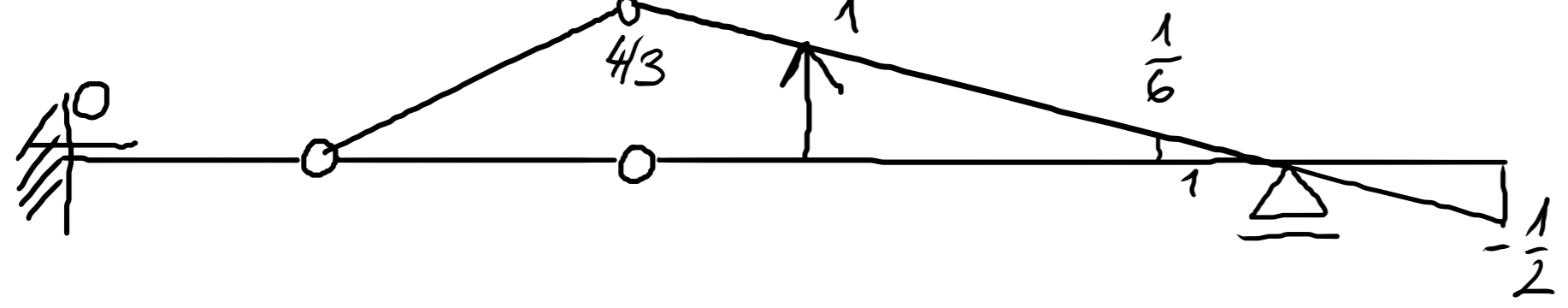

R_H

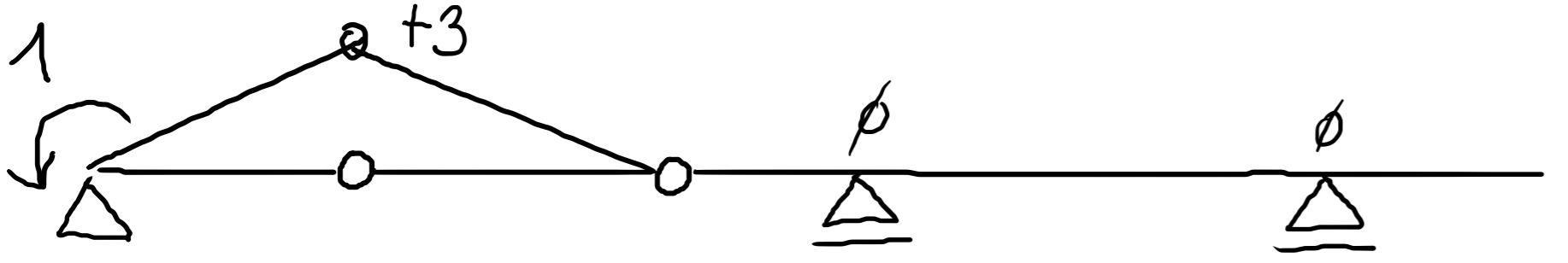

V_{x2}

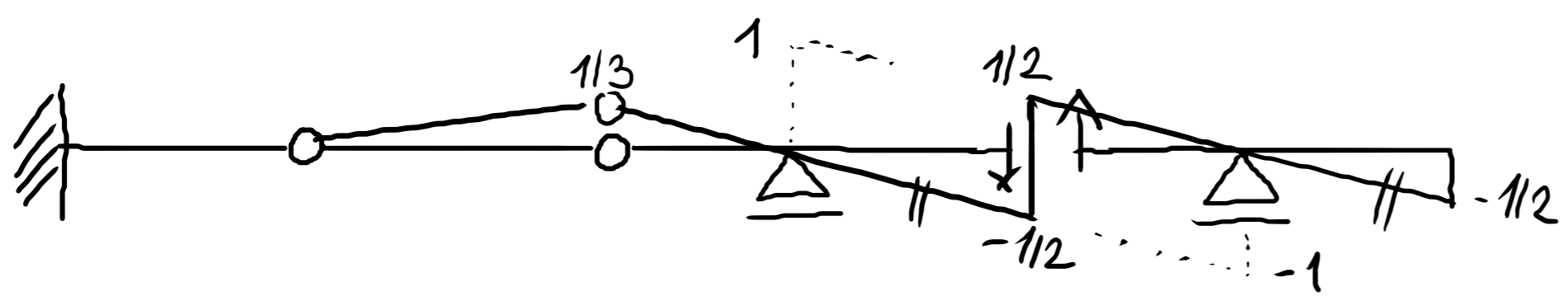

M_{x2}

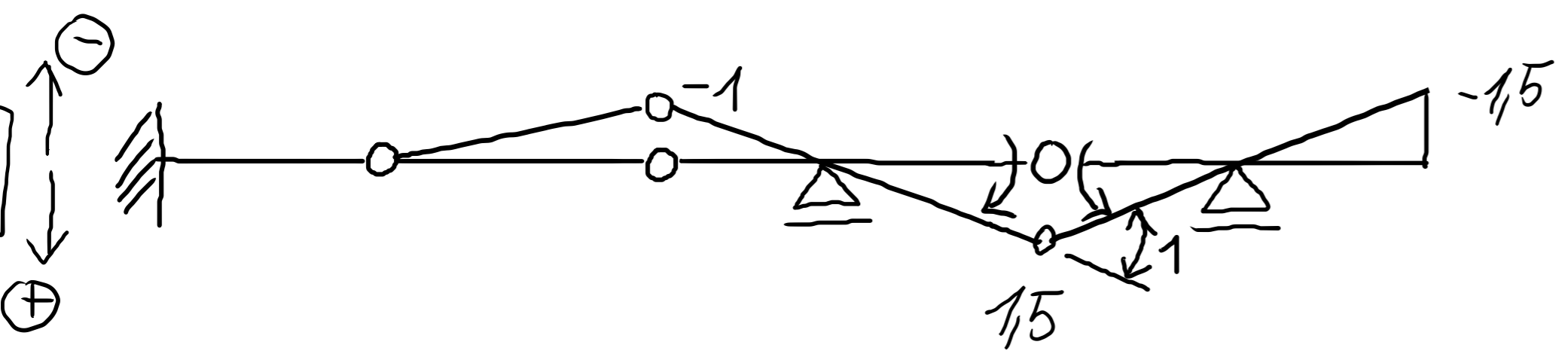

$$B_{min} = 10 \cdot \left(-\frac{1}{2}\right) + 5 \cdot 3 \cdot \frac{1}{2} \left(-\frac{1}{2}\right) = -8,75 \text{ kN}$$

$$B_{max} = 10 \cdot \left(\frac{4}{3}\right) + \frac{1}{2} \cdot \frac{4}{3} \cdot 12 \cdot 5 = 53,3 \text{ kN}$$

$$R_{H, min} = 0 \text{ kN}$$

$$R_{H, max} = 82,5 \text{ kN}$$

$$V_{x2, min} = -12,5 \text{ kN}$$

$$V_{x2, max} = 13,75 \text{ kN}$$

$$M_{x2, min} = -41,25 \text{ kNm}$$

$$M_{x2, max} = 37,5 \text{ kNm}$$