

V

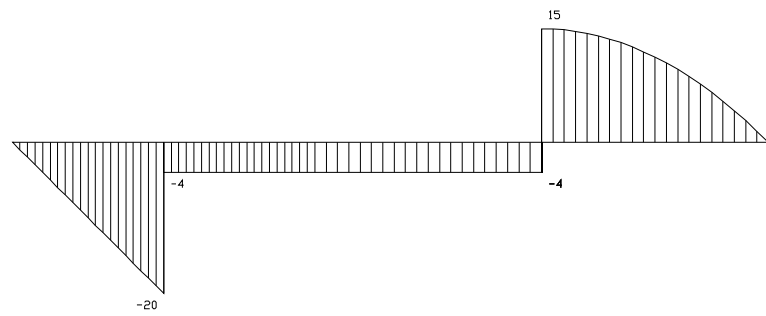

M

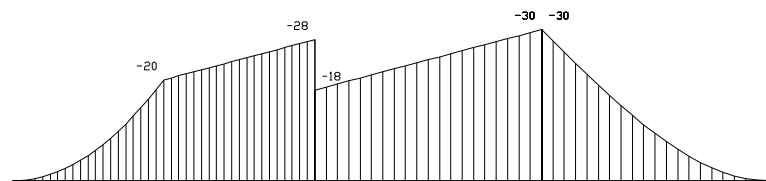

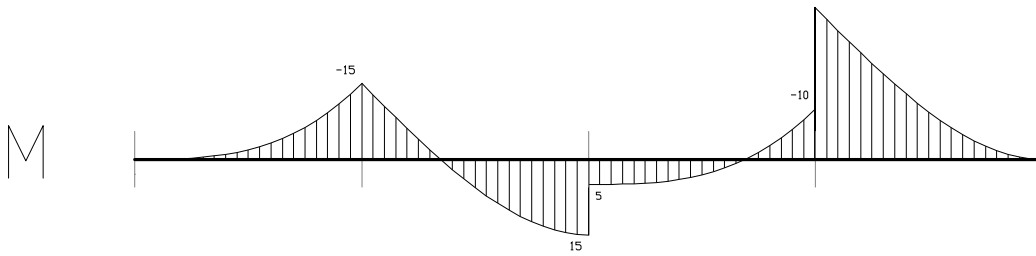
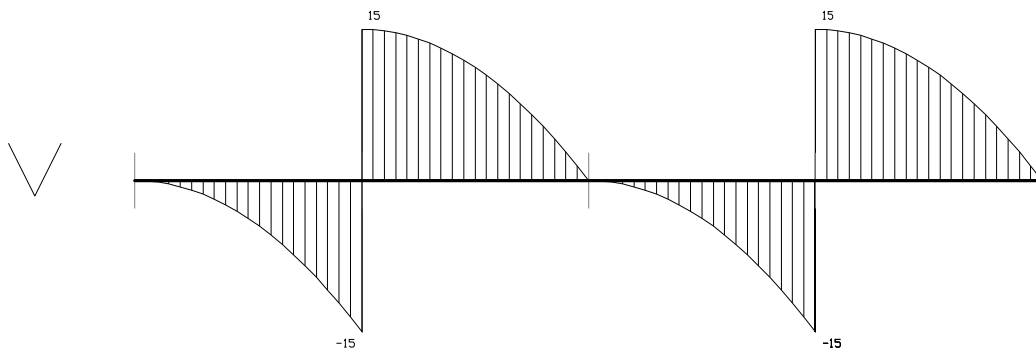
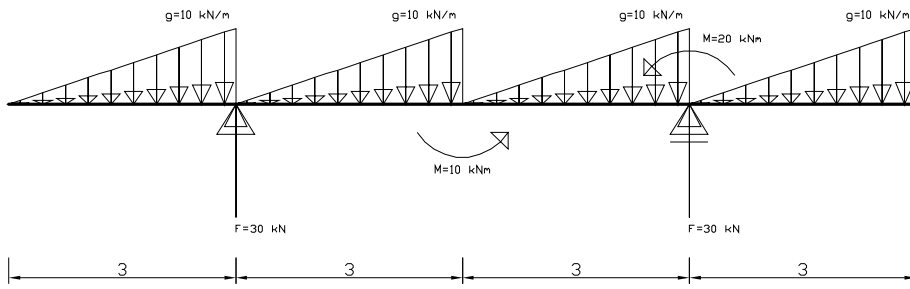

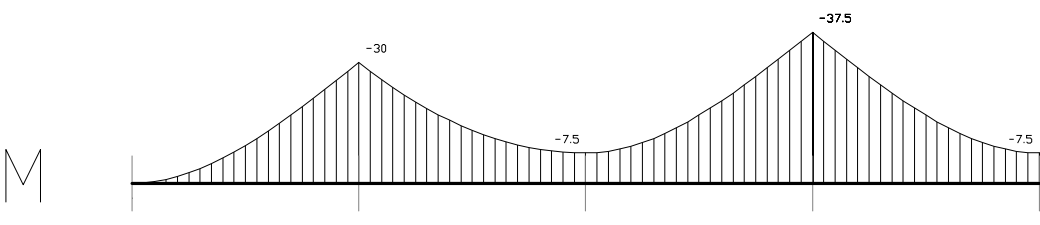
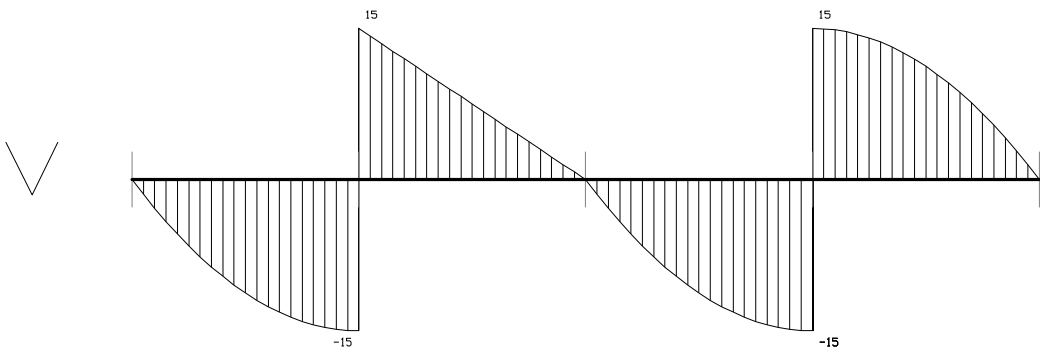
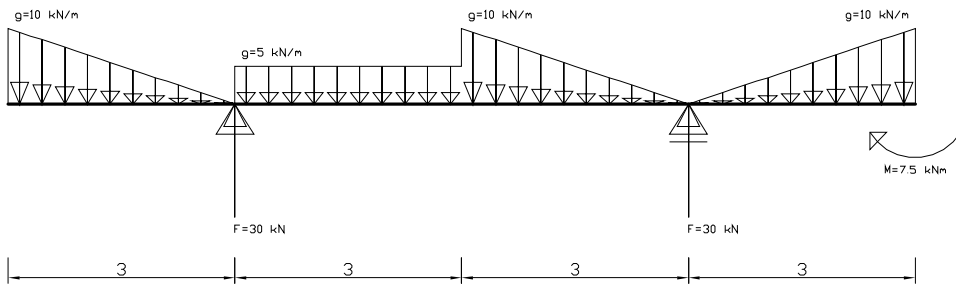

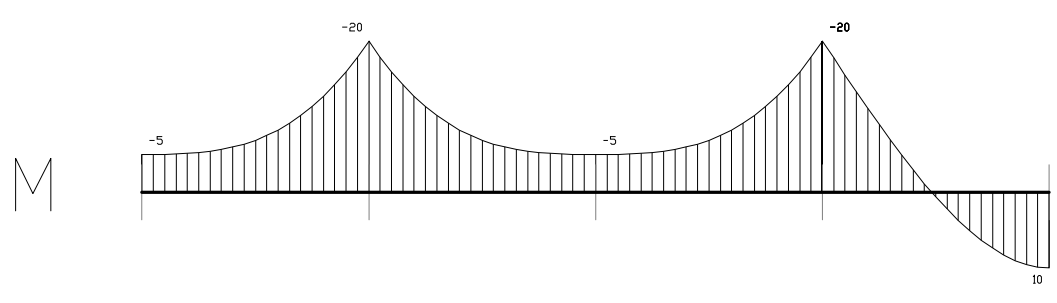
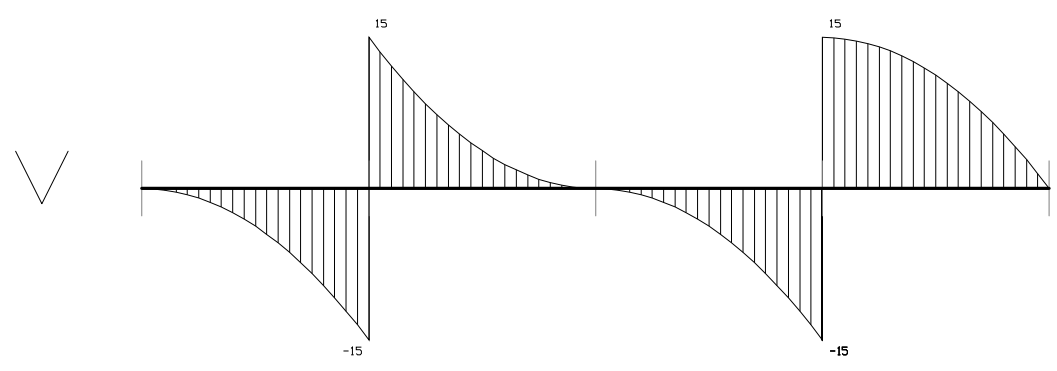
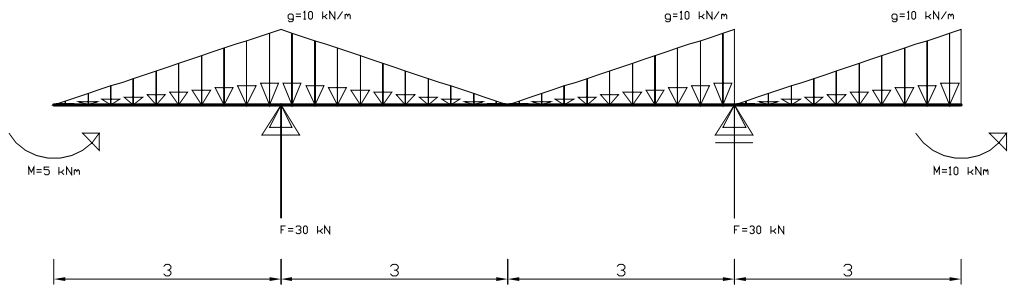

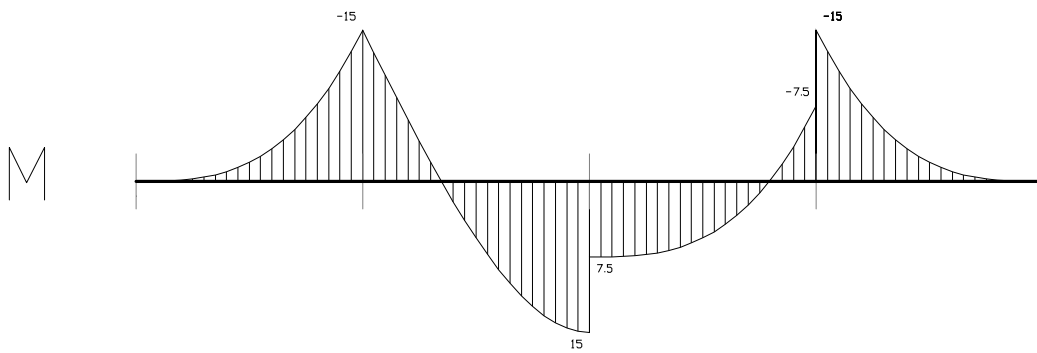
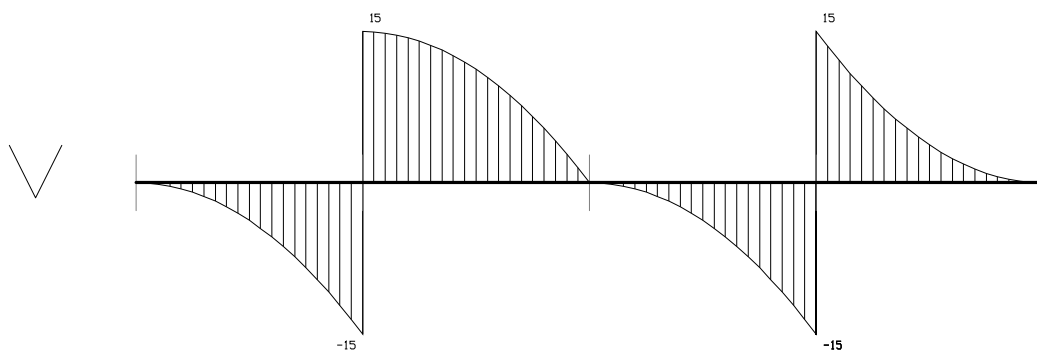
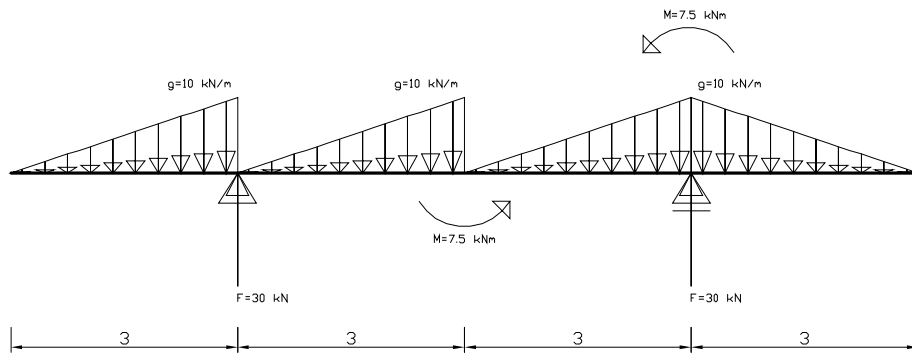

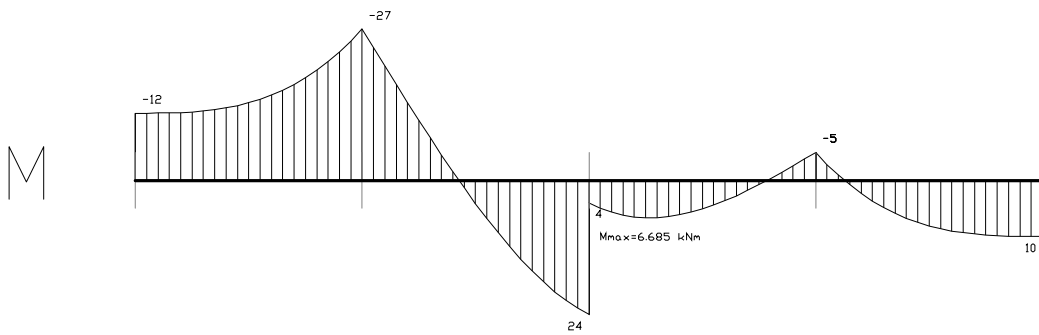
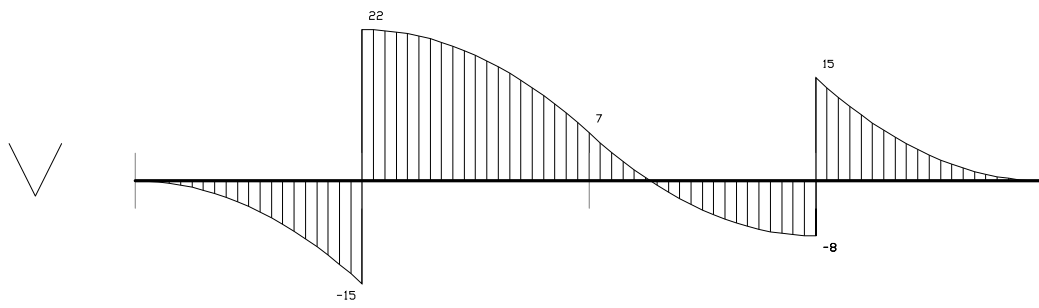
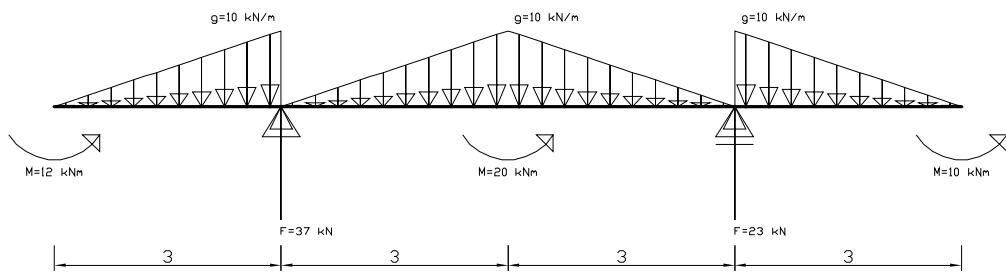

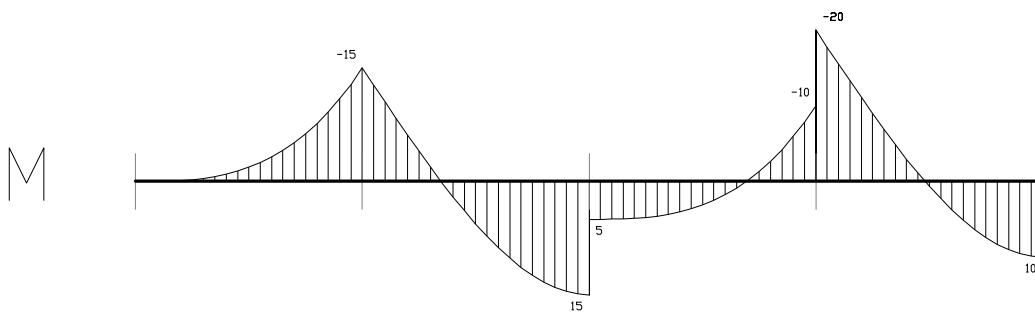
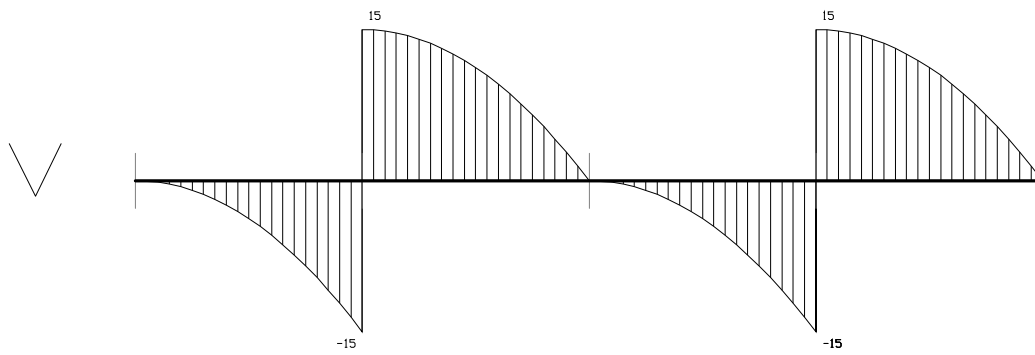
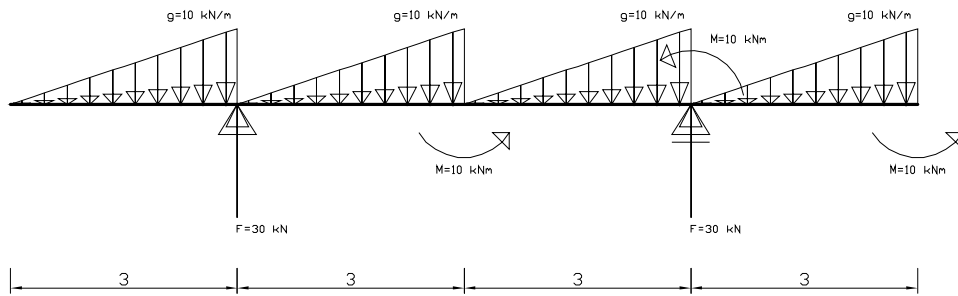

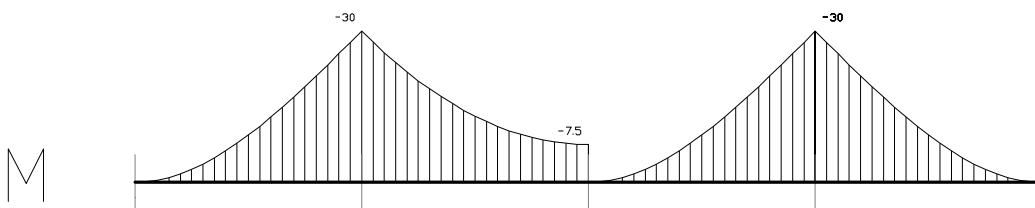
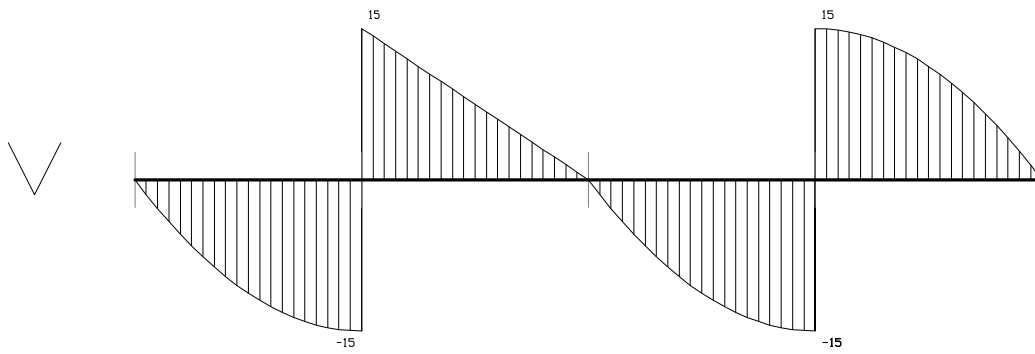
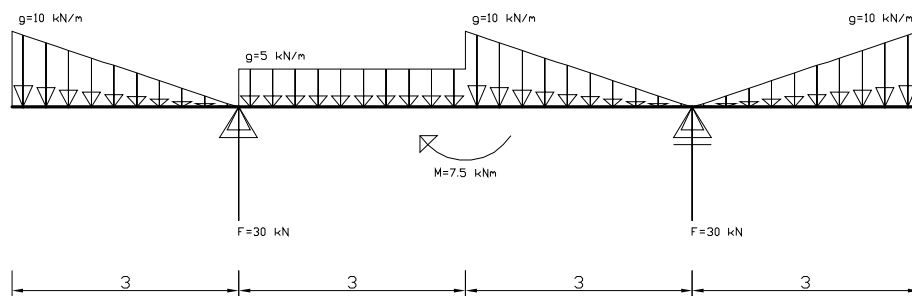



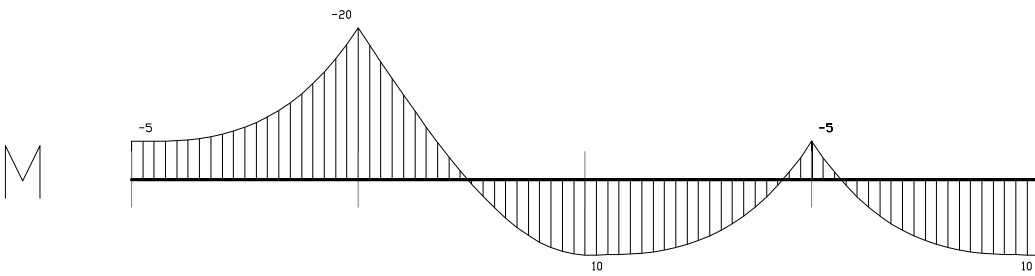
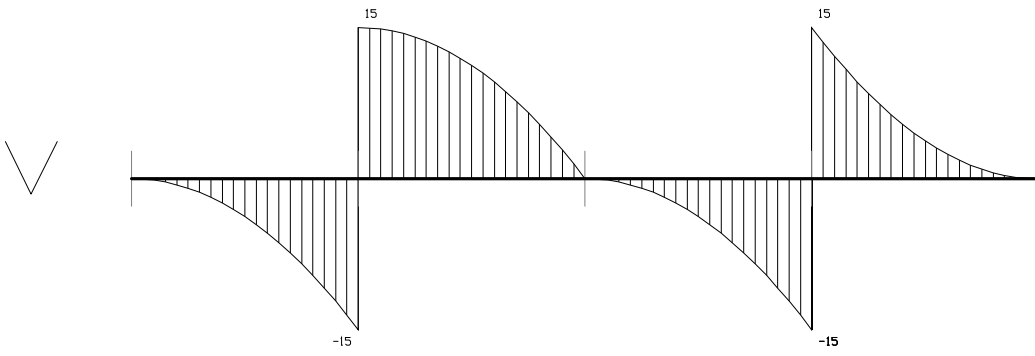
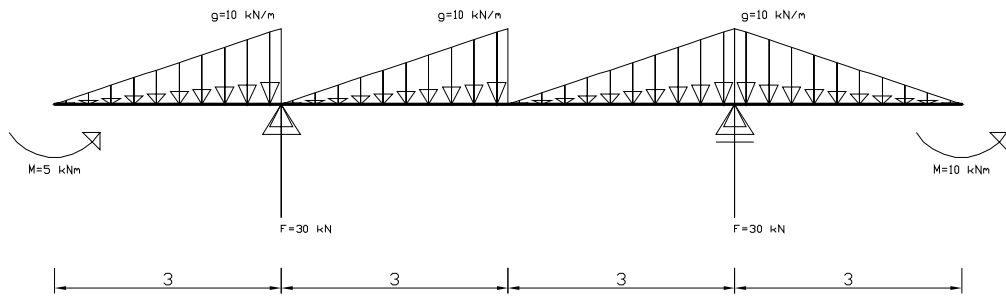

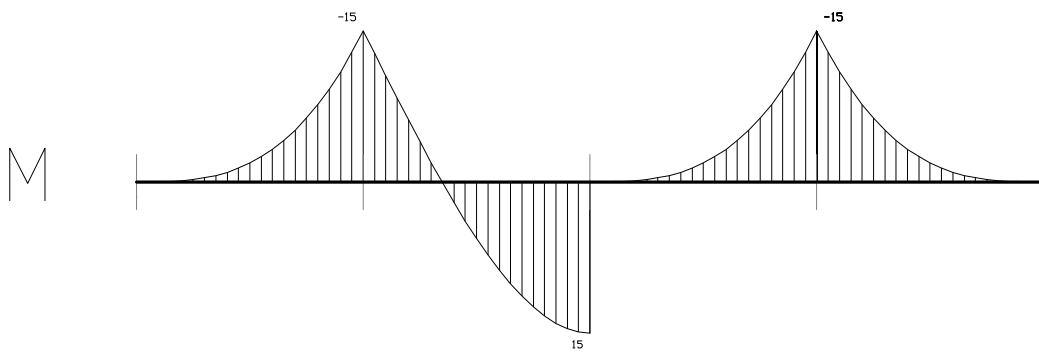
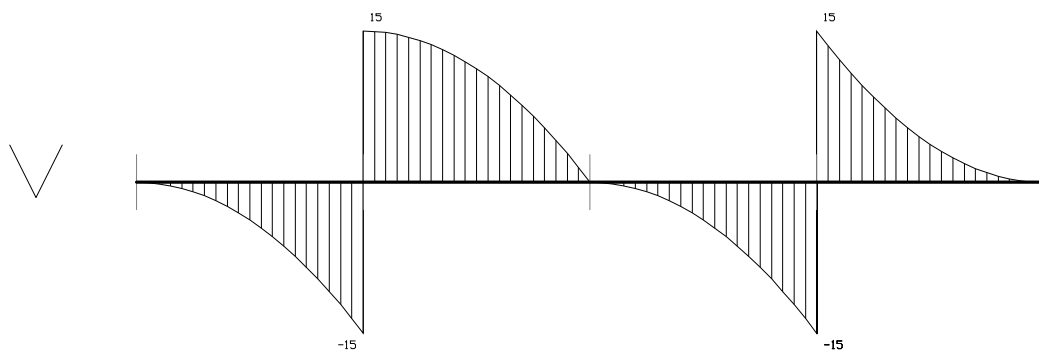
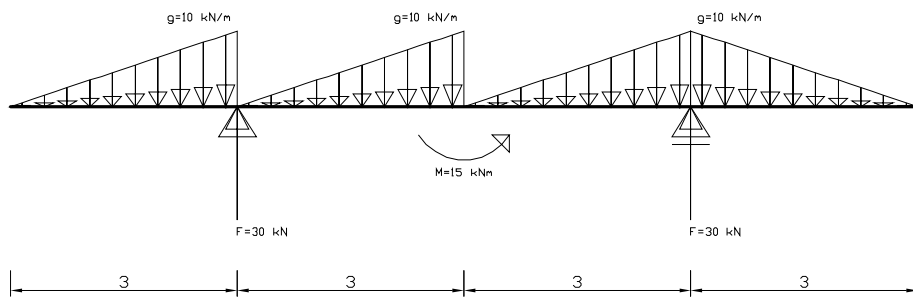

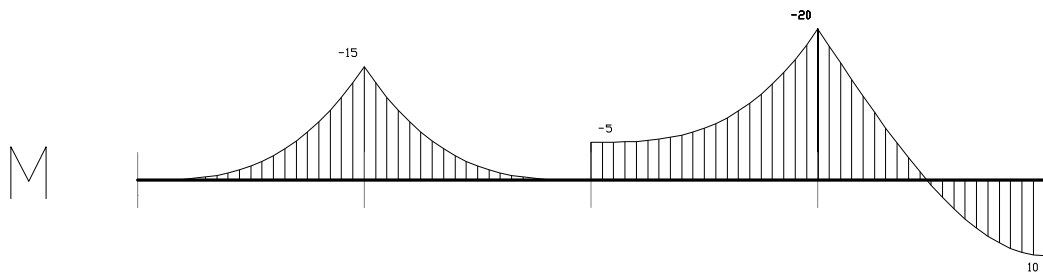
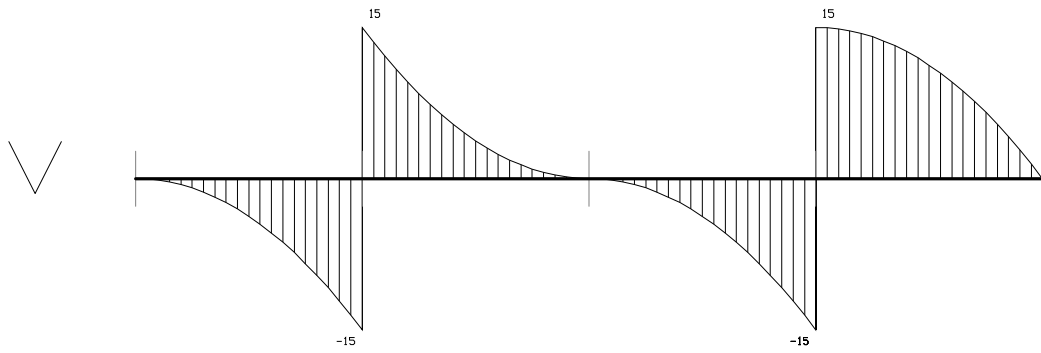
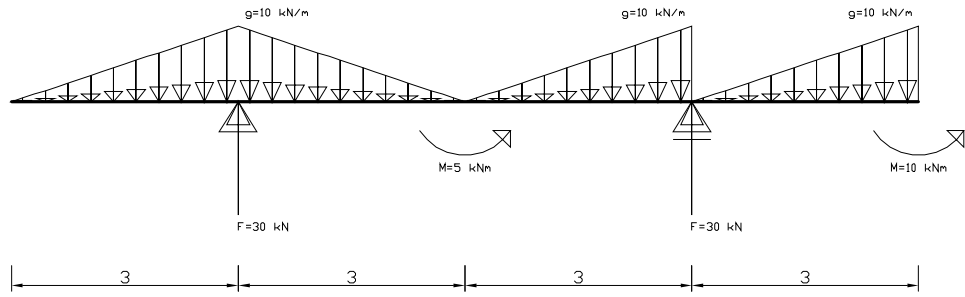

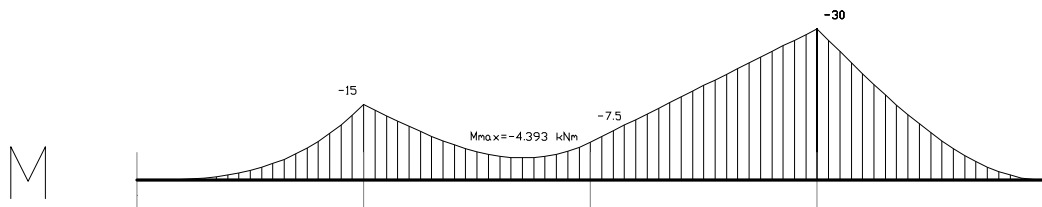
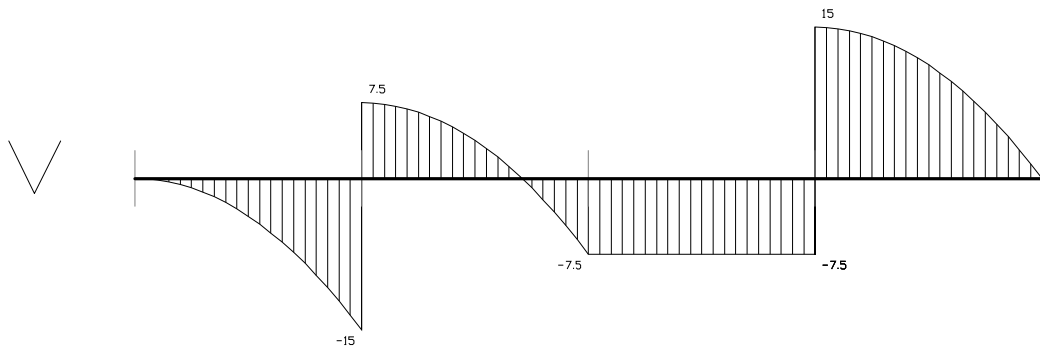
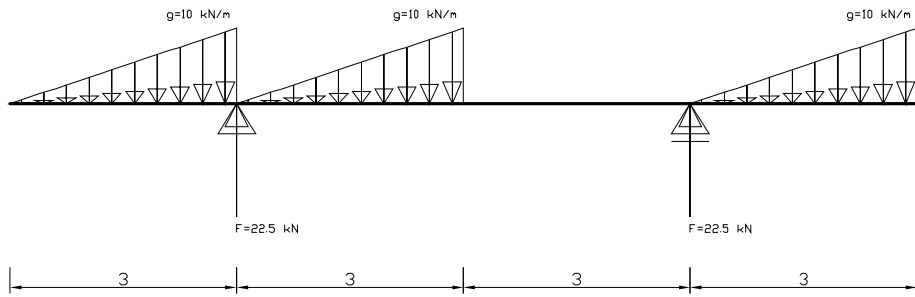

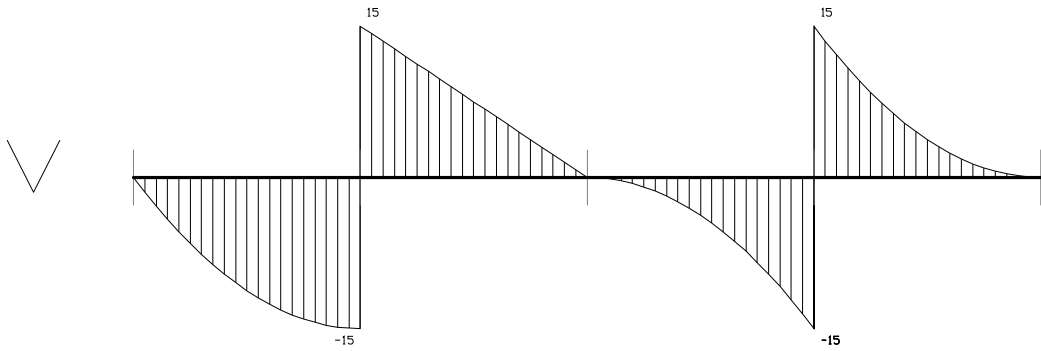
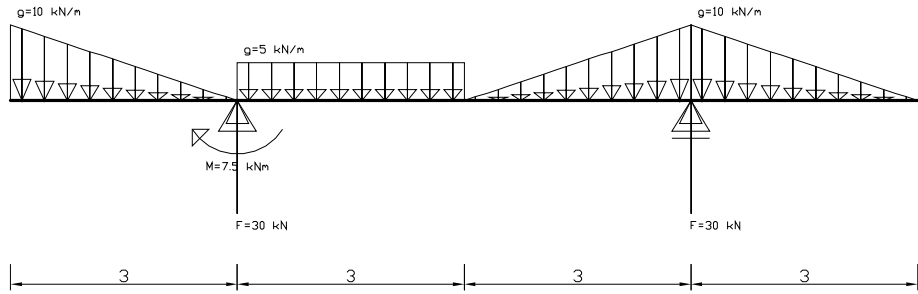

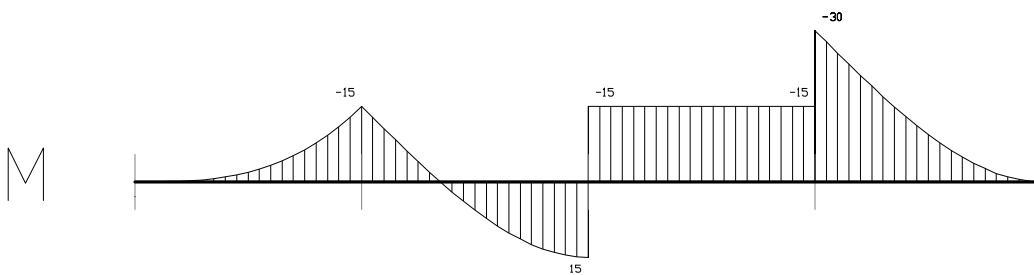
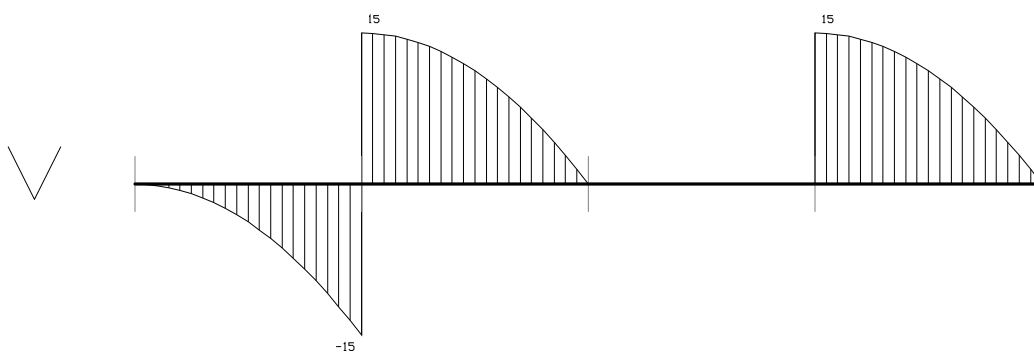
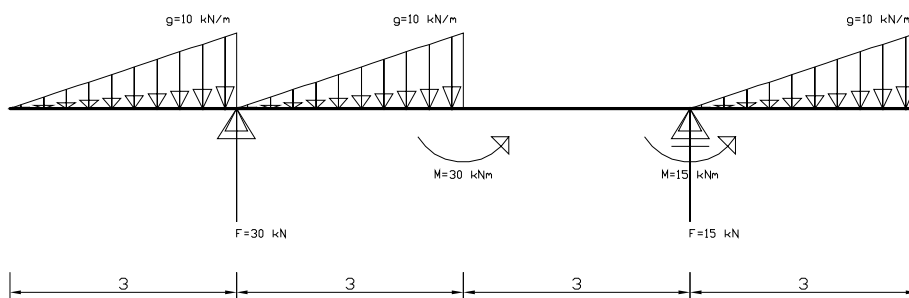

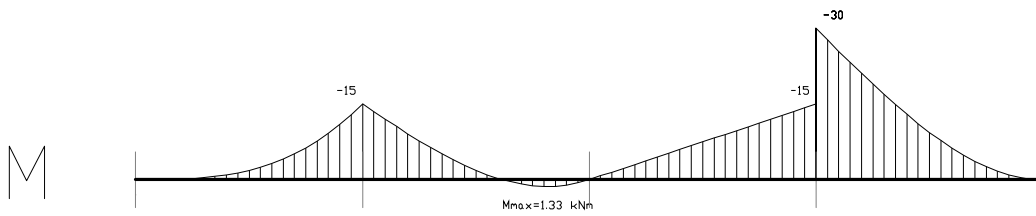
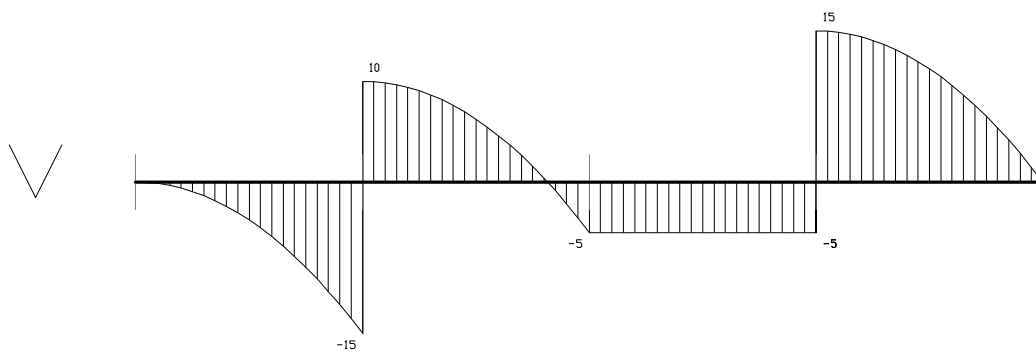
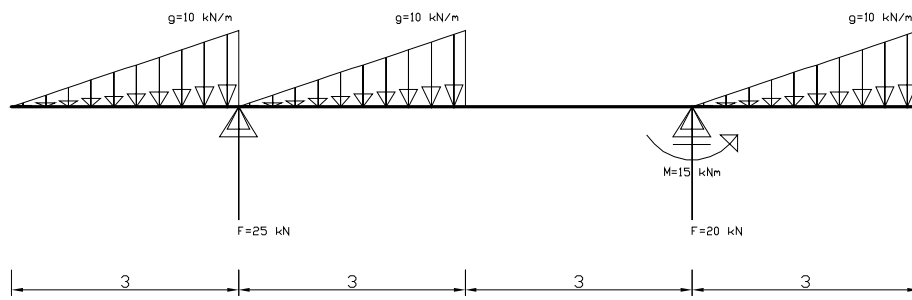

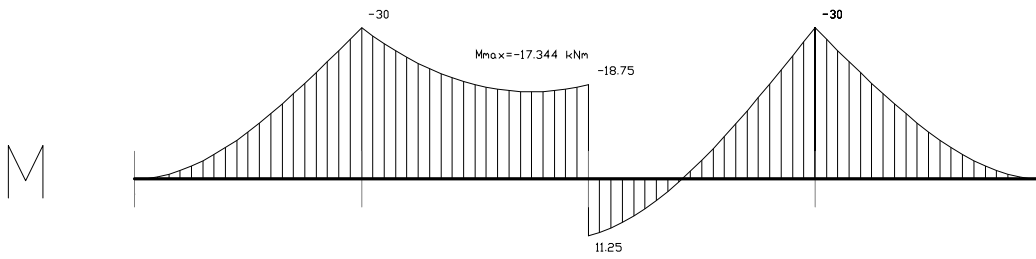
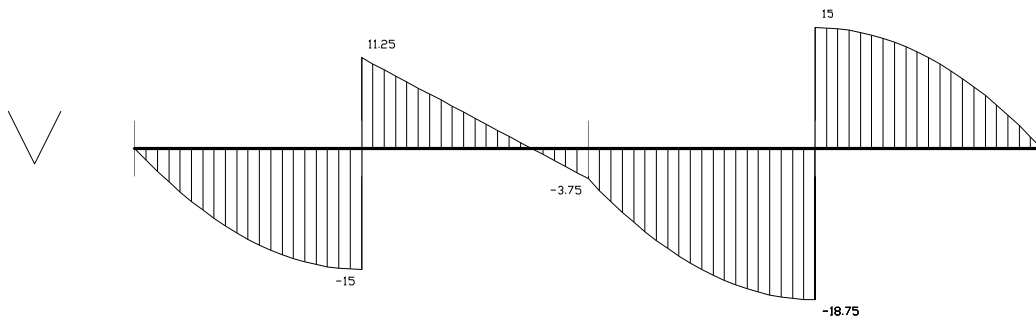
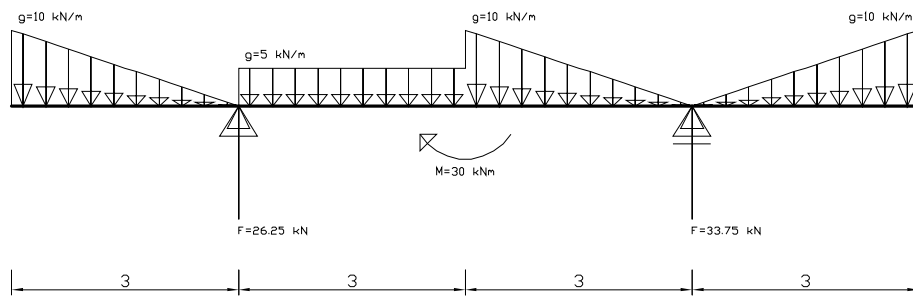



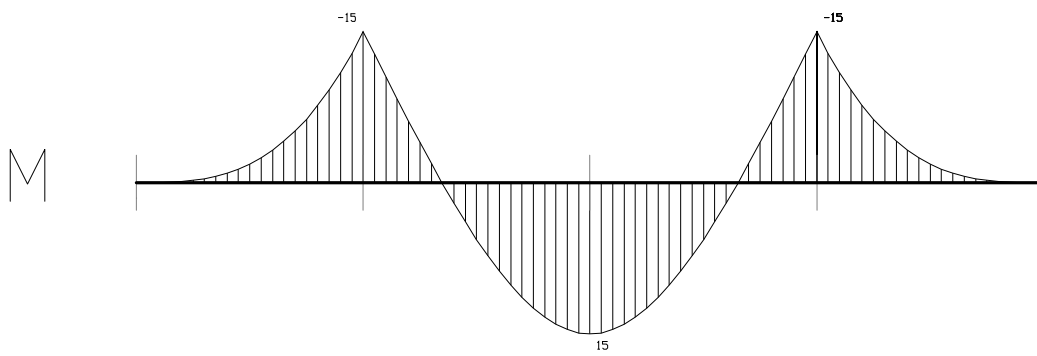
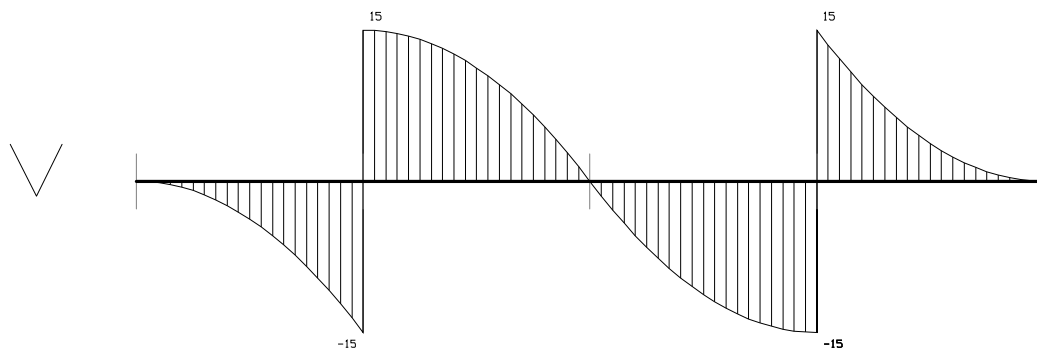
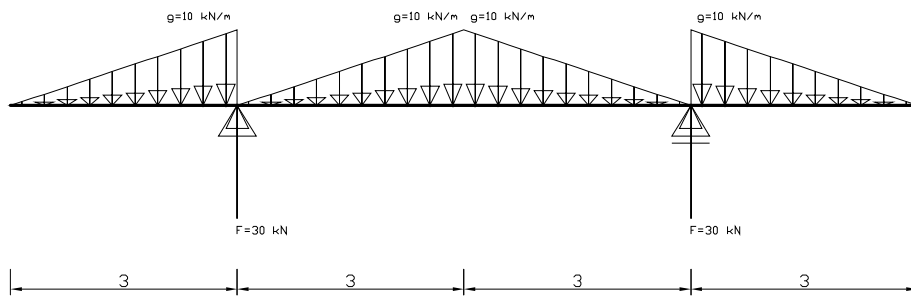

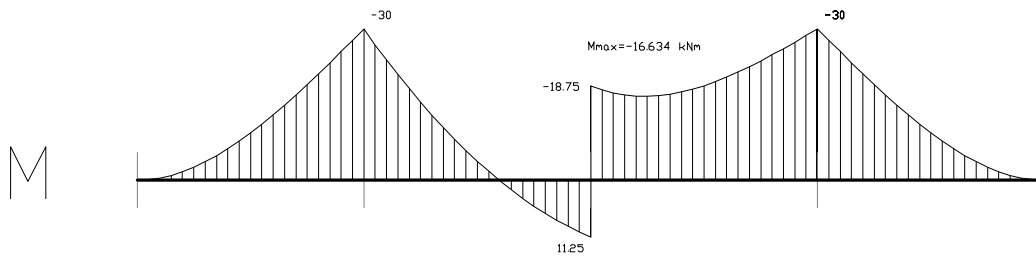
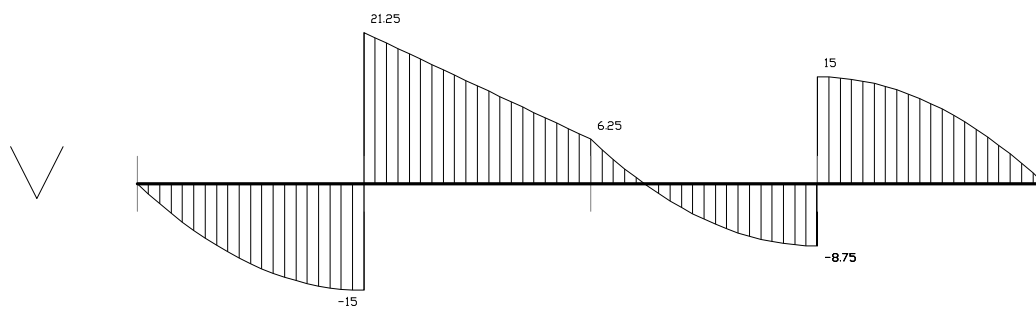
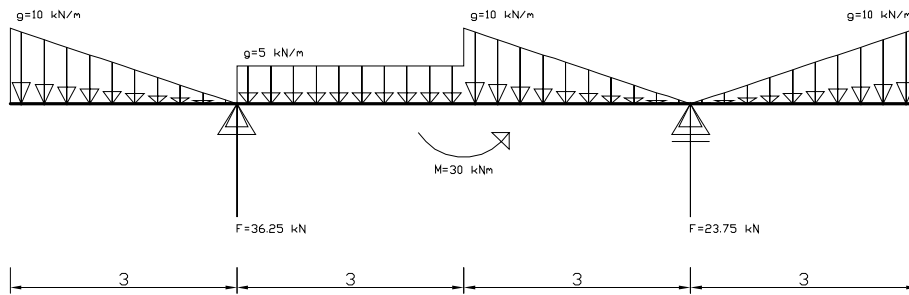

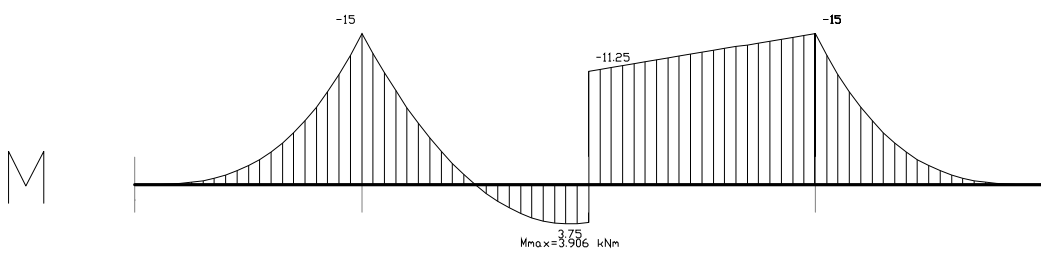
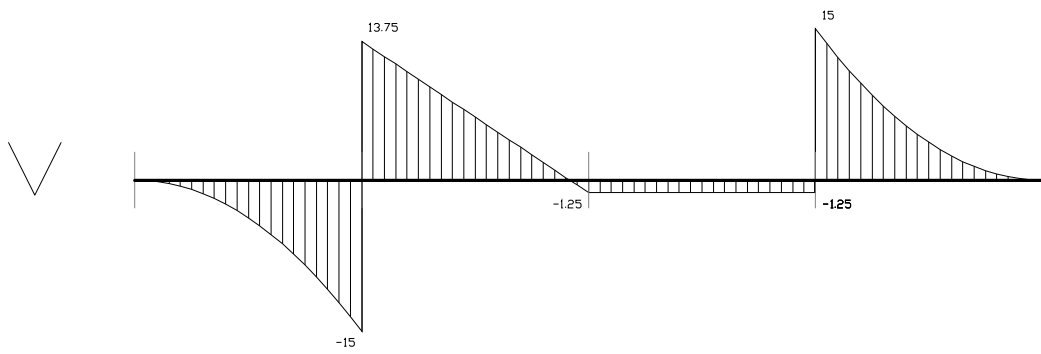
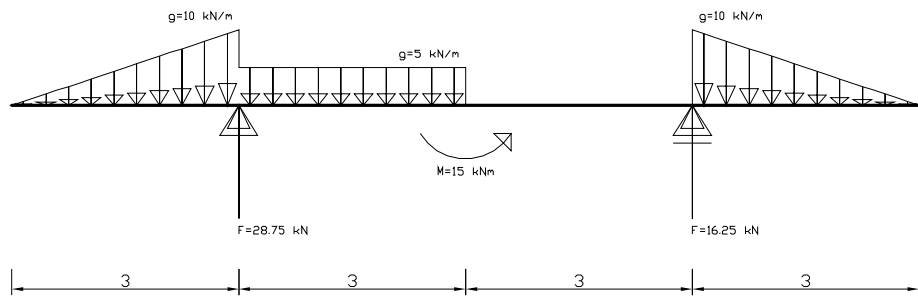

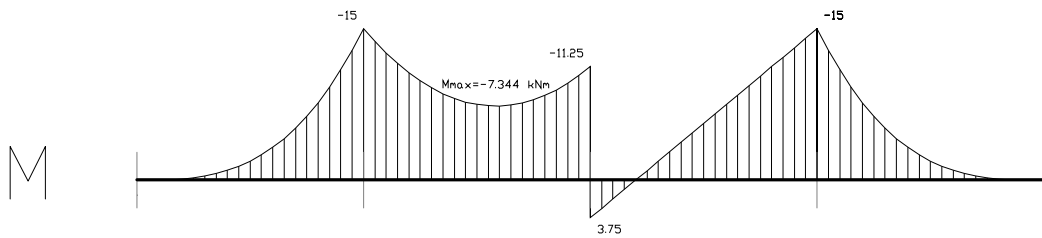
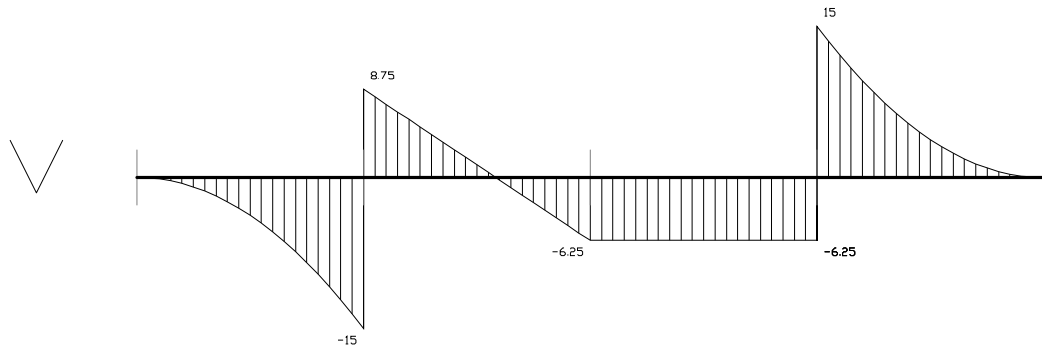
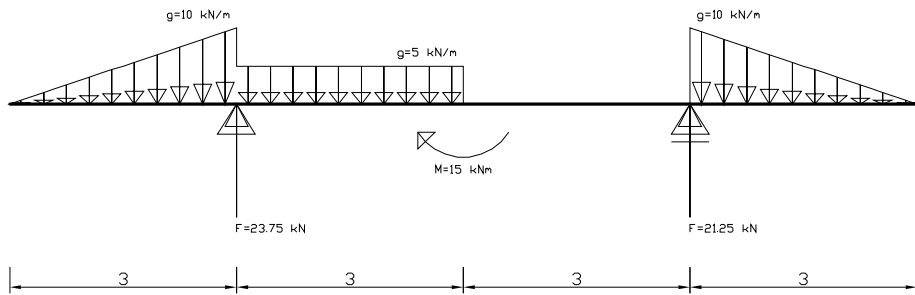

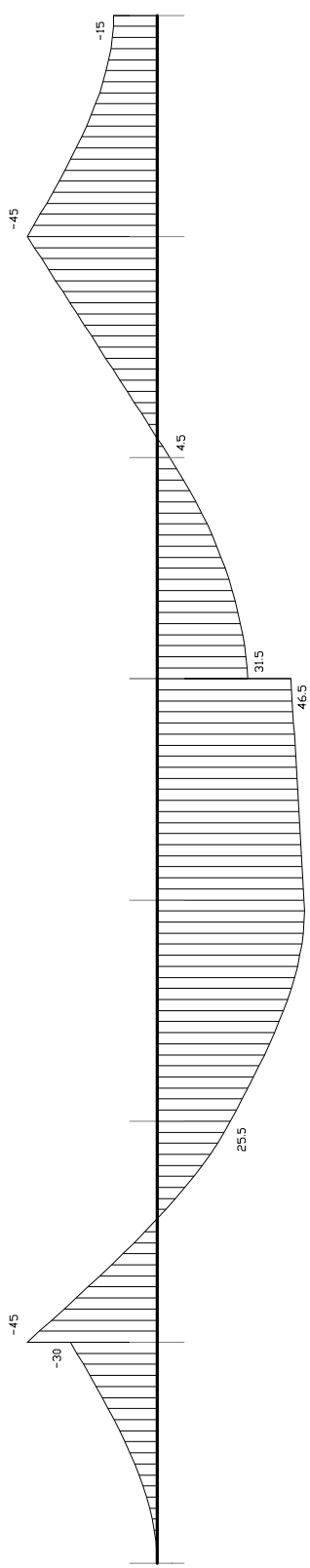
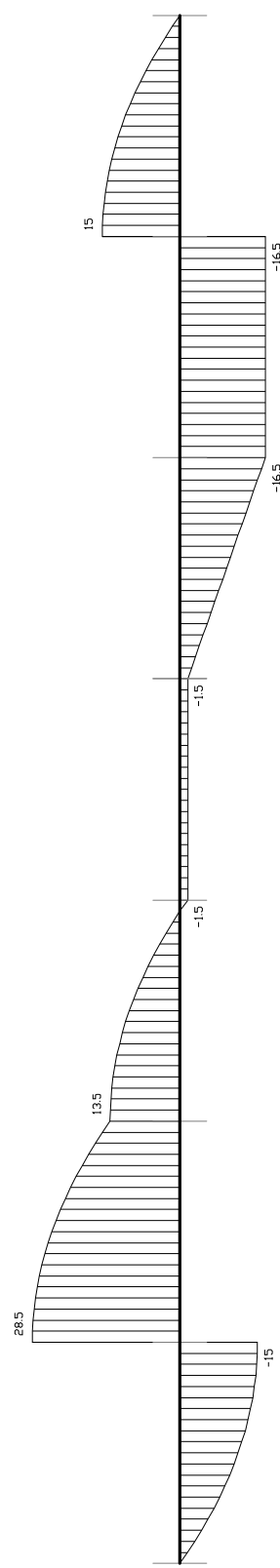
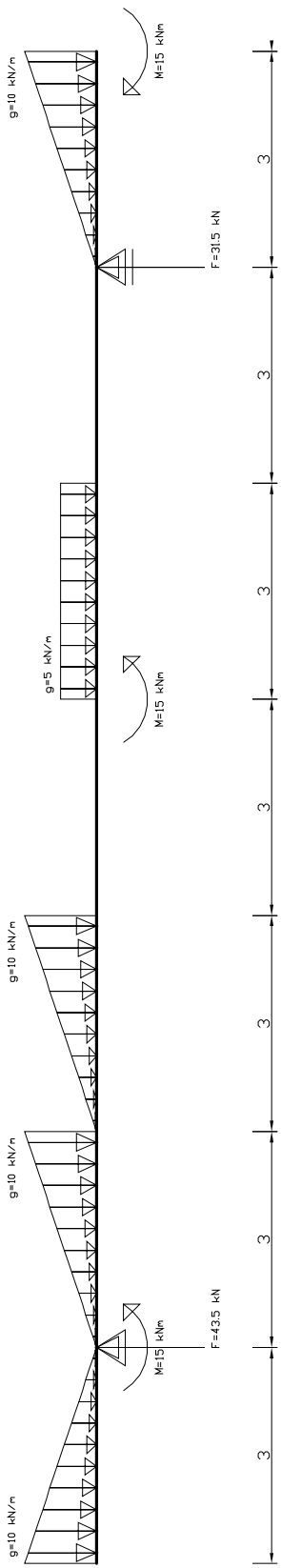

Max = 51.114 kNm

